



Raccordi ARANCIO



Curva Aperta 45° (storta)



Codice	SubCodice	Riferimenti	Listino	U.M.	Conf.
CA32		D. 32	Richiedere	1	10
CA40		D. 40	Richiedere	1	10
CA50		D. 50	Richiedere	1	10
CA63		D. 63	Richiedere	1	10
CA80		D. 80	Richiedere	1	10
CA100		D. 100	Richiedere	1	10
CA125		D. 125	Richiedere	1	10
CA140		D. 140	Richiedere	1	10
CA160		D. 160	Richiedere	1	10
CA200		D. 200	Richiedere	1	10

Curva Chiusa 87° (gomito)



Codice	SubCodice	Riferimenti	Listino	U.M.	Conf.
CC32		D. 32	Richiedere	1	10
CC40		D. 40	Richiedere	1	10
CC50		D. 50	Richiedere	1	10
CC63		D. 63	Richiedere	1	10
CC80		D. 80	Richiedere	1	10
CC100		D. 100	Richiedere	1	10
CC125		D. 125	Richiedere	1	10
CC140		D. 140	Richiedere	1	10
CC160		D. 160	Richiedere	1	10
CC200		D. 200	Richiedere	1	10

Derivazione (braga) "V" 45°



Codice	SubCodice	Riferimenti	Listino	U.M.	Conf.
BV32		D. 32	Richiedere	1	10
BV40		D. 40	Richiedere	1	10
BV50		D. 50	Richiedere	1	10
BV63		D. 63	Richiedere	1	10
BV80		D. 80	Richiedere	1	10
BV100		D. 100	Richiedere	1	10
BV125		D. 125	Richiedere	1	10
BV140		D. 140	Richiedere	1	10
BV160		D. 160	Richiedere	1	10
BV200		D. 200	Richiedere	1	10

Derivazione (braga) "T" 90°



Codice	SubCodice	Riferimenti	Listino	U.M.	Conf.
BT32		D. 32	Richiedere	1	10
BT40		D. 40	Richiedere	1	10
BT50		D. 50	Richiedere	1	10
BT63		D. 63	Richiedere	1	10
BT80		D. 80	Richiedere	1	10
BT100		D. 100	Richiedere	1	10
BT125		D. 125	Richiedere	1	10
BT140		D. 140	Richiedere	1	10
BT160		D. 160	Richiedere	1	10
BT200		D. 200	Richiedere	1	10

Derivazione Ridotta (braga ridotta) "V" 45°



Codice	SubCodice	Riferimenti	Listino	U.M.	Conf.
BVR100X40		100x40	Richiedere	1	10
BVR100X50		100X50	Richiedere	1	10
BVR100X63		100X63	Richiedere	1	10
BVR100X80		100X80	Richiedere	1	10
BVR125X40		125X40	Richiedere	1	10
BVR125X50		125X50	Richiedere	1	10
BVR125X63		125X63	Richiedere	1	10
BVR125X80		125X80	Richiedere	1	10
BVR125X100		125X100	Richiedere	1	10

Derivazione Ridotta (braga ridotta) "T" 90°

Codice	SubCodice	Riferimenti	Listino	U.M.	Conf.
BVR100X40		100x40	Richiedere	1	10
BVR100X50		100X50	Richiedere	1	10
BVR100X63		100X63	Richiedere	1	10
BVR100X80		100X80	Richiedere	1	10
BVR125X40		125X40	Richiedere	1	10
BVR125X50		125X50	Richiedere	1	10
BVR125X63		125X63	Richiedere	1	10
BVR125X80		125X80	Richiedere	1	10
BVR125X100		125X100	Richiedere	1	10



Riduzione Bicchiere Sul Maggiore

Codice	SubCodice	Riferimenti	Listino	U.M.	Conf.
R40X32		40Fx32M	Richiedere	1	10
R50X40		50Fx40M	Richiedere	1	10
R63X40		63Fx40M	Richiedere	1	10
R80X63		80Fx63M	Richiedere	1	10
R80X40		80Fx40M	Richiedere	1	10
R100X80		100Fx80M	Richiedere	1	10
R100X63		100Fx63M	Richiedere	1	10
R100X40		100Fx40M	Richiedere	1	10
R125X100		125Fx100M	Richiedere	1	10
R140X100		140Fx100M	Richiedere	1	10
R140X125		140Fx125M	Richiedere	1	10
R160X140		160Fx140M	Richiedere	1	10
R200X160		200Fx160M	Richiedere	1	10



Aumento Bicchiere Sul Minore

Codice	SubCodice	Riferimenti	Listino	U.M.	Conf.
A32X40		40Mx32F	Richiedere	1	10
A40X50		50Mx40F	Richiedere	1	10
A40X63		63Mx40F	Richiedere	1	10
A40X80		80Mx40F	Richiedere	1	10
A40X100		100Mx40F	Richiedere	1	10
A63X80		80Mx63F	Richiedere	1	10
A63X100		100Mx63F	Richiedere	1	10
A80X100		100Mx80F	Richiedere	1	10
A100X125		125Mx100F	Richiedere	1	10
A100X140		140Mx100F	Richiedere	1	10
A125X140		140Mx125F	Richiedere	1	10
A140X160		160Mx140F	Richiedere	1	10
A160X200		200Mx160F	Richiedere	1	10



Tampone aumento Bicchere Minore

Codice	SubCodice	Riferimenti	Listino	U.M.	Conf.
T40X32		40x32	Richiedere	1	10
T63X40		63x40	Richiedere	1	10
T80X40		80x40	Richiedere	1	10
T100X40		100x40	Richiedere	1	10
T125X100		125x100	Richiedere	1	10
T125X40		125x40	Richiedere	1	10
T100X32X3		100x32x32	Richiedere	1	10
T100X40X3		100x40x32	Richiedere	1	10
T100X40X4		100x40x40	Richiedere	1	10



Tampone a tre fori da 40

Codice	SubCodice	Riferimenti	Listino	U.M.	Conf.
TA100TF40		100-40-40-40	Richiedere	1	10

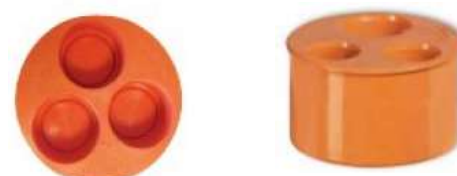



ISPEZIONABILE

SIFONE O-O DA 100 "ZC"

Codice	SubCodice	Riferimenti	Listino	U.M.	Conf.
S00100240		2 usc. 40 predisposti	Richiedere	1	10



SIFONE O-O DA 100 "ZC"

Codice	SubCodice	Riferimenti	Listino	U.M.	Conf.
S00100			Richiedere	1	10
S00125			Richiedere	1	10



SIFONE V-O DA 100 "ZC"

Codice	SubCodice	Riferimenti	Listino	U.M.	Conf.
SVO100			Richiedere	1	10
SVO125			Richiedere	1	10



SIFONE ROMA DA 100 PVC "ZC"

Codice	SubCodice	Riferimenti	Listino	U.M.	Conf.
SR100			Richiedere	1	10
SR80			Richiedere	1	10



SIFONE VV DA 100 MONOLOITICO "ZC"

Codice	SubCodice	Riferimenti	Listino	U.M.	Conf.
SVV100			Richiedere	1	10



SIFONE VERTICALE MARTINO 80 "ZC"

Codice	SubCodice	Riferimenti	Listino	U.M.	Conf.
SVM80			Richiedere	1	10
SVM100			Richiedere	1	10



BOCCHETTONE ANGOLO 100 PVC "ZC"

Codice	SubCodice	Riferimenti	Listino	U.M.	Conf.
BPA100		angolo 100	Richiedere	1	10
BP100		pavimento 100	Richiedere	1	10

Nota bene i pezzi speciali possono essere lavorati artigianalmente con saldature professionali

GIUNTO SCORREVOLE DA 80 "ZC"

Codice	SubCodice	Riferimenti	Listino	U.M.	Conf.
GS80		D. 80	Richiedere	1	10
GS100		D. 100	Richiedere	1	10
GS125		D. 125	Richiedere	1	10

**GIUNTO RIPARAZIONE DA 100 "ZC"**

Codice	SubCodice	Riferimenti	Listino	U.M.	Conf.
GR100		D. 100	Richiedere	1	10
GR125		D. 125	Richiedere	1	10

**Tappo a Vite**

Codice	SubCodice	Riferimenti	Listino	U.M.	Conf.
TV32		D. 32	Richiedere	1	10
TV40		D. 40	Richiedere	1	10
TV50		D. 50	Richiedere	1	10
TV63		D. 63	Richiedere	1	10
TV80		D. 80	Richiedere	1	10
TV100		D. 100	Richiedere	1	10
TV125		D. 125	Richiedere	1	10
TV140		D. 140	Richiedere	1	10
TV160		D. 160	Richiedere	1	10
TV200		D. 200	Richiedere	1	10

**Tappo Fisso**

Codice	SubCodice	Riferimenti	Listino	U.M.	Conf.
TFS32		D. 32	Richiedere	1	10
TFS40		D. 40	Richiedere	1	10
TFS50		D. 50	Richiedere	1	10

**Valvola Antiriflusso**

Codice	SubCodice	Riferimenti	Listino	U.M.	Conf.
VA100		D. 100	Richiedere	1	10
VA125		D. 125	Richiedere	1	10
VA140		D. 140	Richiedere	1	10
VA160		D. 160	Richiedere	1	10
VA200		D. 200	Richiedere	1	10

**Scorrevole con fermo Cod. MFS**

Codice	SubCodice	Riferimenti	Listino	U.M.	Conf.
MFS32			Richiedere	1	10
MFS40			Richiedere	1	10

**Scorrevole senza fermo Cod. MFS**

Codice	SubCodice	Riferimenti	Listino	U.M.	Conf.
MS80		D. 80	Richiedere	1	10
MS100		D. 100	Richiedere	1	10
MS125		D. 125	Richiedere	1	10

**Curva 90° con ispezione in Testa**

Codice	SubCodice	Riferimenti	Listino	U.M.	Conf.
CSTV87100		D. 100	Richiedere	1	10



Nota bene i pezzi speciali possono essere lavorati artigianalmente con saldature professionali

CSTVS



Curva 90° con ispezione SX

Codice	SubCodice	Riferimenti	Listino	U.M.	Conf.
CSTVS87100		D. 100	Richiedere	1	10
CSTVS87125		D. 125	Richiedere	1	10
CSTVS87140		D. 140	Richiedere	1	10
CSTVS87160		D. 160	Richiedere	1	10
CSTVS87200		D. 200	Richiedere	1	10

CSTVD



Curva 90° con ispezione DX

Codice	SubCodice	Riferimenti	Listino	U.M.	Conf.
CSTVD87100		D. 100	Richiedere	1	10
CSTVD87125		D. 125	Richiedere	1	10
CSTVD87140		D. 140	Richiedere	1	10
CSTVD87160		D. 160	Richiedere	1	10
CSTVD87200		D. 200	Richiedere	1	10

CSTVD



Curva 45° con ispezione DX

Codice	SubCodice	Riferimenti	Listino	U.M.	Conf.
CSTVD45100		D. 100	Richiedere	1	10
CSTVD45125		D. 125	Richiedere	1	10
CSTVD45140		D. 140	Richiedere	1	10
CSTVD45160		D. 160	Richiedere	1	10
CSTVD45200		D. 200	Richiedere	1	10

CSTVS



Curva 45° con ispezione SX

Codice	SubCodice	Riferimenti	Listino	U.M.	Conf.
CSTVS45100		D. 100	Richiedere	1	10
CSTVS45125		D. 125	Richiedere	1	10
CSTVS45140		D. 140	Richiedere	1	10
CSTVS45160		D. 160	Richiedere	1	10
CSTVS45200		D. 200	Richiedere	1	10

DSTVD



Derivazione V 45° Con ispezione DX

Codice	SubCodice	Riferimenti	Listino	U.M.	Conf.
DSTVD45100		D. 100	Richiedere	1	10
DSTVD45125		D. 125	Richiedere	1	10

DSTVS



Derivazione V 45° Con ispezione SX

Codice	SubCodice	Riferimenti	Listino	U.M.	Conf.
DSTVS45100		D. 100	Richiedere	1	10
DSTVS45125		D. 125	Richiedere	1	10

DSTVS



Derivazione T 87° 30' Con ispezione DX

Codice	SubCodice	Riferimenti	Listino	U.M.	Conf.
DSTVS87100		D. 100	Richiedere	1	10
DSTVS87125		D. 125	Richiedere	1	10

DSTVD



Derivazione T 87° 30' Con ispezione SX

Codice	SubCodice	Riferimenti	Listino	U.M.	Conf.
DSTVD87100		D. 100	Richiedere	1	10
DSTVD87125		D. 125	Richiedere	1	10



Derivazione T 87° 30' Con tappo ispezione

Codice	SubCodice	Riferimenti	Listino	U.M.	Conf.
DTIS100		D. 100	Richiedere	1	10

Braga doppia a Croce

Codice	SubCodice	Riferimenti	Listino	U.M.	Conf.
BC100		D. 100	Richiedere	1	10

**Braga doppia ad angolo 45°**

Codice	SubCodice	Riferimenti	Listino	U.M.	Conf.
BVD100		D. 100	Richiedere	1	10
BVD125		D. 125	Richiedere	1	10

**Braga doppia scagno ad angolo 45°**

Codice	SubCodice	Riferimenti	Listino	U.M.	Conf.
BVS100		D. 100	Richiedere	1	10
BVS125		D. 125	Richiedere	1	10

**Braga a "V" ridotta 45°**

Codice	SubCodice	Riferimenti	Listino	U.M.	Conf.
BVR100X40		100x40	Richiedere	1	10
BVR100X50		100X50	Richiedere	1	10
BVR100X63		100X63	Richiedere	1	10
BVR100X80		100X80	Richiedere	1	10

**Derivazione ridotta 45° doppia lineare**

Codice	SubCodice	Riferimenti	Listino	U.M.	Conf.
BVR40X100X40		40x100x40	Richiedere	1	10

**Derivazione ridotta 45° doppia stesso lato**

Codice	SubCodice	Riferimenti	Listino	U.M.	Conf.
DR2V10040		100x40x40	Richiedere	1	10

**Derivazione ridotta 45° tripla 1+2 lineare**

Codice	SubCodice	Riferimenti	Listino	U.M.	Conf.
DR3V10040		40X100x40X40	Richiedere	1	10

**Derivazione ridotta 45° Poker 2+2 lineare**

Codice	SubCodice	Riferimenti	Listino	U.M.	Conf.
DR4V10040		40X40X100x40X40	Richiedere	1	10



Nota bene i pezzi speciali possono essere lavorati artigianalmente con saldature professionali



Derivazione Ridotta (brega ridotta) "T" 90°

Codice	SubCodice	Riferimenti	Listino	U.M.	Conf.
BVR100X40		100x40	Richiedere	1	10
BVR100X50		100X50	Richiedere	1	10
BVR100X63		100X63	Richiedere	1	10



Derivazione ridotta 87° doppia stesso lato

Codice	SubCodice	Riferimenti	Listino	U.M.	Conf.
DR2T10040		100x40X40	Richiedere	1	10



Derivazione ridotta 87° tripla stesso lato

Codice	SubCodice	Riferimenti	Listino	U.M.	Conf.
DR3T10040		100x40X40x40	Richiedere	1	10



Derivazione ridotta 87° poker stesso lato

Codice	SubCodice	Riferimenti	Listino	U.M.	Conf.
DR4T10040		100x40X40x40x40	Richiedere	1	10



Derivazione ridotta 87° doppia ad angolo

Codice	SubCodice	Riferimenti	Listino	U.M.	Conf.
DR2TS10040		40x100x40	Richiedere	1	10



Derivazione ridotta 87° poker ad angolo

Codice	SubCodice	Riferimenti	Listino	U.M.	Conf.
DR4TS10040		40x40x100x40x40	Richiedere	1	10



Parafoglie in Plastica "Universale"

Codice	SubCodice	Riferimenti	Listino	U.M.	Conf.
PF60-125		60<>125	Richiedere	1	10

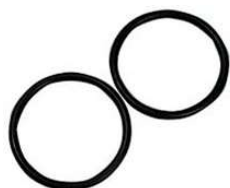

Oring per tappo a vite

Codice	SubCodice	Riferimenti	Listino	U.M.	Conf.
GTV100		D. 100	Richiedere	1	10
GTV125		D. 125	Richiedere	1	10
GTV140		D. 140	Richiedere	1	10

Nota bene i pezzi speciali possono essere lavorati artigianalmente con saldature professionali

Curva wc 87° uscita 100 x 110 wc

Codice	SubCodice	Riferimenti	Listino	U.M.	Conf.
CWC		100X110-WC	Richiedere	1	10

**Curva wc 87° uscita 100 x 110 wc attacco laterale**

Codice	SubCodice	Riferimenti	Listino	U.M.	Conf.
CWC40D		WCx40 Dx	Richiedere	1	10
CWC40S		WCx40 Sx	Richiedere	1	10

sx

**Curva wc 87° uscita 100 x 110 wc attacco laterale**

Codice	SubCodice	Riferimenti	Listino	U.M.	Conf.
CWC2L40		WCx40 Laterale	Richiedere	1	10

**Curva wc 87° uscita 100 x 110 wc attacco laterale**

Codice	SubCodice	Riferimenti	Listino	U.M.	Conf.
CWC3L40		WCx40 Laterale	€ 6,75	1	10

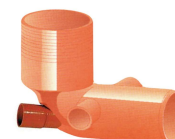
**Colla per tubi arancio Riempitivo**

Codice	SubCodice	Riferimenti	Listino	U.M.	Conf.
TCRP		gr. 125	Richiedere	1	100
BCRP		gr. 500	Richiedere	1	24
BCRP700		gr. 700	Richiedere	1	24

**Colla per tubi arancio Universale**

Codice	SubCodice	Riferimenti	Listino	U.M.	Conf.
TCVC		gr. 125	Richiedere	1	100
BCVC		gr. 500	Richiedere	1	24
BCVC1		gr. 1000	Richiedere	1	12

**Colla per tubi Trasparente Alta Resa**

Codice	SubCodice	Riferimenti	Listino	U.M.	Conf.
TTCF		gr. 125	Richiedere	1	12

**Scivolante in gel per tubi PVC**

Codice	SubCodice	Riferimenti	Listino	U.M.	Conf.
S150		gr. 250	Richiedere	1	10
S250			Richiedere	1	10

**Curva Aperta 45° Redi**

Codice	SubCodice	Riferimenti	Listino	U.M.	Conf.
CA32R		D. 32 redi	Richiedere	1	50
CA40R		D. 40 redi	Richiedere	1	50
CA50R		D. 50 redi	Richiedere	1	50

REDI
LE STRADE DELL'ACQUA
Curva Chiusa 90° Redi

Codice	SubCodice	Riferimenti	Listino	U.M.	Conf.
CC32R		D. 32 redi	Richiedere	1	50
CC40R		D. 40 redi	Richiedere	1	50
CC50R		D. 50 redi	Richiedere	1	50

REDI
LE STRADE DELL'ACQUA

Nota bene i pezzi speciali possono essere lavorati artigianalmente con saldature professionali



Tubo in Pvc 1 mt

Codice	SubCodice	Riferimenti	Listino	U.M.	Conf.
T32X1		32x1	Richiedere	1	10
T40X1		40x1	Richiedere	1	10
T50X1		50x1	Richiedere	1	10
T63X1		63x1	Richiedere	1	10
T80X1		80x1	Richiedere	1	10
T100X1		100x1	Richiedere	1	10
T125X1		125x1	Richiedere	1	10
T140X1		140x1	Richiedere	1	10
T160X1		160x1	Richiedere	1	10
T200X1		200x1	Richiedere	1	10



Tubo in Pvc 2 mt

Codice	SubCodice	Riferimenti	Listino	U.M.	Conf.
T32X2		32x2	Richiedere	1	10
T40X2		40x2	Richiedere	1	10
T50X2		50x2	Richiedere	1	10
T63X2		63x2	Richiedere	1	10
T80X2		80x2	Richiedere	1	10
T100X2		100x2	Richiedere	1	10
T125X2		125x2	Richiedere	1	10
T140X2		140x2	Richiedere	1	10
T160X2		160x2	Richiedere	1	10
T200X2		200x2	Richiedere	1	10



Tubo in Pvc 3 mt

Codice	SubCodice	Riferimenti	Listino	U.M.	Conf.
T32X3		32x3	Richiedere	1	10
T40X3		40x3	Richiedere	1	10
T50X3		50x3	Richiedere	1	10
T63X3		63x3	Richiedere	1	10
T80X3		80x3	Richiedere	1	10
T100X3		100x3	Richiedere	1	10
T125X3		125x3	Richiedere	1	10
T140X3		140x3	Richiedere	1	10
T160X3		160x3	Richiedere	1	10
T200X3		200x3	Richiedere	1	10



Collare leggero per pluviale

Codice	SubCodice	Riferimenti	Listino	U.M.	Conf.
CL32		D. 32	Richiedere	1	10
CL40		D. 40	Richiedere	1	10
CL50		D. 50	Richiedere	1	10
CL60		D. 63	Richiedere	1	10
CL80		D. 80	Richiedere	1	10
CL100		D. 100	Richiedere	1	10
CL125		D. 125	Richiedere	1	10
CL140		D. 140	Richiedere	1	10
CL160		D. 160	Richiedere	1	10
CL200		D. 200	Richiedere	1	10



CURVA TECNICA RIDOTTA PVC ARANCIO 87°30' MF

Codice	SubCodice	Riferimenti	Listino	U.M.	Conf.
CR40X32MF		D. 40X32	Richiedere	1	10
CR50X40MF		D. 50X40	Richiedere	1	10



Tubo in PP 1 Bicchiere



Codice	SubCodice	Riferimenti	Mis.	Listino	U.M.	Conf.
VS0501005		HTEM 1 BICCHERE MT. 50	D. 32	Richiedere	1	10
VS0501009		HTEM 1 BICCHERE MT. 1,00	D. 32	Richiedere	1	10
VS0501013		HTEM 1 BICCHERE MT. 2,00	D. 32	Richiedere	1	10
VS0501015		HTEM 1 BICCHERE MT. 3,00	D. 32	Richiedere	1	10
VS0501025		HTEM 1 BICCHERE MT. 50	D. 40	Richiedere	1	10
VS0501029		HTEM 1 BICCHERE MT. 1,00	D. 40	Richiedere	1	10
VS0501033		HTEM 1 BICCHERE MT. 2,00	D. 40	Richiedere	1	10
VS0501035		HTEM 1 BICCHERE MT. 3,00	D. 40	Richiedere	1	10
VS0501045		HTEM 1 BICCHERE MT. 50	D. 50	Richiedere	1	10
VS0501049		HTEM 1 BICCHERE MT. 1,00	D. 50	Richiedere	1	10
VS0501053		HTEM 1 BICCHERE MT. 2,00	D. 50	Richiedere	1	10
VS0501055		HTEM 1 BICCHERE MT. 3,00	D. 50	Richiedere	1	10
VS0501145		HTEM 1 BICCHERE MT. 50	D. 90	Richiedere	1	10
VS0501149		HTEM 1 BICCHERE MT. 1,00	D. 90	Richiedere	1	10
VS0501153		HTEM 1 BICCHERE MT. 2,00	D. 90	Richiedere	1	10
VS0501155		HTEM 1 BICCHERE MT. 3,00	D. 90	Richiedere	1	10
VS0501085		HTEM 1 BICCHERE MT. 50	D. 110	Richiedere	1	10
VS0501089		HTEM 1 BICCHERE MT. 1,00	D. 110	Richiedere	1	10
VS0501093		HTEM 1 BICCHERE MT. 2,00	D. 110	Richiedere	1	10
VS0501095		HTEM 1 BICCHERE MT. 3,00	D. 110	Richiedere	1	10
VS0501125		HTEM 1 BICCHERE MT. 50	D. 160	Richiedere	1	10
VS0501129		HTEM 1 BICCHERE MT. 1,00	D. 160	Richiedere	1	10
VS0501133		HTEM 1 BICCHERE MT. 2,00	D. 160	Richiedere	1	10
VS0501135		HTEM 1 BICCHERE MT. 3,00	D. 160	Richiedere	1	10

Tubo in PP 2 Bicchiere



Codice	SubCodice	Riferimenti	Mis.	Listino	U.M.	Conf.
VS0501201		HTEM 2 BICCHERE MT. 50	D. 32	Richiedere	1	10
VS0501203		HTEM 2 BICCHERE MT. 1,00	D. 32	Richiedere	1	10
VS0501205		HTEM 2 BICCHERE MT. 2,00	D. 32	Richiedere	1	10
VS0501207		HTEM 2 BICCHERE MT. 3,00	D. 32	Richiedere	1	10
VS0501213		HTEM 2 BICCHERE MT. 50	D. 40	Richiedere	1	10
VS0501215		HTEM 2 BICCHERE MT. 1,00	D. 40	Richiedere	1	10
VS0501217		HTEM 2 BICCHERE MT. 2,00	D. 40	Richiedere	1	10
VS0501219		HTEM 2 BICCHERE MT. 3,00	D. 40	Richiedere	1	10
VS0501225		HTEM 2 BICCHERE MT. 50	D. 50	Richiedere	1	10
VS0501227		HTEM 2 BICCHERE MT. 1,00	D. 50	Richiedere	1	10
VS0501229		HTEM 2 BICCHERE MT. 2,00	D. 50	Richiedere	1	10
VS0501231		HTEM 2 BICCHERE MT. 3,00	D. 50	Richiedere	1	10
VS0501281		HTEM 2 BICCHERE MT. 50	D. 90	Richiedere	1	10
VS0501283		HTEM 2 BICCHERE MT. 1,00	D. 90	Richiedere	1	10
VS0501285		HTEM 2 BICCHERE MT. 2,00	D. 90	Richiedere	1	10
VS0501287		HTEM 2 BICCHERE MT. 3,00	D. 90	Richiedere	1	10
VS0501249		HTEM 2 BICCHERE MT. 50	D. 110	Richiedere	1	10
VS0501251		HTEM 2 BICCHERE MT. 1,00	D. 110	Richiedere	1	10
VS0501253		HTEM 2 BICCHERE MT. 2,00	D. 110	Richiedere	1	10
VS0501255		HTEM 2 BICCHERE MT. 3,00	D. 110	Richiedere	1	10

Braga Semplice a 45° in PP

Codice	SubCodice	Riferimenti	Mis.	Listino	U.M.	Conf.
VS0508001		BRAGA 45°	D. 32	Richiedere	1	10
VS0508007		BRAGA 45°	D. 40	Richiedere	1	10
VS0508013		BRAGA 45°	D. 50	Richiedere	1	10
VS0599061		BRAGA 45°	D. 90	Richiedere	1	10
VS0508025		BRAGA 45°	D. 110	Richiedere	1	10
VS0508037		BRAGA 45°	D. 160	Richiedere	1	10



Braga Semplice a 90° in PP

Codice	SubCodice	Riferimenti	Mis.	Listino	U.M.	Conf.
VS0508005		BRAGA 87° 30'	D. 32	Richiedere	1	10
VS0508011		BRAGA 87° 30'	D. 40	Richiedere	1	10
VS0508017		BRAGA 87° 30'	D. 50	Richiedere	1	10
VS0599065		BRAGA 87° 30'	D. 90	Richiedere	1	10
VS0508029		BRAGA 87° 30'	D. 110	Richiedere	1	10
VS5008041		BRAGA 87° 30'	D. 160	Richiedere	1	10



Curva MF a 90° in PP

Codice	SubCodice	Riferimenti	Mis.	Listino	U.M.	Conf.
VS0504011		CURVA 87° 30'	D. 32	Richiedere	1	10
VS0504023		CURVA 87° 30'	D. 40	Richiedere	1	10
VS0504035		CURVA 87° 30'	D. 50	Richiedere	1	10
VS0599051		CURVA 87° 30'	D. 90	Richiedere	1	10
VS0504059		CURVA 87° 30'	D. 110	Richiedere	1	10
VS0504083		CURVA 87° 30'	D. 160	Richiedere	1	10



Curva MF a 45° in PP

Codice	SubCodice	Riferimenti	Mis.	Listino	U.M.	Conf.
VS0504005		CURVA 45°	D. 32	Richiedere	1	10
VS0504017		CURVA 45°	D. 40	Richiedere	1	10
VS0504029		CURVA 45°	D. 50	Richiedere	1	10
VS0599045		CURVA 45°	D. 90	Richiedere	1	10
VS0504053		CURVA 45°	D. 110	Richiedere	1	10
VS0504065		CURVA 45°	D. 125	Richiedere	1	10
VS0504077		CURVA 45°	D. 160	Richiedere	1	10



HTRE ISPEZIONE CON TAPPO

Codice	SubCodice	Riferimenti	Mis.	Listino	U.M.	Conf.
VS0516007			D. 110	Richiedere	1	10



Aumento a Tappo in PP

Codice	SubCodice	Riferimenti	Mis.	Listino	U.M.	Conf.
RDEC53		32-50		Richiedere	1	10
RDEC14C		40-110		Richiedere	1	10



SIFONE FIRENZE

Codice	SubCodice	Riferimenti	Mis.	Listino	U.M.	Conf.
VS0533110		SIFONE FIRENZE	D. 110	Richiedere	1	10





TRONCHETTO COLLEGAMENTO

Codice	SubCodice	Riferimenti	Mis.	Listino	U.M.	Conf.
VS0564121		D. 40/40		Richiedere	1	10
VS0564123		D. 50/50		Richiedere	1	10
VS0564190		D. 90/100		Richiedere	1	10
VS0564101		D. 110/110		Richiedere	1	10



TAPPO DI CHIUSURA

Codice	SubCodice	Riferimenti	Mis.	Listino	U.M.	Conf.
VS0524001		D. 40		Richiedere	1	10
VS0524003		D. 50		Richiedere	1	10
VS0599141		D. 90		Richiedere	1	10
VS024007		D. 110		Richiedere	1	10



Manicotto FF in PP

Codice	SubCodice	Riferimenti	Mis.	Listino	U.M.	Conf.
VS0528000		Manicotto FF	D. 32	Richiedere	1	10
VS0528001		Manicotto FF	D. 40	Richiedere	1	10
VS0528003		Manicotto FF	D. 50	Richiedere	1	10
VS0599111		Manicotto FF	D. 90	Richiedere	1	10
VS0528007		Manicotto FF	D. 110	Richiedere	1	10
VS0528011		Manicotto FF	D. 160	Richiedere	1	10



Bicchere Aumento in PP

Codice	SubCodice	Riferimenti	Listino	U.M.	Conf.
VS0514001		HTR AUMENTI ECCENTRICID. 40-32	Richiedere	1	10
VS0514002		HTR AUMENTI ECCENTRICID. 50-32	Richiedere	1	10
VS0514003		HTR AUMENTI ECCENTRICID. 50-40	Richiedere	1	10
VS0513001		Bicchere Aumento D. 50-40	Richiedere	1	10
VS0599131		HTR AUMENTI ECCENTRICID. 90-40	Richiedere	1	10
VS0599133		HTR AUMENTI ECCENTRICID. 90/50	Richiedere	1	10
VS0514008		HTR AUMENTI ECCENTRICID. 110-40	Richiedere	1	10
VS0514009		HTR AUMENTI ECCENTRICID. 110-50	Richiedere	1	10
RDEC19		HTR AUMENTI ECCENTRICID. 110-90	Richiedere	1	10
VS0514015		HTR AUMENTI ECCENTRICID. 125/110	Richiedere	1	10



HTEA braga ridotta 45°

Codice	SubCodice	Riferimenti	Mis.	Listino	U.M.	Conf.
VS0510001		D.40/32		Richiedere	1	10
VS0599071		D.90/40		Richiedere	1	10
VS0599073		D.90/50		Richiedere	1	10
VS0510025		D.110/40		Richiedere	1	10
VS0599089		D.110/90		Richiedere	1	10
VS0510031		D.110/50		Richiedere	1	10
VS0510061		D.160/110		Richiedere	1	10



Braga ridotta 87° 30''

Codice	SubCodice	Riferimenti	Mis.	Listino	U.M.	Conf.
VS0599075		D.90/40		Richiedere	1	10
VS0599077		D.90/50		Richiedere	1	10
VS0510029		D.110/40		Richiedere	1	10
VS0510035		D.110/50		Richiedere	1	10
VS0510065		D.160/110		Richiedere	1	10

Tronchetto per collegamento Pvc

Codice	SubCodice	Riferimenti	Mis.	Listino	U.M.	Conf.
VS0530001		D.40		Richiedere	1	10
VS0530003		D.50		Richiedere	1	10
VS0599121		D.90		Richiedere	1	10
VS0530007		D.110		Richiedere	1	10



Tronchetto per collegamento Pvc

Codice	SubCodice	Riferimenti	Mis.	Listino	U.M.	Conf.
VS0530001		D.40		Richiedere	1	10
VS0530003		D.50		Richiedere	1	10
VS0599121		D.90		Richiedere	1	10
VS0530007		D.110		Richiedere	1	10



HTSW curva tecnica completa, senza morsetto con tappo

Codice	SubCodice	Riferimenti	Mis.	Listino	U.M.	Conf.
VS0518113		D.40		Richiedere	1	10
VS0518117		D.50		Richiedere	1	10
VS051807		D.40/46		Richiedere	1	10



AUMENTO CONCENTRICO 90/110

Codice	SubCodice	Riferimenti	Mis.	Listino	U.M.	Conf.
VS0599161		D.90/110		Richiedere	1	10

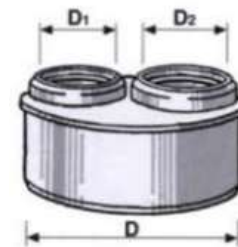

RACCORDO WC PP HTSK D.110X230"ZC"

Codice	SubCodice	Riferimenti	Mis.	Listino	U.M.	Conf.
VS0536001		D.110		Richiedere	1	10



RACCORDO SELLA

Codice	SubCodice	Riferimenti	Mis.	Listino	U.M.	Conf.
SL104		100X40		Richiedere	1	10
SL124		125X40		Richiedere	1	10

Sella



Curve Tecniche ad incollaggio

Codice	SubCodice	Riferimenti	Mis.	Listino	U.M.	Conf.
CR40X32FF		D. 40 F x 32 F		Richiedere	1	10
CR40X32FM		D. 40 F x 32 M		Richiedere	1	10
C40FF		D. 40 F x 40 F		Richiedere	1	10



DESCRIZIONE

Il cavidotto corrugato è un tubo in polietilene particolarmente adatto alla protezione dei cavi nelle installazioni elettriche e di telecomunicazione interrate.

CARATTERISTICHE CAVIDOTTO CORRUGATO

Il cavidotto a doppia parete CORRUGAR è costituito da due tubolari coestrusi e sagomati in modo che la parete interna, in polietilene bassa densità, resti continua e liscia, mentre quella esterna, in polietilene alta densità, assuma la tipica corrugazione necessaria a conferire al manufatto un'adeguata resistenza strutturale.

L'estrema cura dell'imballo consente un agevole stoccaggio in magazzino grazie ad un razionale packaging che rende le matasse facilmente impilabili; una particolare additivazione garantisce per 18 mesi lo stoccaggio anche a cielo aperto.

MATERIALI CAVIDOTTO CORRUGATO A DOPPIA PARETE

Sia la parte esterna sia quella interna sono realizzate con materiali di prima scelta non rigenerati, garanzia di qualità e lunga durata del manufatto. Inoltre, la qualità delle materie prime selezionate per la fabbricazione assicura l'assenza di memoria plastica nel cavidotto facilitando la posa in trincea.

Il prodotto abbina doti di estrema leggerezza e flessibilità assieme ad una resistenza allo schiacciamento di valore tale da poter essere utilizzato senza particolari precauzioni di posa in opera.

Tubo corrugato in HDPE Cavidotto

Codice	Riferimenti	Listino	U.M.	Conf.
CAV40	D. 40X31	Richiedere	1	50
CAV50	D. 50X40	Richiedere	1	50
CAV63	D. 63X50	Richiedere	1	50
CAV75	D. 75X60	Richiedere	1	50
CAV90	D. 90X73	Richiedere	1	50
CAV110	D. 110X92	Richiedere	1	50
CAV125	D. 125X105	Richiedere	1	50
CAV140	D. 140X120	Richiedere	1	50
CAV160	D. 160X137	Richiedere	1	50
CAV200	D. 200X171	Richiedere	1	50



TUBO CORRUGATO NERO

Sistemi di tubazioni di materia plastica per connessioni di scarico e collettori di fognatura interrati non in pressione:

Sistemi di tubazioni a parete strutturata di PVC-U, PP e PE Superficie interna liscia e superficie esterna profilata (UNI EN 13476-3)

Classe di rigidità anulare (SN): SN 4 - 8 KPa (tubi in PE)

Tubi in barre da mt. 6 - Bicchiere e guarnizione.

SISTEMA DI GIUNZIONE PER TUBI / Joint system profile for pipes / Système de jonction pour tubes

DN/OD ≤ 1000 E DN/ID ≤ 600

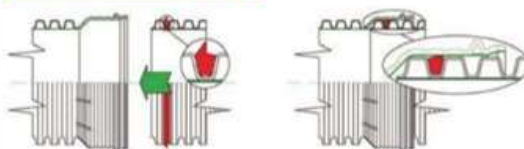

PROFILO COSTOLA PER
Outside layer profile for
Profil pari anneau pour
STANDARD DN/OD

PROFILO COSTOLA
Outside layer profile for
Profil pari anneau pour
STANDARD DN/ID

Tubo corrugato in HDPE Drenaggio

Codice	Riferimenti	Listino	U.M.	Conf.
DREN63	D. 63X50	Richiedere	1	50
DREN75	D. 75X60	Richiedere	1	50
DREN90	D. 90X73	Richiedere	1	50
DREN110	D. 110X92	Richiedere	1	50
DREN125	D. 125X105	Richiedere	1	50
DREN140	D. 140X120	Richiedere	1	50
DREN160	D. 160X137	Richiedere	1	50
DREN200	D. 200X171	Richiedere	1	50





TELAIO + GRIGLIA

Codice	Riferimenti	Listino
UTG20PP	200X200	Richiedere
UTG30PP	300X300	Richiedere
UTG40PP	400X400	Richiedere
UTG55PP	550X550	Richiedere

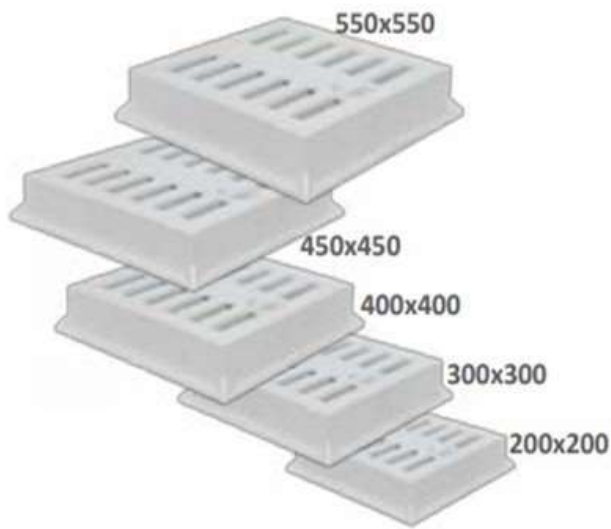

CHIUSINO SIFONATO

Codice	Riferimenti	Listino
CS10PP	10X10	Richiedere
CS15PP	15X15	Richiedere



Chiusino 10x10 Sifonato Usc. 40

Codice	Riferimenti	Listino
CHABS1040G	Grigio	Richiedere
CHABS1040M	Cromo	Richiedere

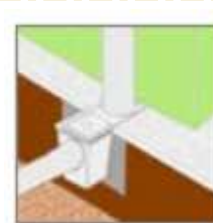

Pozzetto pluviale universale usc. tonde 80-82-90-100-110

Codice	Riferimenti	Listino
PPU	Grigio	Richiedere

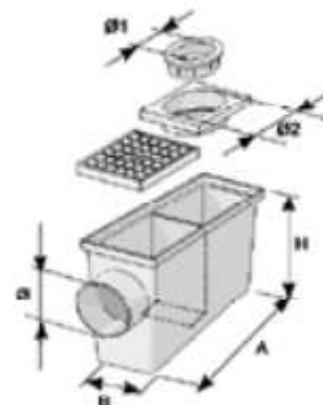

POZZETTO & COPERCHIO

Codice	Riferimenti	Listino
PUC20PP	200X200	Richiedere
PUC30PP	300X300	Richiedere
PUC40PP	400X400	Richiedere
PUC55PP	550X550	Richiedere



TELAIO + COPERCHIO

Codice	Riferimenti	Listino
UTC20PP	200X200	Richiedere
UTC30PP	300X300	Richiedere
UTC40PP	400X400	Richiedere
UTC55PP	550X550	Richiedere

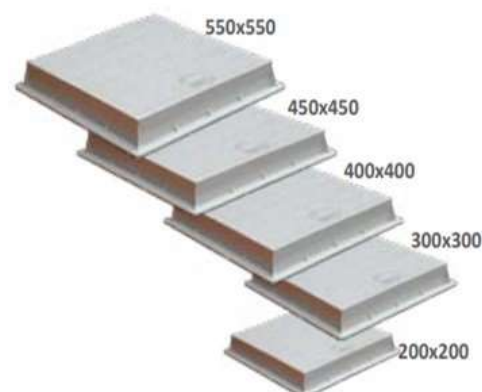



Hydro.SatTM

L'IDRAULICA LA NOSTRA PASSIONE

www.csrconi.com

