

PROFESSIONALITA' E QUALITA'



**EVOKlima**<sup>TM</sup>

TECNOLOGIA - BENESSERE - RISPETTO PER L'AMBIENTE

Edizione

**6°**

04/05/2024

[www.evoklima.it](http://www.evoklima.it)

Smart Ingress

**Ingresso intelligente**



WATER IS LIFE - L'ACQUA È VITA

L'IDRAULICA LA NOSTRA PASSIONE - HYDRAULICS OUR PASSION

# Deposito - EvoKlima



Scarica il foglio  
Excel  
Commissione

## Sala Meeting - Uffici



La nostra crescita si fonda sul rispetto e la fiducia di tutti i nostri collaboratori che danno ogni giorno un grande valore al nostro lavoro.



Tutto il nostro personale è attento a gestire in poco tempo i vostri ordini con precisione e puntualità.

Il servizio di consegna è svolto da mezzi propri in maniera tempestiva e affidabile.

## CONSEGNE IN 24/48 H

Novità cataloghi scaricabili QR. Con il nuovo sistema scaricabile Qr la Evoklima, potrà tenervi aggiornati quotidianamente. Scaricando il Pdf di vostro interesse avrete la possibilità di vedere tutti i prodotti della categoria e sottocategoria, la disponibilità, la merce in arrivo, il prezzo sarà da scontare (secondo le indicazioni fornite dal nostro Staff). Scaricatelo ogni qualvolta vi occorre della merce in modo di avere il pdf sempre aggiornato. il nostro staff avrà cura di tenere i pdf aggiornati.

**N.B. Anche se vedete la disponibilità o merce in arrivo, richiedere la conferma dell'ordine per bloccare gli articoli di interesse. comprenderete essendo un sistema offline potrebbero arrivare più richieste contemporaneamente**



# Smart Ingress

# Brand

# EVOKlima™

 	 	 	 	 	 	   armacell engineered foams
 ARTIPLASTIC LAVORAZIONE MATERIE PLASTICHE	 Bandini WATER HEATERS	 BAMPI	 BAXI	 BATAVIA TODAY TO BUILD	 Bestway	 BIANCHI ANGELO & OSVALDO  bimar
 astori	 Bänninger Conex	 calpeda	 cewal	 DAIKIN	 DIBox	 JUNKERS BOSCH  bonomini TECNOLOGIE IDRALICHE  CAMPINGAZ  CR  de pala  DIAMOND HOME
 elica idee in evoluzione	 elica aria nuova	 FERRARI Tradizione Italiana in Cucina	 gebo FITS BETTER!	 gimi	 GIO'STYLE	 elbi  FABER SINCE 1872  FERRABOLI  Geferplast  Girmi  GIURGOLA SERBATOI  GROHE
 Hotpoint ARISTON	 Hydro.Sat AUTOCLAVE Box Doccia COPRIWATER	 Hydro.Sat Contatori Galleggianti Raccordi	 Hydro.Sat Rubinetti Valvole	 ICMA	 idral  IDRO Bric  IMMERSAS  INTEX	
 LOWARA  LUISE	 rubinetterie  Metal f.a.r. il relax creativo	 METAFORM	 MITSUBISHI ELECTRIC  men Rubinetterie International	 OLIMPIA SPLENDID	 OMAC	 ORBIS energia intelligente
 PlasticForte	 LIT/PROGARDEN	 CASSETTE PUCCI stile e tecnologia italiani	 PENTALUX alluminio professionale	 REDI	 SAB  sendo AIR-CONDITIONING  sime	 SIMBL  sira RADIATORI
 smavit	 SPHERA DOCCE & ACCESSORI	 Stabile	 stefanplast	 Tecnogas	 turboair  Vaillant	 Whirlpool

Abbigliamento



Articoli Estivi Mare & Giardino



Barbecue-Campeggio



Cappe



Casalinghi



Elettrodomestici Libera Installazione



Elettrodomestici Incasso



Ferramenta



Forni a Legna



Giocattoli



Igienizzanti Dispenser



Elettricità



Lavanderia



Lavelli ed Accessori



Mobili Bagno



Olio



Piccoli Elettrodomestici



Piccoli Elettrodomestici Cottura



Piccoli Elettrodomestici Aspirazione



Piccoli Elettrodomestici Riscaldamento



Piccoli Elettrodomestici Ventilazione





Accessori Bagno



Accessori Climatizzatori



Accessori Riscaldamento



Accessori Stufe



Antincendio



Attacco Ferro



Bollitori - Volani Termici



Box Doccia



Caldaie



Canalina



Cassetta Wc



Cavidotto



Climatizzatori - Trattamento Aria



Collettori



Comunità - Terza Età



Contatori Acqua



Docce & Saliscendi



Elettrovalvole



Fancoil-Venticonvettori



Flessibili & antivibranti



Fumisteria



Geferplast S.r.l.



Gallegianti



Gas



Grohe



Guarnizioni



Lavatrice



Maniglioni



Meccanismi Cassetta



Minuterie Idrauliche



Polipropilene



Politilene



Polmoni Autoclave



Pompe



Pucciplast



Pvc



Raccordi Or



Raccordi Bicono



Raccordi Rame-Multistrato



Raccordi Multistrato Bloccare



Raccordi Multistrato Pressare



Raccordi Multistrato Pressare Gas



Raccordi ottone Cromato





Raccordi ottone Giallo



Raccordi Polietilene



Raccordi Polietilene Anello Ottone



Raccordi Polietilene Toff



Raccordi Polietilene-Plastica



Raccordi Quick



Raccordi Rame Pinzare

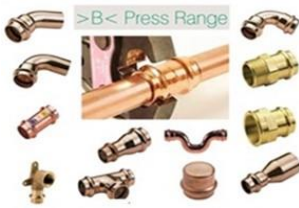

Raccordi Rame Pinzare Gas



Raccordi Zincati



Raccordi Valvole Inox



Radiatori



Rame Climatizzazione



Rame & Isolanti



Ricambi Rubinetti



Rosacce



Rubinetti Giardino



Rubinetti Bagno



Rubinetti Cucina



Rubinetti Sensore



Rubinetti Orinatori & Accessori



Rubinetti a Pedale



Rubinetti Singoli - Passo Rapido



Rubinetti tecnici



Rubinetti Temporizzati - Termostatici



Scaldabagni Elettrici & Accessori



Sanitari



Scaldabagni Gas



Scaldabagni Pompa di Calore



Sedili Copriwater



Serbatoi



Sfere & Accessori Autoclave



Sifoni



Solare



Sportelli - Box Acqua & Gas



Stufe a Gas



Stufe a Pellet



Tattamento Acqua



Tattamento Aria



Tubi Multistrato



Tubi & Raccordi PP



Tubi Zincati



Valvole





La Evoklima vi presenta il nuovo catalogo con Pdf interattivo. Potete scaricarlo dal sito [www.evoklima.it](http://www.evoklima.it) oppure dalla piattaforma B2B [www.edrcsr.it](http://www.edrcsr.it). Scaricate il catalogo in pdf frequentemente per non perdere gli aggiornamenti. Dalla Pag. 02 alla 06 troverete tutte le categorie tramite il codice Qr o semplicemente cliccando nell'immagine potrete ottenere il pdf della categoria con disponibilità e prezzo. Mentre in moltissimi articoli sempre cliccando nell'immagine potrete scaricare le schede tecniche dell'articolo di interesse, Rapido, Veloce "Smart Ingross"

<b>Tubi &amp; Raccordi</b> Pag 10 	<b>Pozzetti</b> Pag 12 	<b>Tubi &amp; Raccordi PP</b> Pag 13 	<b>Politilene</b> Pag 15 
<b>Politilene</b> Pag 16 	<b>Polipropilene</b> Pag 17 	<b>Raccordi Ottone</b> Pag 19 	<b>Valvole</b> Pag 21 
<b>Raccordi Ottone</b> Pag 22 	<b>Tube Multistrato</b> Pag 25 	<b>Raccordi Multistrato</b> Pag 26 Pag 28 	
<b>Tubi &amp; Raccordi Zincati</b> Pag 29 	<b>Gas</b> Pag 31 	<b>Elettropompe &amp; Accessori</b> Pag 34 Pag 40 	
<b>Rubinetti</b> Pag 41 Pag 53 		<b>Minuterie Idrauliche</b> Pag 54 Pag 57 	
<b>Docce-Saliscendi &amp; Accessori Bagno</b> Pag 58 Pag 62 		<b>Comunità</b> Pag 63 Pag 65 	
<b>Sifoni &amp; Accessori</b> Pag 72 Pag 76 		<b>Copriwater &amp; Ricambi</b> Pag 66 Pag 71 	
<b>Accessori Clima</b> Pag 94 Pag 97 		<b>Cassette Wc</b> Pag 83 Pag 93 	
<b>Barbecue</b> Pag 109 Pag 110 		<b>Scaldabagni &amp; accessori</b> Pag 103 Pag 104 	
<b>Elettrodomestici</b> Pag 124 Pag 		<b>Ferramenta &amp; Attrezzi</b> Pag 105 Pag 108 	
<b>Box Doccia</b> Pag 125 Pag 126 		<b>Mobili Bagno</b> Pag 117 Pag 118 	
		<b>Lavanderia</b> Pag 119 Pag 123 	
		<b>Sanitari</b> Pag 127 Pag 128 	
		<b>Piatti Doccia</b> Pag 129 Pag 130 	

PVC tubi & raccordi

PROMO



Tubo 1 mt			D.	Tubo 2 mt			D.	Tubo 3 mt			D.
Codice	Riferimenti	Prezzo		Codice	Riferimenti	Prezzo		Codice	Riferimenti	Prezzo	
T32X1	32x1	2,09 €	576	T32X2	32x2	3,95 €	325	T32X3	32x3	5,53 €	436
T40X1	40x1	2,65 €	1236	T40X2	40x2	5,04 €	556	T40X3	40x3	7,06 €	1474
T50X1	50x1	3,37 €	312	T50X2	50x2	6,41 €	400	T50X3	50x3	8,97 €	327
T63X1	63x1	4,35 €	225	T63X2	63x2	8,37 €	349	T63X3	63x3	11,01 €	176
T80X1	80x1	4,11 €	161	T80X2	80x2	7,81 €	258	T80X3	80x3	10,99 €	487
T100X1	100x1	5,14 €	20	T100X2	100x2	9,81 €	233	T100X3	100x3	13,80 €	160
T125X1	125x1	6,48 €	214	T125X2	125x2	12,36 €	225	T125X3	125x3	17,36 €	65
T140X1	140x1	7,60 €	139	T140X2	140x2	14,55 €	132	T140X3	140x3	20,42 €	80
T160X1	160x1	9,29 €	99	T160X2	160x2	17,80 €	26	T160X3	160x3	25,63 €	68
T200X1	200x1	14,62 €	67	T200X2	200x2	27,98 €	48	T200X3	200x3	40,32 €	41



Curva Chiusa solo a Confezione			D.	Curva Aperta solo a Confezione			D.	Braga a "V" solo a Confezione			D.
Codice	Riferimenti	Prezzo		Codice	Riferimenti	Prezzo		Codice	Riferimenti	Prezzo	
CC32	D. 32	0,53 €	1369	CA32	D. 32	0,44 €	1542	BV32	D. 32	0,80 €	303
CC40	D. 40	0,62 €	435	CA40	D. 40	0,53 €	678	BV40	D. 40	0,89 €	157
CC50	D. 50	0,89 €	2446	CA50	D. 50	0,80 €	1102	BV50	D. 50	1,16 €	244
CC63	D. 63	1,33 €	266	CA63	D. 63	1,25 €	273	BV63	D. 63	2,22 €	1075
CC80	D. 80	1,69 €	90	CA80	D. 80	1,51 €	89	BV80	D. 80	3,20 €	393
CC100	D. 100	1,96 €	1211	CA100	D. 100	1,69 €	1090	BV100	D. 100	3,56 €	930
CC125	D. 125	3,11 €	332	CA125	D. 125	2,67 €	399	BV125	D. 125	6,23 €	97
CC140	D. 140	4,89 €	88	CA140	D. 140	4,00 €	73	BV140	D. 140	8,45 €	34
CC160	D. 160	5,78 €	63	CA160	D. 160	5,34 €	78	BV160	D. 160	10,67 €	14
CC200	D. 200	10,67 €	14	CA200	D. 200	8,89 €	20	BV200	D. 200	21,34 €	24



Tappo Cieco			D.	Tappo con tre fori			D.	Sifone a Colonna			D.
Codice	Riferimenti	Prezzo		Codice	Riferimenti	Prezzo		Codice	Riferimenti	Prezzo	
TFS32	D. 32	0,56 €	0	TA100TF40	100-40-40-40	3,54 €	687	SVM80	D. 80	18,72 €	10
TFS40	D. 40	0,27 €	365					SVM100	D. 100	22,72 €	10
TFS50	D. 50	0,36 €	425					SVM125	D. 125	31,63 €	10





Braga a "T" Ridotta

Braga a "V" Ridotta

Braga a "T" solo a Confezione

Codice	Riferimenti	Prezzo
BTR100X40	100x40	3,11 €
BTR100X50	100X50	3,11 €
BTR100X63	100X63	3,11 €
BTR100X80	100X80	3,11 €
BTR125X40	125X40	7,11 €
BTR125X50	125X50	7,11 €
BTR125X63	125X63	7,11 €
BTR125X80	125X80	7,11 €
BTR125X100	125X100	7,11 €

D.	Codice	Riferimenti	Prezzo
101	BVR100X40	100x40	3,11 €
231	BVR100X50	100X50	3,11 €
0	BVR100X63	100X63	3,11 €
0	BVR100X80	100X80	3,11 €
0	BVR125X40	125X40	7,11 €
0	BVR125X50	125X50	7,11 €
0	BVR125X63	125X63	7,11 €
0	BVR125X80	125X80	7,11 €
0	BVR125X100	125X100	7,11 €

D.	Codice	Riferimenti	Prezzo	D.
189	BT32	D. 32	0,80 €	202
354	BT40	D. 40	0,89 €	516
0	BT50	D. 50	1,16 €	379
0	BT63	D. 63	2,22 €	290
0	BT80	D. 80	3,20 €	304
0	BT100	D. 100	3,56 €	192
0	BT125	D. 125	6,23 €	226
0	BT140	D. 140	8,45 €	40
0	BT160	D. 160	10,67 €	25
0	BT200	D. 200	21,34 €	27



Riduzione FM

Aumento MF

Tappo a Vite

Codice	Riferimenti	Prezzo
R40X32	40Fx32M	0,53 €
R50X40	50Fx40M	0,71 €
R63X40	63Fx40M	0,76 €
R80X63	80Fx63M	1,07 €
R80X40	80Fx40M	1,07 €
R100X80	100Fx80M	1,33 €
R100X63	100Fx63M	1,33 €
R100X40	100Fx40M	1,40 €
R125X100	125Fx100M	2,22 €
R140X100	140Fx100M	2,30 €
R140X125	140Fx125M	3,11 €
R160X140	160Fx140M	4,00 €
R200X160	200Fx160M	6,23 €

D.	Codice	Riferimenti	Prezzo	D.
595	A32X40	40Mx32F	0,44 €	359
450	A40X50	50Mx40F	0,71 €	134
200	A40X63	63Mx40F	0,76 €	175
90	A40X80	80Mx40F	1,07 €	109
20	A40X100	100Mx40F	1,33 €	105
87	A63X80	80Mx63F	1,07 €	44
20	A63X100	100Mx63F	1,33 €	59
165	A80X100	100Mx80F	1,33 €	99
34	A100X125	125Mx100F	2,22 €	33
2	A100X140	140Mx100F	3,11 €	30
32	A125X140	140Mx125F	3,11 €	13
8	A140X160	160Mx140F	4,00 €	55
35	A160X200	200Mx160F	6,23 €	47

D.	Codice	Riferimenti	Prezzo	D.
0	TV32	D. 32	2,54 €	0
59	TV40	D. 40	0,81 €	59
172	TV50	D. 50	1,60 €	172
95	TV63	D. 63	2,04 €	95
265	TV80	D. 80	2,22 €	265
299	TV100	D. 100	2,67 €	299
228	TV125	D. 125	3,56 €	228
41	TV140	D. 140	5,78 €	41
46	TV160	D. 160	7,74 €	46
56	TV200	D. 200	10,22 €	56



Valvola



Sifone O-O

Codice	Riferimenti	Prezzo
VA100	D. 100	66,70 €
VA125	D. 125	75,60 €
VA140	D. 140	80,04 €
VA160	D. 160	124,51 €
VA200	D. 200	142,30 €

D.	Codice	Riferimenti	Prezzo	D.
29	SOO100	D. 100	13,34 €	64
8	SOO125	D. 125	17,79 €	58
5				
5				
5				

D.	Codice	Riferimenti	Prezzo	D.
10	SVO100	D. 100	17,79 €	10
25	SVO125	D. 125	22,23 €	25



Valvola Antiriflusso Bianca 40X40

Codice	Riferimenti	Prezzo	D.
0750AR64B0	40x40	12,07 €	2
0750AR54B0	32x32	12,95 €	18



Giunto Riparazione

D.

Codice	Riferimenti	Prezzo
GR100	D. 100	€ 7,11
GR125	D. 125	€ 10,67

Giunto scorrevole

D.

Codice	Riferimenti	Prezzo
GS80	D. 80	€ 6,23
GS100	D. 100	€ 7,11
GS125	D. 125	€ 10,67

Braga a "V" Doppia

D.

Codice	Riferimenti	Prezzo
BVD100	D. 100	€ 10,67
BVD125	D. 125	€ 16,01



Colla Riempitiva PantaKol

D.

Codice	Riferimenti	Prezzo
TCRP	gr. 125	€ 3,10
TCRPX200	x 200 Pz	€ 2,79
TCRPX500	x 500 Pz	€ 2,48



Colla Riempitiva

D.

Codice	Riferimenti	Prezzo
BCRP	gr. 500	€ 8,92
BCRP700	gr. 700	€ 12,96

Bocchettone Terrazzo PVC

D.

Codice	Riferimenti	Prezzo
BPA100	D. 100	€ 8,82
BPA125	D. 125	€ 18,28
BP100	D. 100	€ 8,82
BP125	D. 125	€ 9,80

Braga a "V" Scagno

D.

Codice	Riferimenti	Prezzo
BVS100	D. 100	€ 18,31
BVS125	D. 125	€ 27,33



Pozzetto con coperchio 20x20



Collare per Pluviale

Pozzetto con coperchio 20x20

D.

Codice	Riferimenti	Prezzo
PUC20PP	20x20	€ 4,39

Codice	Riferimenti	Prezzo
TC30S	30x30	€ 13,76
TC40S	40x40	€ 21,51
TC55S	55x55	€ 77,42

Codice	Riferimenti	Prezzo
CL32	D. 32	€ 0,55
CL40	D. 40	€ 0,76
CL50	D. 50	€ 0,70
CL60	D. 63	€ 0,84
CL80	D. 80	€ 0,84
CL100	D. 100	€ 0,87
CL125	D. 125	€ 0,96
CL140	D. 140	€ 0,89
CL160	D. 160	€ 0,96
CL200	D. 200	€ 4,07

Codice	Riferimenti	Prezzo
PUC30PP	30x30	€ 10,63



Pozzetto con coperchio 20x20

Codice	Riferimenti	Prezzo
PUC40PP	40x40	€ 21,76

Codice	Riferimenti	Prezzo
UTG20PP	200X200	€ 3,44
UTG30PP	300X300	€ 6,88
UTG40PP	400X400	€ 13,76
UTG55PP	550X550	€ 32,69

Telaio Con Coperchio



Chiusino Laterale



Chiusino

Codice	Riferimenti	Prezzo
UTC20PP	200X200	€ 3,44
UTC30PP	300X300	€ 6,88
UTC40PP	400X400	€ 13,76
UTC55PP	550X550	€ 32,69

Codice	Riferimenti	Prezzo
CHRLQ	Grigio	€ 3,74
CHRLQCRO	Cromo	€ 9,36

Codice	Riferimenti	Prezzo
CS10PP	10X10	€ 1,41
CS15PP	15X15	€ 2,25





Tubo in PP 2 Bicchiere

Codice	Riferimenti	Prezzo	Off. Pubbico	D.
VS0501201	cm. 50D. 32	€ 2,65	€ 2,32	50
VS0501203	MT. 1,00D. 32	€ 3,48	€ 3,05	213
VS0501205	MT. 2,00D. 32	€ 6,41	€ 5,61	4
VS0501207	MT. 3,00D. 32	€ 8,73	€ 7,64	0
VS0501213	cm. 50D. 40	2,12 €	€ 1,85	43
VS0501215	MT. 1,00D. 40	3,12 €	€ 2,73	64
VS0501217	MT. 2,00D. 40	5,48 €	€ 4,80	34
VS0501219	MT. 3,00D. 40	8,22 €	€ 7,19	60
VS0501225	cm. 50D. 50	2,65 €	€ 2,32	251
VS0501227	MT. 1,00D. 50	3,81 €	€ 3,33	90
VS0501229	MT. 2,00D. 50	7,29 €	€ 6,38	217
VS0501231	MT. 3,00D. 50	10,87 €	€ 9,51	67
VS0501281	cm. 50D. 90	6,60 €	€ 5,77	19
VS0501283	MT. 1,00D. 90	9,85 €	€ 8,62	22
VS0501285	MT. 2,00D. 90	17,47 €	€ 15,28	7
VS0501287	MT. 3,00D. 90	26,11 €	€ 22,84	16
VS0501249	cm. 50D. 110	7,90 €	€ 6,91	50
VS0501251	MT. 1,00D. 110	11,23 €	€ 9,83	66
VS0501253	MT. 2,00D. 110	20,81 €	€ 18,21	19
VS0501255	MT. 3,00D. 110	30,10 €	€ 26,34	0



Tubo in PP 1 Bicchiere

Codice	Riferimenti	Prezzo	Off. Pubbico	D.
VS0501005	cm. 50D. 32	1,90 €	€ 1,67	94
VS0501009	MT. 1,00D. 32	3,02 €	€ 2,64	40
VS0501013	MT. 2,00D. 32	5,67 €	€ 4,96	37
VS0501015	MT. 3,00D. 32	8,36 €	€ 7,32	86
VS0501025	cm. 50D. 40	1,75 €	€ 1,53	57
VS0501029	MT. 1,00D. 40	2,67 €	€ 2,33	170
VS0501033	MT. 2,00D. 40	5,16 €	€ 4,51	98
VS0501035	MT. 3,00D. 40	7,57 €	€ 6,63	76
VS0501045	cm. 50D. 50	2,12 €	€ 1,85	210
VS0501049	MT. 1,00D. 50	3,39 €	€ 2,97	49
VS0501053	MT. 2,00D. 50	6,50 €	€ 5,69	81
VS0501055	MT. 3,00D. 50	9,48 €	€ 8,29	103
VS0501145	cm. 50D. 90	5,39 €	€ 4,72	60
VS0501149	MT. 1,00D. 90	8,64 €	€ 7,56	139
VS0501153	MT. 2,00D. 90	16,45 €	€ 14,39	11
VS0501155	MT. 3,00D. 90	24,99 €	€ 21,87	31
VS0501085	cm. 50D. 110	6,13 €	€ 5,37	60
VS0501089	MT. 1,00D. 110	9,48 €	€ 8,29	57
VS0501093	MT. 2,00D. 110	18,39 €	€ 16,10	36
VS0501095	MT. 3,00D. 110	27,87 €	€ 24,39	36



Braga Semplice a 45° in PP

Codice	Riferimenti	Prezzo	Off. Pubbico	D.
VS0508001	D. 40	2,18 €	€ 1,91	11
VS0508007	D. 50	1,60 €	€ 1,40	10
VS0508013	D. 90	2,02 €	€ 1,77	68
VS0599061	D. 110	5,48 €	€ 4,80	37
VS0508025	D. 125	5,39 €	€ 4,72	20



Braga Semplice a 90° in PP

Codice	Riferimenti	Prezzo	Off. Pubbico	D.
VS0508005	D. 40	2,23 €	€ 1,95	50
VS0508011	D. 50	1,60 €	€ 1,40	104
VS0508017	D. 90	2,09 €	€ 1,83	114
VS0599065	D. 110	5,48 €	€ 4,80	136
VS0508029	D. 125	5,39 €	€ 4,72	21



Curva MF a 90° in PP

Codice	Riferimenti	Prezzo	Off. Pubbico	D.
VS0504011	D. 40	0,93 €	€ 0,81	28
VS0504023	D. 50	0,82 €	€ 0,72	249
VS0504035	D. 90	1,07 €	€ 0,93	231
VS0599051	D. 110	2,79 €	€ 2,44	0
VS0504059	D. 125	3,34 €	€ 2,93	84



Curva MF a 45° in PP

Codice	Riferimenti	Prezzo	Off. Pubbico	D.
VS0504005	D. 40	0,93 €	€ 0,81	45
VS0504017	D. 50	0,82 €	€ 0,72	231
VS0504029	D. 90	1,03 €	€ 0,90	36
VS0599045	D. 110	2,79 €	€ 2,44	24
VS0504053	D. 125	3,30 €	€ 2,89	56



Braga ridotta 87° 30"

Codice	Riferimenti	Prezzo	Off. Pubbico	D.
VS0599075	D.90/40	3,63 €	€ 3,18	0
VS0599077	D.90/50	3,90 €	€ 3,41	16
VS0510029	D.110/40	3,74 €	€ 3,28	9
VS0510035	D.110/50	3,67 €	€ 3,21	14



Tronchetto per collegamento Pvc

Codice	Riferimenti	Prezzo	Off. Pubbico	D.
VS0530001	D.40	3,34 €	€ 2,93	222
VS0530003	D.50	3,81 €	€ 3,33	474
VS0599121	D.90	8,60 €	€ 7,53	11
VS0530007	D.110	7,06 €	€ 6,18	73



Pp Curva Wc Prolung Dn 110-90'

Codice	Riferimenti	Prezzo	Off. Pubbico	D.
BSBPR0090	110-90°	9,48 €	€ 8,29	0
BSBPR0990	90°-90°	8,83 €	€ 7,72	0



Pvc-Pp Racc Passagg Dn 100-110

Codice	Riferimenti	Prezzo	Off. Pubbico	D.
BPV100110	110-110	5,11 €	€ 4,47	0



Collare Riparazione 1 Tirante

Codice	Riferimenti	Prezzo	Off. Pubbico	D.
030200	21/25	9,11 €	€ 7,97	77
030201	26/30	9,11 €	€ 7,97	76
030202	33/37	9,56 €	€ 8,37	38
030203	42/45	10,48 €	€ 9,17	21
030204	48/51	10,48 €	€ 9,17	16
030205	60/64	14,35 €	€ 12,55	4



HTEA braga ridotta 45°

Codice	Riferimenti	Prezzo	Off. Pubbico	D.
VS0510001	D.40/32	2,40 €	€ 2,10	140
VS0599071	D.90/40	3,63 €	€ 3,17	21
VS0599073	D.90/50	3,74 €	€ 3,27	39
VS0510025	D.110/40	3,11 €	€ 2,72	7
VS0599089	D.110/90	9,79 €	€ 8,57	0
VS0510031	D.110/50	3,64 €	€ 3,19	6



Pp Braga Doppia 90-90-90-87'

Codice	Riferimenti	Prezzo	Off. Pubbico	D.
BDA090987	90-90-90	14,40 €	€ 12,60	20



Pp Braga Doppia 110-110-110-67'

Codice	Riferimenti	Prezzo	Off. Pubbico	D.
BDA111167	110-110-110	15,79 €	€ 13,82	3



Sella Dm.100/40 Pvc Grigio

Codice	Riferimenti	Prezzo	Off. Pubbico	D.
SL104	100X40	5,55 €	€ 4,85	102



Pvc Curva Ridotta 110-100-87'

Codice	Riferimenti	Prezzo	Off. Pubbico	D.
BPV111087	110-110	8,45 €	€ 7,39	15



Riduzione Ecc.Pp Htr D. 40/32

Codice	Riferimenti	Prezzo	Off. Pubbico	D.
VS0514001	A. . 40-32	1,37 €	€ 1,20	138
VS0514002	A. . 50-32	1,61 €	€ 1,41	56
VS0514003	A. . 50-40	0,94 €	€ 0,82	60



**Politilene Alta densità Pn 25**

Codice	Riferimenti	Prezzo	Off. Pubbico D.
PN2025	D. 20-1/2"	1,87 €	€ 1,64 700
PN2525	D. 25-3/4"	2,76 €	€ 2,42 520
PN3225	D. 32-1"	3,09 €	€ 2,71 1000
PN4025	D. 40-11/4"	4,83 €	€ 4,22 600

**Politilene Alta densità Pn 16**

Codice	Riferimenti	Prezzo	Off. Pubbico D.
PN2016	D. 20-1/2"	1,45 €	€ 1,27 700
PN2516	D. 25-3/4"	1,42 €	€ 1,24 813
PN3216	D. 32-1"	2,21 €	€ 1,93 799
PN4016	D. 40-11/4"	4,13 €	€ 3,62 415

**Politilene Bassa Densità PELD Pn10**

Codice	Riferimenti	Prezzo	Off. Pubbico D.
PN2010	D. 20-1/2"	1,35 €	€ 1,18 4770
PN2510	D. 25-3/4"	1,97 €	€ 1,73 2685
PN3210	D. 32-1"	3,21 €	€ 2,81 2100
PN4010	D. 40-11/4"	4,94 €	€ 4,33 665

**Politilene Bassa Densità Pn 6**

Codice	Riferimenti	Prezzo	Off. Pubbico D.
P620	D. 20-1/2"	0,95 €	€ 0,83 2000
P625	D. 25-3/4"	1,41 €	€ 1,23 2000
P632	D. 32-1"	2,30 €	€ 2,01 1900
P640	D. 40-11/4"	3,52 €	€ 3,08 0

**Politilene Riplast Bassa Densità Pn 10**

Codice	Riferimenti	Prezzo	Off. Pubbico D.
P20	D. 20-1/2"	0,73 €	€ 0,64 4940
P25	D. 25-3/4"	1,14 €	€ 0,99 2184
P32	D. 32-1"	1,85 €	€ 1,62 1202

**Tubi Corrugati In Hpd Cav 40**

Codice	Riferimenti	Prezzo	Off. Pubbico D.
CAV40	D. 40	1,62 €	€ 1,42 400
CAV50	D. 50	1,95 €	€ 1,70 400
CAV63	D. 63	2,40 €	€ 2,10 0

**Nipples Maschio Politilene D. 1/2" X 20**

Visualizza la gamma completa

Codice	Riferimenti	Prezzo	Off. Pubbico D.
NM20PB	1/2"x20	2,26 €	€ 1,98 173
NM25PB	3/4"x25	3,66 €	€ 3,20 81
NM32PB	1"x32	6,25 €	€ 5,47 212
NM40PB	1 1/4"x40	10,68 €	€ 9,35 197

**Niples Femmina Politilene D. 1/2" X 20**

Visualizza la gamma completa

Codice	Riferimenti	Prezzo	Off. Pubbico D.
NF20PB	1/2"x20	2,41 €	€ 2,11 209
NF25PB	3/4"x25	3,54 €	€ 3,10 135
NF32PB	1"x32	5,89 €	€ 5,16 377
NF40PB	1 1/4"x40	10,46 €	€ 9,15 103

**Nipples Doppio Politilene D. 20**

Visualizza la gamma completa

Codice	Riferimenti	Prezzo	Off. Pubbico D.
N20PB	20x20	3,66 €	10 € 3,20 274
N25PB	25x25	5,55 €	10 € 4,85 676
N32PB	32x32	9,35 €	10 € 8,18 521
N40PB	40x40	15,69 €	5 € 13,72 241

**Gomito Doppio 20 Politilene**

Visualizza la gamma completa

Codice	Riferimenti	Prezzo	Off. Pubbico D.
G20PB	20x20	4,42 €	10 € 3,86 138
G25PB	25x25	6,36 €	10 € 5,56 599
G32PB	32x32	11,24 €	10 € 9,84 351
G40PB	40x40	18,46 €	5 € 16,15 190

Visualizza la gamma completa



Gomito Femmina  
Polidilene D. 1/2" X 20

[Visualizza la gamma completa](#)

Codice	Riferimenti	Prezzo	Off. Pubbico	D.
GF20PB	1/2"x20	3,26 €	10	€ 2,85 208
GF25PB	3/4"x25	5,23 €	10	€ 4,57 234
GF32PB	1"x32	7,72 €	10	€ 6,75 666
GF40PB	1 1/4"x40	14,72 €	5	€ 12,88 154



Tee Polidilene 3 Lati D. 20

[Visualizza la gamma completa](#)

Codice	Riferimenti	Prezzo	Off. Pubbico	D.
T20PB	20x20	6,08 €	10	€ 5,32 930
T25PB	25x25	8,89 €	10	€ 7,78 725
T32PB	32x32	15,91 €	10	€ 13,92 1029
T40PB	40x40	26,20 €	5	€ 22,92 120



Raccordo Compressione  
M 20X3/4"

[Visualizza la gamma completa](#)

Codice	Riferimenti	Prezzo	Off. Pubbico	D.
330-G20	20x3/4"	0,82 €	10	€ 0,71 520
330-G25	25x3/4"	1,05 €	10	€ 0,92 804
330-H32	32x1"	1,08 €	10	€ 0,94 603
330-HB40	40x1 1/4"	2,54 €	5	€ 2,22 217



Gomito Doppio 90° 20X20

[Visualizza la gamma completa](#)

Codice	Riferimenti	Prezzo	Off. Pubbico	D.
332-20	D. 20	1,49 €	10	€ 1,31 678
332-25	D. 25	1,62 €	10	€ 1,41 373
332-32	D. 32	3,54 €	10	€ 3,10 310
332-40	D. 40	4,61 €	5	€ 4,03 185



Tee 90° F 20X1/2"

[Visualizza la gamma completa](#)

Codice	Riferimenti	Prezzo	Off. Pubbico	D.
333-D20	20x1/2"	1,47 €	10	€ 1,29 251
333-G25	25x3/4"	1,88 €	10	€ 1,64 417
333-H32	32x1"	2,96 €	10	€ 2,59 12
333-HB40	40x1 1/4"	5,44 €	5	€ 4,76 28



Gomito 90° Maschio  
1/2"X20

[Visualizza la gamma completa](#)

Codice	Riferimenti	Prezzo	Off. Pubbico	D.
332A-D20	1/2"x20	1,06 €	10	€ 0,93 197
332A-G25	3/4"x25	1,29 €	10	€ 1,13 360
332A-H32	1"x32	1,59 €	10	€ 1,39 15
332A-HB40	1 1/4"x40	2,66 €	5	€ 2,32 177



Gomito Maschio Polidilene  
D. 1/2" X 20

[Visualizza la gamma completa](#)

Codice	Riferimenti	Prezzo	Off. Pubbico	D.
GM20PB	1/2"x20	3,30 €	10	€ 2,89 162
GM25PB	3/4"x25	5,16 €	10	€ 4,52 276
GM32PB	1"x32	8,90 €	10	€ 7,79 171
GM40PB	1 1/4"x40	15,94 €	5	€ 13,95 54



Tees Femmina Polidilene  
D. 1/2" X 20

[Visualizza la gamma completa](#)

Codice	Riferimenti	Prezzo	Off. Pubbico	D.
TF20PB	1/2"x20	4,90 €	10	€ 4,28 390
TF25PB	3/4"x25	7,30 €	10	€ 6,39 172
TF32PB	1"x32	11,92 €	10	€ 10,43 348
TF40PB	1 1/4"x40	21,01 €	5	€ 18,39 38



Raccordo Compressione  
F 20X1/2"

Codice	Riferimenti	Prezzo	Off. Pubbico	D.
330A-D20	20x3/4"	1,59 €	10	€ 1,39 889
330A-G25	25x3/4"	1,22 €	10	€ 1,06 526
330A-H32	32x1"	1,23 €	10	€ 1,08 482
330A-HB40	40x1 1/4"	2,24 €	5	€ 1,96 299



Nipples Doppio 20X20

[Visualizza la gamma completa](#)

Codice	Riferimenti	Prezzo	Off. Pubbico	D.
331-20	D. 20	1,32 €	10	€ 1,16 217
331-25	D. 25	1,53 €	10	€ 1,34 452
331-32	D. 32	1,96 €	10	€ 1,71 142
331-40	D. 40	4,22 €	5	€ 3,69 226



Tee 90° Tre Lati D. 20

[Visualizza la gamma completa](#)

Codice	Riferimenti	Prezzo	Off. Pubbico	D.
334-20	D. 20	1,73 €	10	€ 1,51 621
334-25	D. 25	2,30 €	10	€ 2,01 339
334-32	D. 32	2,98 €	10	€ 2,61 276
334-40	D. 40	5,19 €	5	€ 4,54 128



Gomito Polidilene F.  
1/2"X20

[Visualizza la gamma completa](#)

Codice	Riferimenti	Prezzo	Off. Pubbico	D.
332B-D20	1/2"x20	1,14 €	10	€ 1,00 1217
332B-G25	3/4"x25	1,25 €	10	€ 1,09 559
332B-H32	1"x32	1,55 €	10	€ 1,36 361
332B-HB40	1 1/4"x40	3,08 €	5	€ 2,69 276





Tubo Polipropilene 32X5,4  
Zzfusiotherm Faser Sdr 6  
Barra 4 Mt Prezzo Metro

[Visualizza la gamma completa](#)

Codice	Riferimenti	Prezzo	Off. Pubbico	D.
TA20X3,4	D.. 20	1,49 €	€ 1,31	512
TA25X4,2	D.. 25	2,38 €	€ 2,08	952
TA32X5,4	D.. 32	4,39 €	€ 3,84	808
TA40X6,7	D.. 40	7,33 €	€ 6,41	720



Tee Maschio Polipropilene  
1/2X20

[Visualizza la gamma completa](#)

Codice	Riferimenti	Prezzo	Off. Pubbico	D.
TMA1\2X20	1/2"x20	4,87 €	€ 4,26	100
TMA3\4X25	3/4"x25	6,63 €	€ 5,80	40



Gomito Filettato Maschio  
1/2"X25

[Visualizza la gamma completa](#)

Codice	Riferimenti	Prezzo	Off. Pubbico	D.
GAM1\2X20	1/2"x20	2,88 €	€ 2,52	209
GAM3\4X20	3/4"x20	5,21 €	€ 4,56	281
GAM1\2X25	1/2"X25	4,87 €	€ 4,26	230
GAM3\4X25	3/4"X25	5,26 €	€ 4,61	336
GAM3\4X32	3/4"X32	9,75 €	€ 8,53	177
GAM1X32	1"X32	12,18 €	€ 10,66	230



Gomito Femmina  
Polipropilene 3/4"X25

[Visualizza la gamma completa](#)

Codice	Riferimenti	Prezzo	Off. Pubbico	D.
GFA1\2X20	1/2"x20	2,44 €	€ 2,13	205
GFA3\4X20	3/4"x20	3,66 €	€ 3,20	379
GFA3\4X25	3/4"x25	4,39 €	€ 3,84	498
GFA3\4X32	3/4"X32	5,65 €	€ 4,95	97
GFA1X32	1"X32	9,75 €	€ 8,53	244



Tee Femmina Polipropilene  
3/4X32

[Visualizza la gamma completa](#)

Codice	Riferimenti	Prezzo	Off. Pubbico	D.
TFA1\2X20	1/2"x20	3,31 €	€ 2,90	344
TFA3\4X25	3/4"x25	5,07 €	€ 4,44	273
TFA3\4X32	3/4"X32	7,41 €	€ 6,48	100
TFA1X32	1"X32	10,33 €	€ 9,04	72



Raccordo Retto Con Dado  
Girevole 11/2 F X 40

[Visualizza la gamma completa](#)

Codice	Riferimenti	Prezzo	Off. Pubbico	D.
RRGA3\4X20	3/4"X20	10,23 €	€ 8,96	248
RRGA1X32	1"X32	26,32 €	€ 23,03	87
RRGA11\2X40	1"1/2X40	19,40 €	€ 16,97	8
RRGA2X50	2"X50	43,22 €	€ 37,82	0
RRGA21\2X63	21/2"X63	60,99 €	€ 53,37	2



Niples Maschio Polipropilene  
D. 3/4"X20

[Visualizza la gamma completa](#)

Codice	Riferimenti	Prezzo	Off. Pubbico	D.
NMA1\2X20	1/2"x20	3,02 €	€ 2,64	325
NMA1\2X25	1/2"x25	4,68 €	€ 4,09	301
NMA3\4X20	3/4"x20	4,97 €	€ 4,35	348
NMA3\4X25	3/4"x25	4,87 €	€ 4,26	519
NMA11\4X40	11/4"x40	21,44 €	€ 18,76	97
NMA11\2X50	11/2"x50	24,86 €	€ 21,75	72
NMA2X63	2"x63	38,50 €	€ 33,69	56



Niples Femmina  
Polipropilene D.3/4"X20

[Visualizza la gamma completa](#)

Codice	Riferimenti	Prezzo	Off. Pubbico	D.
NFA1\2X20	1/2"x20	2,63 €	€ 2,30	195
NFA1\2X25	1/2"x25	4,19 €	€ 3,67	587
NFA3\4X20	3/4"x20	3,95 €	€ 3,45	340
NFA3\4X25	3/4"x25	4,00 €	€ 3,50	286
NFA11\4X40	11/4"x40	19,98 €	€ 17,48	88
NFA11\2X50	11/2"x50	22,42 €	€ 19,62	100
NFA2X63	2"x63	36,07 €	€ 31,56	62



Manicotto Polipropilene Ff D.  
32

[Visualizza la gamma completa](#)

Codice	Riferimenti	Prezzo	Off. Pubbico	D.
MA20	20x20	0,33 €	€ 0,29	1418
MA25	25x25	0,50 €	€ 0,44	856
MA32	32x32	0,73 €	€ 0,64	663
MA40	40x40	1,80 €	€ 1,58	231
MA50	50x50	2,58 €	€ 2,26	156
MA63	63x63	5,82 €	€ 5,09	14
MA75	75X75	10,54 €	€ 9,22	4



Gomito Ff Polipropilene Da  
32

[Visualizza la gamma completa](#)

Codice	Riferimenti	Prezzo	Off. Pubbico	D.
GA20	20x20	0,44 €	€ 0,38	88
GA25	25x25	0,58 €	€ 0,50	944
GA32	32x32	0,88 €	€ 0,77	437
GA40	40x40	2,10 €	€ 1,83	301
GA50	50x50	4,00 €	€ 3,50	191
GA63	63x63	8,98 €	€ 7,86	171
GA75	75X75	14,48 €	€ 12,67	4



Tee Polipropilene Da 32

[Visualizza la gamma completa](#)

Codice	Riferimenti	Prezzo	Off. Pubbico	D.
TA20	20x20x20	0,50 €	€ 0,43	19
TA25	25x25x25	0,58 €	€ 0,50	546
TA32	32x32x32	0,96 €	€ 0,84	267
TA40	40x40x40	2,24 €	€ 1,96	172
TA50	50x50x50	4,78 €	€ 4,18	180
TA63	63x63x63	9,79 €	€ 8,57	43
TA75	75X75x75	22,92 €	€ 20,05	16



Curva Aperta Polipropilene  
D.32

[Visualizza la gamma completa](#)

Codice	Riferimenti	Prezzo	Off. Pubbico	D.
CAA20	20x20	0,55 €	€ 0,48	547
CAA25	25x25	0,79 €	€ 0,69	396
CAA32	32x32	1,25 €	€ 1,09	310
CAA40	40x40	2,05 €	€ 1,79	84
CAA50	50x50	4,63 €	€ 4,05	41
CAA63	63x63	7,70 €	€ 6,74	12
CAA75	75X75	9,82 €	€ 8,59	2



Riduzion Polipropilene  
32X25 M/F

[Visualizza la gamma completa](#)

Codice	Riferimenti	Prezzo	Off. Pubbico	D.
RA25X20	20x25	0,47 €	€ 0,41	190
RA32X20	20x32	0,58 €	€ 0,51	138
RA32X25	25x32	0,68 €	€ 0,60	271
RA40X32	32x40	1,56 €	€ 1,36	57
RA50X32	32x50	2,44 €	€ 2,13	30
RA50X40	40x50	2,44 €	€ 2,13	30
RA63X50	50x63	4,58 €	€ 4,01	18
RA75X63	63x75	4,55 €	€ 3,98	0



Sorpasso Sald. Polipropilene  
20

[Visualizza la gamma completa](#)

Codice	Riferimenti	Prezzo	Off. Pubbico	D.
SSA20	20x20	1,66 €	€ 1,45	20
SSA25	25x25	2,63 €	€ 2,30	192



Gomit Flang. Polipropilene  
1/2"X20

Codice	Riferimenti	Prezzo	Off. Pubbico	D.
GFLA1/2X20	1/2"x20	2,92 €	€ 2,56	601



Rubinetto A Sfera Con  
Maniglia Dn 20

Codice	Riferimenti	Prezzo	Off. Pubbico	D.
RIA20	D.. 20x20	31,19 €	€ 27,29	71
RIA25	D.. 25x25	32,17 €	€ 28,15	158



Rubinetto D'Arresto A Vitone  
Con Cappuccio D. 20

Codice	Riferimenti	Prezzo	Off. Pubbico	D.
RCA20	D.. 20x20	14,13 €	€ 12,37	0
RCA25	D.. 25x25	16,57 €	€ 14,50	29



Rubinetto D'Arresto A Vitone  
Con Maniglia D 20

Codice	Riferimenti	Prezzo	Off. Pubbico	D.
RIAP20	D.. 20x20	21,02 €	€ 18,39	26
RIAP25	D.. 25x25	24,29 €	€ 21,25	77



Rubinetto D'Arresto A Spera  
Con Cappuccio D. 20

Codice	Riferimenti	Prezzo	Off. Pubbico	D.
RICA20	D.. 20x20	25,83 €	€ 22,60	35
RICA25	D.. 25x25	27,78 €	€ 24,31	40





Manicotto Rid. G. Ff  
1/2"X3/8"

[Visualizza la gamma completa](#)

Codice	Riferimenti	Prezzo	Off. Pubbico	D.
MRG1\2X3\8	1/2X3/8 FF	0,92 €	10	€ 0,80 194
MRG3\4X1\2	3/4X1/2 FF	1,42 €	10	€ 1,24 395
MRG1X1\2	1"X1/2 FF	2,20 €	10	€ 1,92 375
MRG1X3\4	1"X3/4 FF	2,43 €	10	€ 2,13 350



Prolunga Rid. Ott. G.  
3/4"X1/2"

[Visualizza la gamma completa](#)

Codice	Riferimenti	Prezzo	Off. Pubbico	D.
PRG3\4X1\2	3/4X1/2 FM	2,26 €	10	€ 1,97 133
PRG1X1\2	1"X1/2 FM	1,96 €	10	€ 1,71 324
PRG1X3\4	1"X3/4 FM	3,32 €	10	€ 2,91 191
PRG11\4X1	11/4X1 FM	5,10 €	10	€ 4,46 247



Gomito Giallo Ridotto  
3/4"X1/2"

[Visualizza la gamma completa](#)

Codice	Riferimenti	Prezzo	Off. Pubbico	D.
GGRGD	1/2"x3/8"		10	
GGRHD	3/4x1/2"	2,05 €	10	€ 1,79 145
GGRHG	1"x1/2"	7,31 €	10	€ 6,40 78
GGRHG	1"x3/4"	3,65 €	10	€ 3,19 11



Raccordo Tre Vie Gialla  
D. 1" Maschio

Codice	Riferimenti	Prezzo	Off. Pubbico	D.
TG1M	1"	8,68 €	10	€ 7,60 51



Riduzione Gialla 1/2"X3/8"

[Visualizza la gamma completa](#)

Codice	Riferimenti	Prezzo	Off. Pubbico	D.
RG1\2X3\8	1/2"x3/8"	0,45 €	10	€ 0,39 148
RG3\4X1\2	3/4x1/2"	1,29 €	10	€ 1,13 1244
RG1X1\2	1"x1/2"	2,05 €	10	€ 1,80 654
RG1X3\4	1"x3/4"	1,74 €	10	€ 1,52 1230
RG11\4X1	1"1/4X1"	3,02 €	10	€ 2,65 244



Controdado Flangia Giallo  
1/2"

Codice	Riferimenti	Prezzo	Off. Pubbico	D.
CF1\2	1/2"	0,79 €	10	€ 0,69 404
CF3\4	3/4"	1,04 €	10	€ 0,91 183
CF1	1"	1,25 €	10	€ 1,09 59
CF11\4	1" 1/4	1,46 €	10	€ 1,28 477



Prolunga in Ottone Giallo

[Visualizza la gamma completa](#)

Prolunga Ott. G. 1/2"X10 P.

Codice	Riferimenti	Prezzo	Off. Pubbico	D.
PG1\2X10P	1\2"X10 mm	1,29 €	10	€ 1,13 2220
PG1\2X15P	1\2"X15 mm	1,34 €	10	€ 1,17 795
PG1\2X20P	1\2"X20 mm	1,67 €	10	€ 1,47 286
PG1\2X25P	1\2"X25 mm	1,49 €	10	€ 1,30 698

Prolunga Gialla 3/4"X10 Pes.

Codice	Riferimenti	Prezzo	Off. Pubbico	D.
PG3\4X10P	3\4"X10 mm	2,44 €	10	€ 2,14 480
PG3\4X15P	3\4"X15 mm	2,11 €	10	€ 1,85 51
PG3\4X20P	3\4"X20 mm	2,63 €	10	€ 2,30 465
PG3\4X25P	3\4"X25 mm	1,76 €	10	€ 1,54 224

Prolunga Gialla Pes. 1"X10

Codice	Riferimenti	Prezzo	Off. Pubbico	D.
PG1X10P	1"X10 mm	3,74 €	10	€ 3,27 275
PG1X15P	1"X15 mm	3,22 €	10	€ 2,82 140
PG1X20P	1"X20 mm	3,65 €	10	€ 3,20 272
PG1X25P	1"X25 mm	3,75 €	10	€ 3,28 0



Raccordo 3 Pz Ott. Giallo  
1/2"

Codice	Riferimenti	Prezzo	Off. Pubbico	D.
BG1\2	1/2"	6,67 €	10	€ 5,83 190
BG3\4	3/4"	8,48 €	10	€ 7,42 109
BG1	1"	10,81 €	10	€ 9,46 85
BG11\4	1" 1/4	18,96 €	10	€ 16,59 35
BG11\2	1" 1/2	26,50 €	10	€ 23,18 85
BG2	2"	40,28 €	10	€ 35,24 30



Riduzione Ottone Giallo  
1/2"X3/8" Prolungata

Codice	Riferimenti	Prezzo	Off. Pubbico	D.
RG1\2X3\8P	1/2"x3/8"	0,98 €	10	€ 0,86 1237
RG3\4X1\2P	3/4x1/2"	1,52 €	10	€ 1,33 1224



Raccordo 3 Pz Ott. Giallo  
1/2" Mf

Codice	Riferimenti	Prezzo	Off. Pubbico	D.
BG1\2MF	1/2"	4,91 €	10	€ 4,29 224
BG3\4MF	3/4"	7,23 €	10	€ 6,32 236
BG1MF	1"	10,84 €	10	€ 9,49 335
BG11\4MF	1" 1/4	15,70 €	10	€ 13,74 71

Gomito Giallo Da 1/2" Ff



Visualizza la gamma completa

Codice	Riferimenti	Prezzo	Off. Pubbico	D.
GG1\2	1/2" FF	1,61 €	10	€ 1,41 1800
GG3\4	3/4" FF	3,67 €	10	€ 3,21 581
GG1	1" FF	4,73 €	10	€ 4,14 812
GG11\4	1"1/4 FF	7,45 €	10	€ 6,52 189

Gomito Giallo Da 1/2" Mf



Visualizza la gamma completa

Codice	Riferimenti	Prezzo	Off. Pubbico	D.
GG1\2MF	1/2" MF	2,58 €	10	€ 2,26 1400
GG3\4MF	3/4" MF	3,35 €	10	€ 2,93 1041
GG1MF	1" MF	6,39 €	10	€ 5,60 217
GG11\4MF	1"1/4 MF	8,58 €	10	€ 7,51 124

Raccordo Tre Vie Gialla  
D. 1/2"



Visualizza la gamma completa

Codice	Riferimenti	Prezzo	Off. Pubbico	D.
TG1\2	1/2" FFF	2,84 €	10	€ 2,49 1559
TG3\4	3/4" FFF	4,46 €	10	€ 3,90 602
TG1	1" FFF	7,58 €	10	€ 6,64 427
TG11\4	1"1/4 FFF	9,24 €	10	€ 8,08 145

Manicotto Giallo 1/2"



Visualizza la gamma completa

Codice	Riferimenti	Prezzo	Off. Pubbico	D.
MG1\2	1/2" FF	1,43 €	10	€ 1,25 844
MG3\4	3/4" FF	1,68 €	10	€ 1,47 263
MG1	1" FF	3,83 €	10	€ 3,35 461
MG11\4	1"1/4 FF	4,68 €	10	€ 4,10 180

Niplo Giallo Da 1/2"



Visualizza la gamma completa

Codice	Riferimenti	Prezzo	Off. Pubbico	D.
NG1\4	1/4" MM	0,39 €	10	€ 0,34 32
NG3\8	3/8" MM	0,78 €	10	€ 0,68 346
NG1\2	1/2" MM	1,07 €	10	€ 0,94 3711
NG3\4	3/4" MM	1,86 €	10	€ 1,63 1664
NG1	1" MM	2,83 €	10	€ 2,47 663
NG11\4	1"1/4 MM	3,66 €	10	€ 3,20 212

Niples Rid.Ott. G.  
3/4"X1/2"



Visualizza la gamma completa

Codice	Riferimenti	Prezzo	Off. Pubbico	D.
NRG1\2X1\4	1/2"X 1/4"	0,69 €	10	€ 0,61 128
NRG1\2x3\8	1/2"X 3/8"	1,09 €	10	€ 0,95 218
NRG3\4X1\2	3/4"X 1/2"	1,42 €	10	€ 1,24 1078
NRG1X1\2	1" X 1/2"	2,02 €	10	€ 1,76 615
NRG1X3\4	1" X 3/4"	2,53 €	10	€ 2,21 385
NRG11\4X3\4	1"1/4 X 3/4"	3,40 €	10	€ 2,97 289

Tappo Giallo Maschio D.  
1/2"



Visualizza la gamma completa

Codice	Riferimenti	Prezzo	Off. Pubbico	D.
TGM1\4	1/4" M	0,57 €	10	€ 0,50 235
TGM3\8	3/8" M	0,62 €	10	€ 0,55 614
TGM1\2	1/2" M	0,92 €	10	€ 0,81 2311
TGM3\4	3/4" M	1,44 €	10	€ 1,26 982
TGM1	1" M	1,48 €	10	€ 1,30 1879
TGM11\4	1"1/4 M	3,21 €	10	€ 2,81 250

Tappo Giallo Femmina D.  
1/2"



Visualizza la gamma completa

Codice	Riferimenti	Prezzo	Off. Pubbico	D.
TGF1\4	1/4" F	0,28 €	10	€ 0,25 156
TGF3\8	3/8" F	0,60 €	10	€ 0,52 696
TGF1\2	1/2" F	0,62 €	10	€ 0,54 424
TGF3\4	3/4" F	1,54 €	10	€ 1,34 2978
TGF1	1" F	1,48 €	10	€ 1,30 423
TGF11\4	1"1/4 F	2,69 €	10	€ 2,35 405

Gomito Giallo 3 Pz Mf Da  
1/2"



Codice	Riferimenti	Prezzo	Off. Pubbico	D.
G3G1\2MF	1/2" MF	2,63 €	10	€ 2,30 0
G3G3\4MF	3/4" MF	12,13 €	10	€ 10,62 52
G3G1MF	1" MF	18,48 €	10	€ 16,17 46

Raccordo 3 Pz. Giallo 1/2"  
Mf



Codice	Riferimenti	Prezzo	Off. Pubbico	D.
R3G1\2MF	1/2" MF	2,53 €	10	€ 2,21 145
R3G3\4MF	3/4" MF	3,92 €	10	€ 3,43 309
R3G1MF	1" MF	10,84 €	10	€ 9,49 379
R3G11\4MF	11/4" MF	11,80 €	10	€ 10,33 60





Valvola Tenuta Apm D.  
1/2"



Codice	Riferimenti	Prezzo	Conf.	Off. Pubbico D.
VE1\2A	1/2"	6,31 €	10	€ 5,52 408
VE3\4A	3/4"	10,42 €	10	€ 9,12 246
VE1A	1"	15,85 €	10	€ 13,87 195
VE11\4A	1"1/4	22,51 €	10	€ 19,69 50



Valvola Clapet Da 1/2"



Codice	Riferimenti	Prezzo	Conf.	Off. Pubbico D.
VC1\2	1/2"	5,31 €	10	€ 4,65 23
VC3\4	3/4"	7,52 €	10	€ 6,58 16
VC1	1"	12,31 €	10	€ 10,77 60
VC11\4	1"1/4	18,83 €	10	€ 16,48 68



Valvola Sfera P/T Leva  
1/2"



Codice	Riferimenti	Prezzo	Conf.	Off. Pubbico D.
VS1\2	1/2" FF	5,65 €	10	€ 4,94 800
VS3\4	3/4" FF	8,69 €	10	€ 7,60 390
VS1	1" FF	14,40 €	10	€ 12,60 421
VS11\4	1"1/4 FF	21,84 €	10	€ 19,11 124



Valvola Sfera 1/2" Mf Leva  
Rossa



Codice	Riferimenti	Prezzo	Conf.	Off. Pubbico D.
VS1\2MF	1/2" MF	5,65 €	10	€ 4,94 613
VS3\4MF	3/4" MF	8,38 €	10	€ 7,33 203
VS1MF	1" MF	14,65 €	10	€ 12,81 42
VS11\4MF	1"1/4 MF	22,94 €	10	€ 20,07 322



Valvola Ad Angolo Da  
1/2" Mf



Codice	Riferimenti	Prezzo	Conf.	Off. Pubbico D.
VA1\2	1/2" MF	8,87 €	10	€ 7,76 133
VA3\4	3/4" MF	14,00 €	10	€ 12,25 76
VA1	1" MF	22,75 €	10	€ 19,90 193



Valvola Bocchettone 1/2"  
Mf



Codice	Riferimenti	Prezzo	Conf.	Off. Pubbico D.
VB1\2	1/2" MF	6,92 €	10	€ 6,06 433
VB3\4	3/4" MF	11,28 €	10	€ 9,87 209
VB1	1" MF	19,15 €	10	€ 16,75 67



Valvola Mignon D. 1/2" Mf  
L/Nera



Codice	Riferimenti	Prezzo	Conf.	Off. Pubbico D.
VM1\2N	D. 1/2"	4,24 €	10	€ 3,71 112
VM3\8	D. 3/8"	4,54 €	10	€ 3,97 0



Valvola Mignon Ff 1/2"  
L/Nera



Codice	Riferimenti	Prezzo	Conf.	Off. Pubbico D.
VM1\2FN	D. 1/2"	3,74 €	10	€ 3,27 660
VM3\8F	D. 3/8"	2,72 €	10	€ 2,38 0



Valvola Mignon 1/2" Cr.  
Esag. Mf



Codice	Riferimenti	Prezzo	Conf.	Off. Pubbico D.
VM1\2BN		4,24 €	10	€ 3,71 0
VM1\2FBN		3,61 €	10	€ 3,16 638



Rubinetto Botte Mm. 12 Sf.  
P/L



Codice	Riferimenti	Prezzo	Conf.	Off. Pubbico D.
RSB12	MM. 12	15,48 €	10	€ 13,55 5
RSB16	MM. 16	18,04 €	10	€ 15,78 30
RSB18	MM. 18	19,54 €	10	€ 17,10 53



Rubinetto A Sfera Doppio  
Portagomma



Codice	Riferimenti	Prezzo	Conf.	Off. Pubbico D.
2040ST015		12,83 €	10	€ 11,23 209



Rubinetto Botte Mm. 16 N° 4  
Porta Lucchetto Giallo

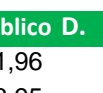

Codice	Riferimenti	Prezzo	Conf.	Off. Pubbico D.
RBL16	MM. 16	13,66 €	10	€ 11,96 5
RBL18	MM. 18	15,94 €	10	€ 13,95 8
RBL20	MM. 20	19,13 €	10	€ 16,74 3



Kronos Femm. Riparatubi  
3/8"

Codice	Riferimenti	Prezzo	Conf.	Off. Pubbico	D.
KF3\8	D.. 3/8"	6,93 €	10	€ 6,07	13
KF1\2	D.. 1/2"	8,17 €	10	€ 7,15	35
KF3\4	D.. 3/4"	11,28 €	10	€ 9,87	148
KF1	D.. 1"	13,71 €	10	€ 11,99	76



Kronos Maschio  
Riparatubi 3/8"

Codice	Riferimenti	Prezzo	Conf.	Off. Pubbico	D.
KM3\8	D.. 3/8"	6,93 €	10	€ 6,07	5
KM1\2	D.. 1/2"	8,03 €	10	€ 7,03	37
KM3\4	D.. 3/4"	11,28 €	10	€ 9,87	10
KM1	D.. 1"	12,59 €	10	€ 11,01	9



Tee Cromata Da 3/8"

Codice	Riferimenti	Prezzo	Conf.	Off. Pubbico	D.
TC3\8	D.. 3/8"	1,92 €	10	€ 1,68	180
TC1\2	D.. 1/2"	3,27 €	10	€ 2,86	521
TC3\4	D.. 3/4"	4,95 €	10	€ 4,33	98
TC1	D.. 1"	7,27 €	10	€ 6,36	125



Manicotto Cromo Da 3/8"

Codice	Riferimenti	Prezzo	Conf.	Off. Pubbico	D.
MC3\8	D.. 3/8"	1,29 €	10	€ 1,13	177
MC1\2	D.. 1/2"	1,38 €	10	€ 1,21	152
MC3\4	D.. 3/4"	2,28 €	10	€ 1,99	210
MC1	D.. 1"	3,70 €	10	€ 3,24	125



Tappo Maschio Cromo  
3/8"

Codice	Riferimenti	Prezzo	Conf.	Off. Pubbico	D.
TCM3\8	D.. 3/8"	0,72 €	10	€ 0,63	147
TCM1\2	D.. 1/2"	0,91 €	10	€ 0,80	90
TCM3\4	D.. 3/4"	1,29 €	10	€ 1,13	206
TCM1	D.. 1"	2,05 €	10	€ 1,80	225



Gomito Cromato Ff 3/8

Codice	Riferimenti	Prezzo	Conf.	Off. Pubbico	D.
GC3\8	D.. 3/8"	1,74 €	10	€ 1,52	218
GC1\2	D.. 1/2"	2,15 €	10	€ 1,88	175
GC3\4	D.. 3/4"	2,53 €	10	€ 2,21	110
GC1	D.. 1"	4,14 €	10	€ 3,62	50



Gomito Cromo 3/8" Mf Zx

Codice	Riferimenti	Prezzo	Conf.	Off. Pubbico	D.
GC3\8MF	D.. 3/8"	1,74 €	10	€ 1,52	153
GC1\2MF	D.. 1/2"	2,11 €	10	€ 1,84	110
GC3\4MF	D.. 3/4"	2,95 €	10	€ 2,58	40
GC1MF	D.. 1"	6,76 €	10	€ 5,91	55



Niplo Cromato Da 3/8"

Codice	Riferimenti	Prezzo	Conf.	Off. Pubbico	D.
NC3\8	D.. 3/8"	0,94 €	10	€ 0,82	211
NC1\2	D.. 1/2"	1,16 €	10	€ 1,02	847
NC3\4	D.. 3/4"	1,66 €	10	€ 1,45	85
NC1	D.. 1"	2,72 €	10	€ 2,38	197



Nipples Cromo Mm  
1/2"X3/8"

Codice	Riferimenti	Prezzo	Conf.	Off. Pubbico	D.
NCR1\2X3\8	1/2M X3/8M	1,51 €	10	€ 1,32	453
NCR3\4X1\2	3/4 M X1/2M	2,55 €	10	€ 2,23	924



Tappo Femmina Cromo  
Da 3/8"

Codice	Riferimenti	Prezzo	Conf.	Off. Pubbico	D.
TCF3\8	D.. 3/8"	0,83 €	10	€ 0,73	167
TCF1\2	D.. 1/2"	0,88 €	10	€ 0,77	276
TCF3\4	D.. 3/4"	1,38 €	10	€ 1,21	404
TCF1	D.. 1"	1,96 €	10	€ 1,72	250



Riduzione Cromo  
1/2"X3/8"

Codice	Riferimenti	Prezzo	Conf.	Off. Pubbico	D.
RC1\2X3\8	1/2M X3/8F	1,17 €	10	€ 1,03	1024
RC3\4X1\2	3/4M X1/2F	1,12 €	10	€ 0,98	65



Prolunga Rid. Cr. F/M  
1/2"X3/8"

Codice	Riferimenti	Prezzo	Conf.	Off. Pubbico	D.
PRC1\2X3\8	1/2F X3/8M	1,44 €	10	€ 1,26	106
PRC3\4X1\2	3/4F X1/2M	2,04 €	10	€ 1,78	4
PRC1X3\4	1F X3/4M	3,67 €	10	€ 3,21	80
PRC1X1\2	1F X1/2M	1,02 €	10	€ 0,89	0



Prolunga Ott. Cromato  
3/8"X10

Codice	Riferimenti	Prezzo	Conf.	Off. Pubbico	D.
PC3\8X10	3/8X10 mm	0,70 €	10	€ 0,61	5
PC3\8X15	3/8X15 mm	0,84 €	10	€ 0,74	11
PC3\8X20	3/8X20 mm	1,21 €	10	€ 1,06	0
PC3\8X25	3/8X25 mm	1,70 €	10	€ 1,48	0
PC3\8X30	3/8X30 mm	1,49 €	10	€ 1,31	41
PC3\8X40	3/8X40 mm	2,14 €	10	€ 1,87	0
PC3\8X50	3/8X50 mm	2,80 €	10	€ 2,45	52



Prolunga Ott. Cromato  
1/2"X10

Codice	Riferimenti	Prezzo	Conf.	Off. Pubbico	D.
PC1\2X10	1/2X10 mm	1,14 €	10	€ 1,00	165
PC1\2X15	1/2X15 mm	1,37 €	10	€ 1,20	0
PC1\2X20	1/2X20 mm	1,59 €	10	€ 1,39	909
PC1\2X25	1/2X25 mm	1,95 €	10	€ 1,70	388
PC1\2X30	1/2X30 mm	2,16 €	10	€ 1,89	0



Prolunga Ott. Cromato  
3/4"X10

Codice	Riferimenti	Prezzo	Conf.	Off. Pubbico	D.
PC3\4X10	3/4X10 mm	1,53 €	10	€ 1,34	0
PC3\4X15	3/4X15 mm	2,14 €	10	€ 1,87	0
PC3\4X20	3/4X20 mm	2,43 €	10	€ 2,12	0
PC3\4X25	3/4X25 mm	2,89 €	10	€ 2,53	0



Nipples Cromo F. 1/2"X10

Codice	Riferimenti	Prezzo	Conf.	Off. Pubbico	D.
NFC1\2X10	10 x 1/2	1,64 €	10	€ 1,44	195



Niples Maschio Bicono  
3/8"X10

Codice	Riferimenti	Prezzo	Conf.	Off. Pubbico	D.
NM3\8X10	10 x 3/8	0,89 €	10	€ 0,77	0
NMC1\2X10	10 x 1/2	1,64 €	10	€ 1,44	596



Nipples  
Esag. 1/2"X3/8"X10 C/Ro

Codice	Riferimenti	Prezzo	Conf.	Off. Pubbico	D.
NMCPD10	1/2"X(3/8"X10)	2,35 €	10	€ 2,05	0



Niples Ridotta Prolungata  
Cromata 1/2"X3/8

Codice	Riferimenti	Prezzo	Conf.	Off. Pubbico	D.
NCPRDC	1/2"X3/8"	2,16 €	10	€ 1,89	32
NCPRDD	1/2"X1/2"	1,85 €	10	€ 1,62	4131



Rame Cotto Cromato Da  
10 Mm

Codice	Riferimenti	Prezzo	Conf.	Off. Pubbico	D.
RC10	Mt. 5	5,13 €	10	€ 4,49	69,5



Raccordo Cromo 1/2" M  
"Y"Usc. F.

Codice	Riferimenti	Prezzo	Conf.	Off. Pubbico	D.
RCY12	D. 1/2"	5,75 €	10	€ 5,03	0



Gomito Saliscendi Mm  
1/2" C.Ros

Codice	Riferimenti	Prezzo	Conf.	Off. Pubbico	D.
GS12		1,87 €	10	€ 1,64	83





Raccordo Cassone A  
Piletta 1/2"



Codice	Riferimenti	Prezzo	Conf.	Off. Pubbico	D.
RCP1\2	1/2"	3,44 €	10	€ 3,01	32
RCP3\4	3/4"	4,58 €	10	€ 4,01	3
RCP1	1"	6,24 €	10	€ 5,46	37
RCP11\4	1" 1\4	7,60 €	10	€ 6,65	47



Raccordo 3 Pz Per  
Cassone 1/2"



Codice	Riferimenti	Prezzo	Conf.	Off. Pubbico	D.
R3C1\2	1/2"	4,96 €	10	€ 4,34	153
R3C3\4	3/4"	7,86 €	10	€ 6,87	203
R3C1	1"	10,83 €	10	€ 9,47	28
R3C11\4	1" 1\4	14,92 €	10	€ 13,06	40



Port. M. Giallo 1/2"X13

Codice	Riferimenti	Prezzo	Conf.	Off. Pubbico	D.
PGM1\2X13	1/2X13	1,12 €	10	€ 0,98	0
PGM3\4X20	3/4X20	1,90 €	10	€ 1,67	3
PGM1X25	1"X25	2,97 €	10	€ 2,60	25
PGM11\4X30	1"1/4X30	3,17 €	10	€ 2,78	44
PGM11\4X40	1"1/4X40	4,39 €	10	€ 3,84	7
PGM11\2X40	1"1/2X40	4,98 €	10	€ 4,36	0
PGM2X50	2"X50	6,99 €	10	€ 6,12	6



Raccordo Exlsior 1/2"X15



Codice	Riferimenti	Prezzo	Conf.	Off. Pubbico	D.
RE1\2	1/2X15	3,00 €	10	€ 2,62	104
RE3\4	3/4X20	5,35 €	10	€ 4,68	34
RE1	1"X25	8,97 €	10	€ 7,85	8
RE11\4	1"1/4X30	11,92 €	10	€ 10,43	51
RE11\2	1"1/2X40	13,26 €	10	€ 11,60	27
RE2	2"X50	19,80 €	10	€ 17,33	68



Barilotto Giallo 1/2"X4  
Cm



Codice	Riferimenti	Prezzo	Conf.	Off. Pubbico	D.
BG1\2X40	1/2"X40 mm	2,23 €	10	€ 1,95	240
BG1\2X50	1/2"X50 mm	1,84 €	10	€ 1,61	59
BG1\2X60	1/2"X60 mm	2,23 €	10	€ 1,95	90
BG1\2X70	1/2"X70 mm	2,55 €	10	€ 2,23	200
BG1\2X80	1/2"X80 mm	3,50 €	10	€ 3,06	144
BG1\2X100	1/2"X100 mm	4,90 €	10	€ 4,29	18
BG1\2X150	1/2"X150 mm	6,65 €	10	€ 5,82	73
BG1\2X200	1/2"X200 mm	9,53 €	10	€ 8,34	110
BG3\4X50	3/4"X50 mm	2,97 €	10	€ 2,60	46
BG3\4X60	3/4"X60 mm	2,97 €	10	€ 2,60	29
BG3\4X70	3/4"X70 mm	3,30 €	10	€ 2,88	101
BG3\4X80	3/4"X80 mm	3,85 €	10	€ 3,37	128
BG3\4X100	3/4"X100 mm	5,43 €	10	€ 4,75	16
BG3\4X150	3/4"X150 mm	9,28 €	10	€ 8,12	56
BG3\4X200	3/4"X200 mm	11,13 €	10	€ 9,74	100
BG1X50	1"X50 mm	3,89 €	10	€ 3,40	33
BG1X60	1"X60 mm	3,98 €	10	€ 3,48	33
BG1X70	1"X70 mm	4,57 €	10	€ 4,00	100
BG1X80	1"X80 mm	5,23 €	10	€ 4,58	25
BG1X100	1"X100 mm	9,04 €	10	€ 7,91	24
BG1X150	1"X150 mm	12,87 €	10	€ 11,26	111
BG1X200	1"X200 mm	15,66 €	10	€ 13,70	41



Tappo Maschio Con  
Rosetta 1/2"

Codice	Cod. Off.	Pz	Prezzo	Costo tot.	D.
TMCR	TMCR	1	1,83 €	€ 1,83	449
Listino	TMCRX5	5	1,73 €	€ 8,65	
	TMCRX10	10	1,64 €	€ 16,43	
	TMCRX20	20	1,56 €	€ 31,13	



Prolunga Ridotta Cromata  
11/4" F X1" M Zz Ex  
Prc11/4X1

Codice	Riferimenti	Prezzo	Off. Pubbico	D.	
PROCHBH	1" 1/4 x 1"	5,14 €	10	€ 4,49	77
PROCHDHB	1" 1/2 x 1" 1/4	5,14 €	10	€ 4,49	4



Riduzione Cromata 11/4"  
M X1" F

Codice	Riferimenti	Prezzo	Off. Pubbico	D.	
RM114100	1" 1/4 x 1"	5,14 €	10	€ 4,49	0
RM1121140	1" 1/2 x 1" 1/4	6,33 €	10	€ 5,53	0



Tubo Multistrato "373" Rivestito  
Bianco - Rosso- Blue



TM16X2EB  
TM20X2EB  
TM26X3EB  
TM32X3EB



TM16X2ER  
TM20X2ER  
TM26X3ER  
TM32X3ER

Codice	Riferimenti	Prezzo	Conf	Off. Pubbico	D.
TM16X2E	16X2X0,2	1,80 €	100	€ 1,58	4400
TM20X2E	20X2X0,2	2,07 €	100	€ 1,81	1400
TM26X3E	26X3X0,3	5,03 €	50	€ 4,40	700
TM32X3E	32X3X0,3	8,11 €	50	€ 7,09	375



Tubo Multistrato Pex 16X2



Gamma Completa

PROMO

Codice	Riferimenti	Prezzo	Conf	Off. Pubbico	D.
TM16X2	16X2X0,2	1,27 €	100	€ 1,11	14735
TM20X2	20X2X0,2	1,62 €	100	€ 1,42	6788
TM26X3	26X3X0,3	3,11 €	50	€ 2,72	4829
TM32X3	32X3X0,3	4,55 €	50	€ 3,98	1560



Collettore Inclinato 2 Vie

Codice	Riferimenti	Prezzo	Conf.	Off. Pubbico	D.
CI2A	2 vie	9,36 €	10	€ 8,19	304
CI3A	3 vie	14,04 €	10	€ 12,29	336
CI4A	4 vie	18,71 €	10	€ 16,37	173
CI5A	5 vie	21,33 €	10	€ 18,66	300



Tubo Mult. Gas Riv. 16X2

Codice	Riferimenti	Prezzo	Conf	Off. Pubbico	D.
TM16X2G	16X2X0,3	3,03 €	100	€ 2,65	100
TM20X2G	20X2X0,4	4,01 €	100	€ 3,51	0
TM26X3G	26X3X0,6	7,49 €	50	€ 6,55	927



Collettore Icma  
Ang.Usc.1/2"

Codice	Riferimenti	Prezzo	Conf.	Off. Pubbico	D.
C1\2I2	2 vie	14,41 €	10	€ 12,61	529
C1\2I3	3 vie	21,61 €	10	€ 18,91	490
C1\2I4	4 vie	28,81 €	10	€ 25,21	402

Refrigerazione



Tubo Multistrato  
Pexb/Al/Pexb  
Rivestimento Certificato

Codice	Riferimenti	Prezzo	Conf	Off. Pubbico	D.
TM16X2EF	16X2-Isolante 13	2,46 €	99	€ 2,16	1300
TM20X2EF	20X2-Isolante 13	2,91 €	100	€ 2,55	4800
TM26X3EF	26X3-Isolante 13	5,18 €	50	€ 4,53	1400
TM32X3EF	32X3-Isolante 13	9,08 €	50	€ 7,95	650



Collettore MF 3/4" Uscita  
D. 1/2"

Codice	Riferimenti	Prezzo	Conf.	Off. Pubbico	D.
CS2V3\4X1\2	2 vie	5,82 €	10	€ 5,09	143
CS3V3\4X1\2	3 vie	8,73 €	10	€ 7,64	187
CS4V3\4X1\2	4 vie	11,64 €	10	€ 10,18	114



Raccordo Retto Quick  
1/2"X16 B.

Codice	Riferimenti	Prezzo	Conf.	Off. Pubbico	D.
RQ16B	D. 16	1,49 €	10	€ 1,31	1787
RQ20R	D. 20	2,28 €	10	€ 1,99	251

Collettore MF 1" Uscita D. 1/2"

Codice	Riferimenti	Prezzo	Conf.	Off. Pubbico	D.
CS2V1X1\2	2 vie	9,65 €	10	€ 8,45	88
CS3V1X1\2	3 vie	12,61 €	10	€ 11,03	44
CS4V1X1\2	4 vie	15,15 €	10	€ 13,26	24



Cassette per Collettori  
Modello Unico

Codice	Riferimenti	Prezzo	Conf.	Off. Pubbico	D.
CS2V11\4X1\2	2 vie	13,12 €	10	€ 11,48	11
CS3V11\4X1\2	3 vie	18,79 €	10	€ 16,44	10
CS4V11\4X1\2	4 vie	24,48 €	10	€ 21,42	10

Codice	Riferimenti	Prezzo	Conf.	Off. Pubbico	D.
C3024	300X240X80	14,97 €	10	€ 13,10	66
C4024	400X240X80	17,70 €	10	€ 15,48	118
C5024	500X240X80	20,42 €	10	€ 17,87	80
C6024	600X240X80	21,78 €	10	€ 19,06	28



Niplo Maschio Mult.  
1/2"X16X2,0

Codice	Riferimenti	Prezzo	Conf.	Off. Pubbico	D.
NM1\2X16M	1/2"x16	1,85 €	10	€ 1,62	1355
NM1\2X20M	1/2"x20	3,37 €	10	€ 2,95	211
NM3\4X16M	3/4"x16	3,07 €	10	€ 2,69	530
NM3\4X20M	3/4"x20	3,40 €	10	€ 2,97	110



Niplo F. Nich.  
Mult.1/2"X16X2,0

Codice	Riferimenti	Prezzo	Conf.	Off. Pubbico	D.
NF1\2X16M	1/2"x16	2,26 €	10	€ 1,98	1715
NF1\2X20M	1/2"x20	3,32 €	10	€ 2,90	150
NF3\4X16M	3/4"x16	2,53 €	10	€ 2,21	577
NF3\4X20M	3/4"x20	4,07 €	10	€ 3,56	264



Niples Doppia 16  
Multistrato

Codice	Riferimenti	Prezzo	Conf.	Off. Pubbico	D.
ND16M	16x16	2,98 €	10	€ 2,61	2220
ND20M	20x20	4,14 €	10	€ 3,63	255
ND26M	26x26	6,07 €	10	€ 5,31	224
ND32M	32x32	15,38 €	10	€ 13,46	175



Gomito Doppio 16  
Multistrato

Codice	Riferimenti	Prezzo	Conf.	Off. Pubbico	D.
GD16M	16x16	3,34 €	10	€ 2,93	1918
GD20M	20x20	5,43 €	10	€ 4,75	1315
GD26M	26x26	8,25 €	10	€ 7,22	223
GD32M	32x32	14,21 €	10	€ 12,43	104

Gomito F. 1/2"X16 Mult. "



Codice	Riferimenti	Prezzo	Conf.	Off. Pubbico	D.
GF1\2X16M	1/2"x16	2,60 €	10	€ 2,28	3226
GF1\2X20M	1/2"x20	4,12 €	10	€ 3,60	462
GF3\4X16M	3/4"x16	3,51 €	10	€ 3,07	822
GF3\4X20M	3/4"x20	4,69 €	10	€ 4,10	485

Gomito Maschio 1/2"X16  
Mult.,



Codice	Riferimenti	Prezzo	Conf.	Off. Pubbico	D.
GM1\2X16M	1/2"x16	2,64 €	10	€ 2,31	189
GM1\2X20M	1/2"x20	4,03 €	10	€ 3,53	416
GM3\4X16M	3/4"x16	2,61 €	10	€ 2,29	601
GM3\4X20M	3/4"x20	4,62 €	10	€ 4,04	463

Tee Tre Vie Multistrato  
16X2



Codice	Riferimenti	Prezzo	Conf.	Off. Pubbico	D.
T16M	16x16	4,95 €	10	€ 4,33	227
T20M	20x20	5,81 €	10	€ 5,08	219
T26M	26x26	11,87 €	10	€ 10,39	225
T32M	32x32	15,51 €	10	€ 13,57	167

Inserti X Multistrato Da  
16X2



Codice	Riferimenti	Prezzo	Conf.	Off. Pubbico	D.
I16M	16x1/2	1,42 €	10	€ 1,24	4170

Gomito Flangiato 1/2"X16  
Mult



Codice	Riferimenti	Prezzo	Conf.	Off. Pubbico	D.
GFL1\2X16M	1/2"x16	3,42 €	10	€ 2,99	1993
GFL1\2X20M	1/2"x20	5,32 €	10	€ 4,66	427

Tee Femmina Multistrato  
D. 16X1/2"X16X2,0



Codice	Riferimenti	Prezzo	Conf.	Off. Pubbico	D.
TF1\2X16M	16x1/2x16	4,12 €	10	€ 3,61	316
TF1\2X20M	20x1/2x20	6,21 €	10	€ 5,43	331
TF3\4X20M	20x3/4x20	7,03 €	10	€ 6,15	336
TF3\4X26M	26x3/4x26	10,94 €	10	€ 9,57	331





Niplo Maschio  
1/2"X16Press.

Codice	Riferimenti	Prezzo	Conf.	Off. Pubbico	D.
NM1\2X16MP	1/2"x16	2,33 €	10	€ 2,04	712
NM1\2X20MP	1/2"x20	2,99 €	10	€ 2,61	452
NM3\4X16MP	3/4"x16	2,85 €	10	€ 2,49	358
NM3\4X20MP	3/4"x20	3,91 €	10	€ 3,42	457



Niples F. 1/2"X16 M.  
Press.

Codice	Riferimenti	Prezzo	Conf.	Off. Pubbico	D.
NF1\2X16MP	1/2"x16	2,07 €	10	€ 1,81	683
NF1\2X20MP	1/2"x20	1,71 €	10	€ 1,50	478
NF3\4X16MP	3/4"x16	2,73 €	10	€ 2,39	560
NF3\4X20MP	3/4"x20	3,30 €	10	€ 2,89	206

Niplo Doppio 16 Press.



Codice	Riferimenti	Prezzo	Conf.	Off. Pubbico	D.
ND16MP	16x16	1,89 €	10	€ 1,65	339
ND20MP	20x20	2,29 €	10	€ 2,00	224
ND26MP	26x26	3,94 €	10	€ 3,45	211
ND32MP	32x32	5,82 €	10	€ 5,10	219



Gomito Doppio D. 16  
M.Press.

Codice	Riferimenti	Prezzo	Conf.	Off. Pubbico	D.
GD16MP	16x16	1,71 €	10	€ 1,50	687
GD20MP	20x20	2,98 €	10	€ 2,61	132
GD26MP	26x26	9,51 €	10	€ 8,32	182
GD32MP	32x32	11,64 €	10	€ 10,18	216

Gomito Multist.Pinz.  
1/2"X16



Codice	Riferimenti	Prezzo	Conf.	Off. Pubbico	D.
GF1\2X16MP	1/2"x16	2,59 €	10	€ 2,27	466
GF1\2X20MP	1/2"x20	3,35 €	10	€ 2,93	256
GF3\4X16MP	3/4"x16	3,52 €	10	€ 3,08	210
GF3\4X20MP	3/4"x20	4,41 €	10	€ 3,86	227



Gomito M. 1/2"X16 M.  
Press.

Codice	Riferimenti	Prezzo	Conf.	Off. Pubbico	D.
GM1\2X16MP	1/2"x16	3,08 €	10	€ 2,70	370
GM1\2X20MP	1/2"x20	3,29 €	10	€ 2,88	380
GM3\4X16MP	3/4"x16	3,42 €	10	€ 2,99	210
GM3\4X20MP	3/4"x20	4,31 €	10	€ 3,77	331

Tee D. 16 Mul. Pinsare



Codice	Riferimenti	Prezzo	Conf.	Off. Pubbico	D.
T16MP	16x16	3,08 €	10	€ 2,69	537
T20MP	20x20	4,69 €	10	€ 4,11	643
T26MP	26x26	8,23 €	10	€ 7,20	308
T32MP	32x32	9,65 €	10	€ 8,44	223



Niples F. 1/2"X16 Gir. Mp

Codice	Riferimenti	Prezzo	Conf.	Off. Pubbico	D.
NF1\2X16GMP	1/2"x16	5,46 €	10	€ 4,77	288
NF3\4X16GMP	1/2"x20	6,09 €	10	€ 5,32	0

Gomito Flang.1/2"X16  
Mul.Pre.



Codice	Riferimenti	Prezzo	Conf.	Off. Pubbico	D.
GFL1\2X16MP	1/2"x16	3,12 €	10	€ 2,73	245
GFL1\2X20MP	1/2"x20	3,61 €	10	€ 3,16	359



Tee F. 1/2"X16 Mul.  
Press.

Codice	Riferimenti	Prezzo	Conf.	Off. Pubbico	D.
TF1\2X16MP	16x1/2x16	4,74 €	10	€ 4,15	398
TF1\2X20MP	20x1/2x20	5,04 €	10	€ 4,41	405
TF3\4X20MP	20x3/4x20	6,12 €	10	€ 5,36	347
TF3\4X26MP	26x3/4x26	7,99 €	10	€ 6,99	248



Nipples M 1/2"X16 Mult. Gas

Codice	Riferimenti	Prezzo	Conf.	Off. Pubbico	D.
NM1\2X16MPG	1/2"x16	3,06 €	10	€ 2,68	288
NM1\2X20MPG	1/2"x20	3,67 €	10	€ 3,21	572
	3/4"x16		10		
NM3\4X20MPG	3/4"x20	4,13 €	10	€ 3,62	123



Nipples F. 1/2"X16 Mult. Gas

Codice	Riferimenti	Prezzo	Conf.	Off. Pubbico	D.
NF1\2X16MPG	1/2"x16	2,54 €	10	€ 2,23	370
NF1\2X20MPG	1/2"x20	3,21 €	10	€ 2,81	434
	3/4"x16		10		
NF3\4X20MPG	3/4"x20	3,21 €	10	€ 2,81	106



Nipples Doppio Mult. Gas 16X18

Codice	Riferimenti	Prezzo	Conf.	Off. Pubbico	D.
ND16MPG	16x16	3,47 €	10	€ 3,04	465
ND20MPG	20x20	4,85 €	10	€ 4,25	393
ND26MPG	26x26	7,03 €	10	€ 6,15	413
	32x32		10		



Gomito Doppio 16 Mult. Gas

Codice	Riferimenti	Prezzo	Conf.	Off. Pubbico	D.
GD16MPG	16x16	3,43 €	10	€ 3,00	277
GD20MPG	20x20	5,51 €	10	€ 4,83	527
GD26MPG	26x26	7,16 €	10	€ 6,26	177
	32x32		10		



Gomito F. 1/2"X16 Mult. Gas

Codice	Riferimenti	Prezzo	Conf.	Off. Pubbico	D.
GF1\2X16MPG	1/2"x16	4,09 €	10	€ 3,58	1847
GF1\2X20MPG	1/2"x20	3,85 €	10	€ 3,37	98
	3/4"x16		10		
GF3\4X20MPG	3/4"x20	4,23 €	10	€ 3,70	167



Gomito M. 1/2"X16 Mult. Gas

Codice	Riferimenti	Prezzo	Conf.	Off. Pubbico	D.
GM1\2X16MPG	1/2"x16	3,09 €	10	€ 2,71	472
GM1\2X20MPG	1/2"x20	4,02 €	10	€ 3,51	278
	3/4"x16		10		
GM3\4X20MPG	3/4"x20	4,44 €	10	€ 3,89	220



Tee 16 Mult. Gas

Codice	Riferimenti	Prezzo	Conf.	Off. Pubbico	D.
T16MPG	16x16	5,93 €	10	€ 5,19	744
T20MPG	20x20	7,79 €	10	€ 6,82	590
T26MPG	26x26	12,08 €	10	€ 10,57	80



Nipples F. 1/2"X16 Gir. Mpg

Codice	Riferimenti	Prezzo	Conf.	Off. Pubbico	D.
NF1\2X16GMPG	1/2"x16	7,35 €	10	€ 6,44	238
NF3\4X16GMPG	1/2"x20	7,73 €	10	€ 6,76	120



Gomito Flang. F. 1/2"X16 Mpg

Codice	Riferimenti	Prezzo	Conf.	Off. Pubbico	D.
GFL1\2X16MPG	1/2"x16	4,91 €	10	€ 4,30	101
GFL1\2X20MPG	1/2"x20	5,31 €	10	€ 4,65	10



Tee F. 1/2"X16 Mult/ Gas

Codice	Riferimenti	Prezzo	Conf.	Off. Pubbico	D.
TF1\2X16MPG	16x1/2x16	5,11 €	10	€ 4,47	220
TF1\2X20MPG	20x1/2x20	6,63 €	10	€ 5,80	389
TF3\4X20MPG	20x3/4x20	7,51 €	10	€ 6,58	130
TF3\4X26MPG	26x3/4x26	10,64 €	10	€ 9,31	400

Gomito Zincato Da 1/2" Mf  
Fig.92

Visualizza la gamma completa

Codice	Riferimenti	Prezzo	Conf.	Off. Pubbico	D.
GZ1\2MF	D. 1/2"	0,68 €	10	€ 0,60	335
GZ3\4MF	D. 3/4"	1,38 €	10	€ 1,20	1724
GZ1MF	D. 1"	1,94 €	10	€ 1,70	218
GZ11\4MF	D. 1 1/4"	3,33 €	10	€ 2,92	168

Gomito Zincato Da 1/2"  
Fig. 90

Visualizza la gamma completa

Codice	Riferimenti	Prezzo	Conf.	Off. Pubbico	D.
GZ1\2	D. 1/2"	0,76 €	10	€ 0,66	3
GZ3\4	D. 3/4"	1,38 €	10	€ 1,20	331
GZ1	D. 1"	2,09 €	10	€ 1,83	575
GZ11\4	D. 1 1/4"	3,63 €	10	€ 3,18	145

Tee Zincato Da 1/2" Fig.  
130

Visualizza la gamma completa

Codice	Riferimenti	Prezzo	Conf.	Off. Pubbico	D.
TZ1\2	D. 1/2"	1,02 €	10	€ 0,89	310
TZ3\4	D. 3/4"	1,76 €	10	€ 1,54	984
TZ1	D. 1"	2,00 €	10	€ 1,75	366
TZ11\4	D. 1 1/4"	3,86 €	10	€ 3,38	109

Manicotto Zingato Da 1/2"  
F.270

Visualizza la gamma completa

Codice	Riferimenti	Prezzo	Conf.	Off. Pubbico	D.
MZ1\2	D. 1/2"	0,87 €	10	€ 0,76	0
MZ3\4	D. 3/4"	1,18 €	10	€ 1,04	88
MZ1	D. 1"	1,57 €	10	€ 1,37	229
MZ11\4	D. 1 1/4"	2,46 €	10	€ 2,16	308

Niples Zincato Da 1/2"  
Fig.280

Visualizza la gamma completa

Codice	Riferimenti	Prezzo	Conf.	Off. Pubbico	D.
NZ1\2	D. 1/2"	0,58 €	10	€ 0,51	104
NZ3\4	D. 3/4"	1,00 €	10	€ 0,88	100
NZ1	D. 1"	1,46 €	10	€ 1,28	648
NZ11\4	D. 1 1/4"	2,63 €	10	€ 2,30	356

Tappo Maschio Zinc. Da  
1/2"

Visualizza la gamma completa

Codice	Riferimenti	Prezzo	Conf.	Off. Pubbico	D.
TZM1\2	D. 1/2"	0,60 €	10	€ 0,52	16
TZM3\4	D. 3/4"	0,61 €	10	€ 0,54	58
TZM1	D. 1"	0,67 €	10	€ 0,59	67
TZM11\4	D. 1 1/4"	1,24 €	10	€ 1,08	139

Rac. 3 Pz Conico Zincato  
1/2"

Visualizza la gamma completa

Codice	Riferimenti	Prezzo	Conf.	Off. Pubbico	D.
BZ1\2	D. 1/2"	2,91 €	10	€ 2,54	407
BZ3\4	D. 3/4"	3,29 €	10	€ 2,88	101
BZ1	D. 1"	4,30 €	10	€ 3,76	136
BZ11\4	D. 1 1/4"	6,53 €	10	€ 5,72	55

Riduzione Zincata  
3/4"X1/2" Mf

Visualizza la gamma completa

Codice	Riferimenti	Prezzo	Conf.	Off. Pubbico	D.
RZ3\4X1\2	3/4"x1/2"	0,82 €	10	€ 0,72	38
RZ1X1\2	1"x1/2"	1,15 €	10	€ 1,01	0
RZ1X3\4	1"x3/4"	0,84 €	10	€ 0,73	17
RZ11\4X1\2	1"1/4x1/2"	1,99 €	10	€ 1,74	139

Collare Pesante Da  
Cpt1/2"

Codice	Riferimenti	Prezzo	Conf.	Off. Pubbico	D.
CPT1\2	D.1/2"	0,58 €	10	€ 0,51	1248
CPT3\4	D.3/4"	0,62 €	10	€ 0,54	302
CPT1	D.1"	0,64 €	10	€ 0,56	564
CPT11\4	D.1"1/4"	0,68 €	10	€ 0,59	186
CPT11\2	D.1"1/2"	0,72 €	10	€ 0,63	388
CPT2	D.2"	0,82 €	10	€ 0,72	638

Tubo Zincato Saldati Ec.  
Da 1/2"

Codice	Riferimenti	Prezzo	Conf.	Off. Pubbico	D.
TZ1\2E	D. 1/2"	34,73 €	10	€ 30,39	291
TZ3\4E	D. 3/4"	42,63 €	10	€ 37,30	670
TZ1E	D. 1"	61,45 €	10	€ 53,77	158
TZ11\4E	D. 1 1/4"	78,82 €	10	€ 68,97	142
TZ11\2E	D.1"1/2"	83,47 €	10	€ 73,04	81
TZ2E	D.2"	113,82 €	10	€ 99,59	180





Gomito Zinc. 3 V. 1/2" F. 221

[Visualizza la gamma completa](#)

Codice	Riferimenti	Prezzo	Conf.	Off. Pubbico	D.
GZ3V1\2	D. 1/2"	2,47 €	10	€ 2,16	0
GZ3V3\4	D. 3/4"	3,95 €	10	€ 3,46	0
GZ3V1	D. 1"	5,22 €	10	€ 4,56	0
GZ3V11\4	D. 1 1/4"	9,25 €	10	€ 8,09	0



Tappo Femmina Zinc. 1/2" F. 300

[Visualizza la gamma completa](#)

Codice	Riferimenti	Prezzo	Conf.	Off. Pubbico	D.
TZF1\2	D. 1/2"	0,98 €	10	€ 0,86	750
TZF3\4	D. 3/4"	0,88 €	10	€ 0,77	95
TZF1	D. 1"	1,04 €	10	€ 0,91	100
TZF11\4	D. 1 1/4"	1,56 €	10	€ 1,36	0



Barilotto Zincato 1/2"X10 Cm

[Visualizza la gamma completa](#)

Codice	Riferimenti	Prezzo	Conf.	Off. Pubbico	D.
BZ1\2X100	1/2"X100mm	1,41 €	10	€ 1,23	121
BZ1\2X150	1/2"X150mm	1,88 €	10	€ 1,65	247
BZ1\2X200	1/2"X200mm	1,29 €	10	€ 1,12	0
BZ1\2X250	1/2"X250mm	1,63 €	10	€ 1,42	32
BZ1\2X300	1/2"X300mm	1,77 €	10	€ 1,55	37
BZ1\2X400	1/2"X400mm	4,83 €	10	€ 4,22	497
BZ1\2X500	1/2"X500mm	5,77 €	10	€ 5,05	51
BZ1\2X1000	1/2"X1000mm	11,13 €	10	€ 9,74	74

Barilotto Zincato 3/4"X10 Cm

Codice	Riferimenti	Prezzo	Conf.	Off. Pubbico	D.
BZ3\4X100	3/4"X100mm	0,94 €	10	€ 0,83	38
BZ3\4X150	3/4"X150mm	1,23 €	10	€ 1,08	2
BZ3\4X200	3/4"X200mm	1,47 €	10	€ 1,28	1
BZ3\4X250	3/4"X250mm	1,82 €	10	€ 1,59	4
BZ3\4X300	3/4"X300mm	2,15 €	10	€ 1,88	0
BZ3\4X400	3/4"X400mm	6,04 €	10	€ 5,29	220
BZ3\4X500	3/4"X500mm	7,18 €	10	€ 6,28	169
BZ3\4X1000	3/4"X1000mm	6,88 €	10	€ 6,02	0

Barilotto Zincato 1"X10 Cm.

Codice	Riferimenti	Prezzo	Conf.	Off. Pubbico	D.
BZ1X100	1"X100mm	1,16 €	10	€ 1,02	5
BZ1X150	1"X150mm	1,64 €	10	€ 1,44	0
BZ1X200	1"X200mm	2,93 €	10	€ 2,57	0
BZ1X250	1"X250mm	2,73 €	10	€ 2,39	15
BZ1X300	1"X300mm	3,26 €	10	€ 2,86	6
BZ1X400	1"X400mm	7,60 €	10	€ 6,65	77
BZ1X500	1"X500mm	7,83 €	10	€ 6,85	48
BZ1X1000	1"X1000mm	10,22 €	10	€ 8,94	61

Barilotto Zincato 1 1/4"X10 Cm.

Codice	Riferimenti	Prezzo	Conf.	Off. Pubbico	D.
BZ11\4X100	1 1/4"X100mm	1,62 €	10	€ 1,42	16
BZ11\4X150	1 1/4"X150mm	2,18 €	10	€ 1,90	4
BZ11\4X200	1 1/4"X200mm	3,87 €	10	€ 3,38	30
BZ11\4X250	1 1/4"X250mm	3,64 €	10	€ 3,19	0
BZ11\4X300	1 1/4"X300mm	4,20 €	10	€ 3,68	13
BZ11\4X400	1 1/4"X400mm	5,84 €	10	€ 5,11	0
BZ11\4X500	1 1/4"X500mm	6,73 €	10	€ 5,89	0

Tee Zincata 4 Vie F. 223 D.1/2"



[Visualizza la gamma completa](#)

Codice	Riferimenti	Prezzo	Conf.	Off. Pubbico	D.
TZ4V1\2	D. 1/2"	3,44 €	10	€ 3,01	0
TZ4V3\4	D. 3/4"	4,30 €	10	€ 3,76	0
TZ4V1	D. 1"	6,35 €	10	€ 5,56	0

Croce Zincata Fig. 180 Da 1/2"



[Visualizza la gamma completa](#)

Codice	Riferimenti	Prezzo	Conf.	Off. Pubbico	D.
CZ1\2	D. 1/2"	2,63 €	10	€ 2,30	0
CZ3\4	D. 3/4"	3,95 €	10	€ 3,45	0
CZ1	D. 1"	4,88 €	10	€ 4,27	0
CZ11\4	D. 1 1/4"	6,55 €	10	€ 5,73	0

Barilotto Zincato Cm. 1/2"X15 Prolungato " Scorrevole "



[Visualizza la gamma completa](#)

Codice	Riferimenti	Prezzo	Conf.	Off. Pubbico	D.
BZ1\2X150P	1/2"X150mm	1,21 €	10	€ 1,06	0
BZ1\2X200P	1/2"X200mm	1,57 €	10	€ 1,37	0
BZ3\4X150P	3/4"X150mm	1,57 €	10	€ 1,37	0
BZ3\4X200P	3/4"X200mm	1,59 €	10	€ 1,39	0
BZ1X150P	1"X150mm	2,13 €	10	€ 1,86	0
BZ1X200P	1"X200mm	2,88 €	10	€ 2,52	0
BZ11\4X150P	1 1/4"X150mm	2,96 €	10	€ 2,59	0
BZ11\4X200P	1 1/4"X200mm	3,82 €	10	€ 3,34	0
BZ11\2X150P	1 1/2"X150mm	3,44 €	10	€ 3,01	0
BZ11\2X200P	1 1/2"X200mm	4,55 €	10	€ 3,99	0
BZ2X150P	2"X150mm	4,83 €	10	€ 4,23	0
BZ2X200P	2"X200mm	6,02 €	10	€ 5,27	0



Nuovo Tubo Gas Rivestito

Codice	Riferimenti	Prezzo	Conf.	Off. Pubbico	D.
EMITEG100	cm.100	12,15 €	10	€ 10,63	106
EMITEG150	cm.150	17,33 €	10	€ 15,17	228
EMITEG200	cm.200	21,00 €	10	€ 18,38	70
EMITEG300	cm.300	34,66 €	10	€ 30,33	51



Tubo Gas Estensibile Autoestinguente

Codice	Riferimenti	Prezzo	Conf.	Off. Pubbico	D.
TGAS20E	D. 20	0,73 €	10	€ 0,64	775
TGAS25E	D. 25	0,81 €	10	€ 0,71	995
TGAS30E	D. 30	0,98 €	10	€ 0,86	1200
TGAS40E	D. 40	1,59 €	10	€ 1,39	400



Valvola Gas Farfalla 1/2" Mf

Codice	Riferimenti	Prezzo	Conf.	Off. Pubbico	D.
VSG1\2FMF	D. 1/2"	8,01 €	10	€ 7,01	252
VSG3\4FMF	D. 3/4"	11,85 €	10	€ 10,37	154
VSG1FMF	D. 1"	18,39 €	10	€ 16,09	113



Valvola Sfera Gas 1/2" Far. Bug

Codice	Riferimenti	Prezzo	Conf.	Off. Pubbico	D.
VSG1\2F	D. 1/2"	7,63 €	10	€ 6,68	171
VSG3\4F	D. 3/4"	11,51 €	10	€ 10,07	105
VSG1F	D. 1"	13,54 €	10	€ 11,84	6



Valvola Gas 1/2" Farfalla Presa Pressione

Codice	Riferimenti	Prezzo	Conf.	Off. Pubbico	D.
VSG1\2FPPP	D. 1/2"	16,25 €	10	€ 14,22	0
VSG3\4FPPP	D. 3/4"	23,32 €	10	€ 20,41	142
VSG1FPPP	D. 1"	33,09 €	10	€ 28,95	49



Valvola A Sfera Gas 1/2" Piatta

Codice	Riferimenti	Prezzo	Conf.	Off. Pubbico	D.
VSG1\2P	D. 1/2"	7,63 €	10	€ 6,68	83
VSG3\4P	D. 3/4"	11,51 €	10	€ 10,07	310
VSG1P	D. 1"	18,39 €	10	€ 16,09	145



Flex Acqua Mf Da 1/2" 110/210

Codice	Riferimenti	Prezzo	Conf.	Off. Pubbico	D.
FA1\220	1/2" 10<>20	5,24 €	10	€ 4,58	900
FA1\240	1/2" 20<>40	6,20 €	10	€ 5,42	26
FA3\420	3/4" 10<>20	7,29 €	10	€ 6,38	1482
FA3\440	3/4" 20<>40	9,24 €	10	€ 8,08	89



Flex Gas Estensibile Gas D. 1/2" 100<>200

Codice	Riferimenti	Prezzo	Conf.	Off. Pubbico	D.
FG1\220	1/2" 10<>20	6,27 €	10	€ 5,49	783
FG1\240	1/2" 20<>40	7,29 €	10	€ 6,38	44
FG3\420	3/4" 10<>20	8,70 €	10	€ 7,62	1493
FG3\440	3/4" 20<>40	10,58 €	10	€ 9,26	977



Rubinetto Gas Sq. Mm. 1/2"



Codice	Riferimenti	Prezzo	Conf.	Off. Pubbico	D.
RGSMM	D. 1/2"	7,59 €	10	€ 6,64	316



Valvola Gas 1/2" Mf Piatta Bu

Codice	Riferimenti	Prezzo	Conf.	Off. Pubbico	D.
VSG1\2PMF	D. 1/2"	7,63 €	10	€ 6,68	9
VSG3\4PMF	D. 3/4"	11,51 €	10	€ 10,07	0
VSG1PMF	D. 1"	18,39 €	10	€ 16,09	142



Minicentralina Per 2 Bombole  
Modello Y + Reg Bp 4Kg Con  
Manometro E Riduttori Di 1° E  
2° Stadio (Completa Di Staffa E  
Tasselli) Con Membrana In  
Viton + Fless

Codice	Riferimenti	Prezzo	Conf.	Off. Pubbico	D.
MC230212F	2 vie 4 KG	73,38 €	10	€ 64,20	43



Riduttore Primo Stadio In  
Alluminio Per Serbatoi Gpl  
Interrati E Fuori Terra Ad Uso  
Domestico Ed Industriale  
Portata 40-60 Kg/H  
C/Manometro P.E. 16 Bar Max  
1/4" F - 3/8" F (P.U.= 1-3 Bar)

Codice	Riferimenti	Prezzo	Conf.	Off. Pubbico	D.
RGAP40M	40-60 kg	50,60 €	10	€ 44,28	101



Riduttore Pressione 12-14  
Kg/H

Codice	Riferimenti	Prezzo	Conf.	Off. Pubbico	D.
RGAP14M	14 kg	25,81 €	10	€ 22,58	49



Regolatore Gas Alta  
Pressione Pesante

Codice	Riferimenti	Prezzo	Conf.	Off. Pubbico	D.
AP02100XZ		52,63 €	10	€ 46,05	6



Regolatore 7Kg. Bp F.3/8"

Codice	Riferimenti	Prezzo	Conf.	Off. Pubbico	D.
RG7C	7 kg	18,22 €	10	€ 15,94	46
RG10C	10 kg	19,23 €	10	€ 16,83	6



Regolatore Bassa Press.  
Variab

Codice	Riferimenti	Prezzo	Conf.	Off. Pubbico	D.
RGBPV	bp	3,88 €	10	€ 3,39	354



Tubo Pvc X Gas Bombole  
Gpl 8X13 Imq rotolo Mt.  
50

Codice	Riferimenti	Prezzo	Conf.	Off. Pubbico	D.
TGGPL	D. 13x8	1,13 €	10	€ 0,99	2032



Minicentralina Gas 2 V.  
Reg. 4 Kg. Con Flessibili

Codice	Riferimenti	Prezzo	Conf.	Off. Pubbico	D.
MCG24F	2 vie	39,22 €	10	€ 34,32	9



Riduttore Primo Stadio In Alluminio  
Per Serbatoi Gpl Interrati E Fuori  
Terra Ad Uso Domestico Ed  
Industriale Portata 40-60 Kg/H  
S/Manometro  
P.E. 16 Bar Max 1/4" F - 3/8" F  
(P.U.= 1-3 Bar)

Codice	Riferimenti	Prezzo	Conf.	Off. Pubbico	D.
RGAP40	40-60 kg	43,77 €	10	€ 38,30	50



Regolatore Alta Pressione

Codice	Riferimenti	Prezzo	Conf.	Off. Pubbico	D.
RGAP		8,10 €	10	€ 7,08	438



Ridutt. Aprn 40 Kg. 0 /3  
Bar Con Manometro

Codice	Riferimenti	Prezzo	Conf.	Off. Pubbico	D.
RAP40M	40 kg	50,60 €	10	€ 44,28	23



Regolatore Gas 4 Kg  
Entrata Dado Ch25 Uscita  
G 3/8 F

Codice	Riferimenti	Prezzo	Conf.	Off. Pubbico	D.
RG4CD	4 kg	9,87 €	10	€ 8,63	160



Regolatore Gas Bassa  
Pressione

Codice	Riferimenti	Prezzo	Conf.	Off. Pubbico	D.
RGBP	bp	5,44 €	10	€ 4,76	196



Tubo Pvc X Gas Metano  
13X20 Imq rotolo Mt. 50

Codice	Riferimenti	Prezzo	Conf.	Off. Pubbico	D.
TGM	D. 20x13	1,87 €	10	€ 1,64	463





Gomito M. 1/2" X Gpl

Codice	Riferimenti	Prezzo	Conf.	Off. Pubbico	D.
GM1\2G	Gpl	2,13 €	10	€ 1,86	137



Gomito M. 1/2" X Met.

Codice	Riferimenti	Prezzo	Conf.	Off. Pubbico	D.
GM1\2M	Metano	2,55 €	10	€ 2,23	180



Niples Femmina 1/2"X10  
Gpl

Codice	Riferimenti	Prezzo	Conf.	Off. Pubbico	D.
NF1\2G	Gpl	1,41 €	10	€ 1,23	361



Niples Maschio 1/2"X10  
Gpl

Codice	Riferimenti	Prezzo	Conf.	Off. Pubbico	D.
NM1\2G		1,26 €	10	€ 1,10	337



Raccordo A Gomito G 1/2"  
M-M

Codice	Riferimenti	Prezzo	Conf.	Off. Pubbico	D.
RG110001	1/2"	1,67 €	10	€ 1,46	3



Niples Gialla 1/2" Ds Ds

Codice	Riferimenti	Prezzo	Conf.	Off. Pubbico	D.
NG1\2DD	1/2" Dx-Dx	1,87 €	10	€ 1,64	391
NG1\2DS	1/2" Dx-Sx	4,43 €	10	€ 3,87	814



Port. A 90° - Ø 14 Metano  
Con Filetto Maschio, In Zama  
G 1/2" M 1/8" F

Codice	Riferimenti	Prezzo	Conf.	Off. Pubbico	D.
PG911406	1/2"	1,77 €	10	€ 1,55	100



Gomito F. 1/2" X Gpl

Codice	Riferimenti	Prezzo	Conf.	Off. Pubbico	D.
GF1\2G	Gpl	1,91 €	10	€ 1,67	138



Gomito F. 1/2" X Met.

Codice	Riferimenti	Prezzo	Conf.	Off. Pubbico	D.
GF1\2M	Metano	2,23 €	10	€ 1,95	182



Niples Femmina 1/2"X14  
Met

Codice	Riferimenti	Prezzo	Conf.	Off. Pubbico	D.
NF1\2M	Metano	1,36 €	10	€ 1,19	65



Niples Maschio 1/2"X14  
Met

Codice	Riferimenti	Prezzo	Conf.	Off. Pubbico	D.
NM1\2M		1,32 €	10	€ 1,15	565



Raccordo A Gomito G  
1/2" M-F Port. A 90° - Ø  
14 Metano Con Filetto  
Maschio, In Zama

Codice	Riferimenti	Prezzo	Conf.	Off. Pubbico	D.
RG100001	1/2"	1,72 €	10	€ 1,51	21



Raccordo A "Y" Metano

Codice	Riferimenti	Prezzo	Conf.	Off. Pubbico	D.
RYMET	Metano	3,80 €	10	€ 3,32	198
RYGPL	Gpl	0,96 €	10	€ 0,84	3119



Raccordo M.1/4" Dado Mm  
25

Codice	Riferimenti	Prezzo	Conf.	Off. Pubbico	D.
147.010		2,45 €	10	€ 2,15	12



Elettropompe In Ghisa  
Periferica Hp. 0,5

Codice	Cod. Off.	Pz	Prezzo	Costo tot.	D.
PMF050	PMF050	1	83,96 €	€ 83,96	179
	PMF050x5	5	78,08 €	€ 390,40	



Elettropompe Multistadio  
In Ghisa Arven-Gvp V220

Codice	Riferimenti	Prezzo	Conf. Off. Pubbico	D.
GPVRGM0600	0,60	164,75 €	10	€ 144,15 99
GPVRGM0750	0,75	178,92 €	10	€ 156,56 10
GPVRGM1000	1,00	220,75 €	10	€ 193,15 181



Elettropompe  
Autodescante Ghisa  
Monogirante Hp. 0,8

Codice	Cod. Off.	Pz	Prezzo	Costo tot.	D.
GPIJTG0800AR	GPIJTG0800AR	1	195,51 €	€ 195,51	42
	GPIJTG0800ARx5	5	181,83 €	€ 909,14	



Elettropompa  
Multicellulare  
Autodescante Sistema  
Venturi Hp. 0,6

Codice	Cod. Off.	Pz	Prezzo	Costo tot.	D.
GPIRMA0600AR	GPIRMA0600AR	1	209,32 €	€ 209,32	40
	GPIRMA0600ARx2	5	194,66 €	€ 973,32	



Elettropompe  
Autodescante Ghisa  
Monogirante Hp. 1

Codice	Cod. Off.	Pz	Prezzo	Costo tot.	D.
GPIJTG1000AR	GPIJTG1000AR	1	195,51 €	€ 195,51	22
	GPIJTG1000ARx5	5	181,83 €	€ 909,14	



Elettropompa  
Multicellulare  
Autodescante Sistema  
Venturi Hp. 0,9

Codice	Cod. Off.	Pz	Prezzo	Costo tot.	D.
GPIRMA0900/AR	GPIRMA0900/AR	1	234,62 €	€ 234,62	56
	GPIRMA0900/ARx2	5	218,19 €	€1.090,97	



Gruppo Pressurizzazione  
Pressost. Digitali N. 2 Rb  
150M

Codice	Riferimenti	Prezzo	Conf. Off. Pubbico	D.
PD2-RB150M		2.059,57 €	10	€1.802,13 2



Elettropompa  
Multicellulare  
Autodescante Sistema  
Venturi Hp. 1,2

Codice	Cod. Off.	Pz	Prezzo	Costo tot.	D.
GPIRMA1200AR	GPIRMA1200AR	1	265,67 €	€ 265,67	6
	GPIRMA1200ARx2	5	247,07 €	€1.235,36	



Gruppo Pressurizzazione  
Pressost. Digitali N. 2 Rb  
200M

Codice	Riferimenti	Prezzo	Conf. Off. Pubbico	D.
PD2-RB200M		2.182,29 €	10	€1.909,50 1



Elettropompa  
Multicellulare  
Autodescante Sistema  
Venturi Hp. 1,6

Codice	Cod. Off.	Pz	Prezzo	Costo tot.	D.
GPIRMA1600AR	GPIRMA1600AR	1	319,72 €	€ 319,72	14
	GPIRMA1600ARx2	2	303,74 €	€ 607,48	



Elettropompa  
Autodescante In Ghisa  
Hp. 075

Codice	Cod. Off.	Pz	Prezzo	Costo tot.	D.
MDM0750	MDM0750	1	240,37 €	€ 240,37	36
	MDM0750X2	2	223,54 €	€ 447,08	



Elettropompa  
Autodescante In Ghisa  
Hp. 1

Codice	Cod. Off.	Pz	Prezzo	Costo tot.	D.
MDM1000	MDM1000	1	265,67 €	€ 265,67	36
	MDM1000X2	2	247,07 €	€ 494,15	



Elettropompe  
Sommergibili Monoblocco  
Multistadio Verticali, Per  
Pozzi 4" Hp 1.5 230 Hz50  
Mt. 20H 05Vvf-Aut+C.B.

**MONDIALJET 4"**

RED.MON1500/CB	1" 1/4	1,5	230	50 l/min	90 mt.
RED.MON1600/CB	1" 1/4	1,5	230	90 l/min	70 mt.

Codice	Riferimenti	Prezzo	Conf.	Off. Pubbico	D.
MJET150M	Hp. 1,5	433,75 €	10	€ 379,53	20
MJET160M	Hp. 1,5	438,70 €	10	€ 383,87	1



ST  
motore  
+  
idraulica  
4"

Pompe Sommerse Per  
P O Z Z I Da 4 " Hp.  
1,00

Codice	Riferimenti	Prezzo	Conf.	Off. Pubbico	D.
ST-13-21T	HP 2 Trifase	438,70 €	10	€ 383,87	3
ST-13-16T	HP 1,5 Trifase	379,22 €	10	€ 331,82	3
ST-13-11M	HP 1,0 Mono	374,26 €	10	€ 327,48	8



Elettropompe Centrifughe  
Bigiranti

Codice	Riferimenti	Prezzo	Conf.	Off. Pubbico	D.
RBT1500	Hp. 1,5	351,95 €	10	€ 307,96	5
RBT2000	Hp. 2,0	386,65 €	10	€ 338,32	5
RBT3000	Hp. 3,0	401,53 €	10	€ 351,33	6
RBT4000	Hp. 4,0	773,31 €	10	€ 676,64	5



ARVEN POMPA  
SOMM.ACQUE CHIARE  
MULTIGIR.  
ROXY 5"

Codice	Riferimenti	Prezzo	Conf.	Off. Pubbico	D.
RXY0800	Hp. 0,8	340,80 €	10	€ 298,20	0
RXY1000	Hp. 1,0	394,09 €	10	€ 344,83	2
RXY1200	Hp. 1,2	431,27 €	10	€ 377,36	0
RXY1600	Hp. 1,8	495,71 €	10	€ 433,75	0

Elettropompe Autodescante Inox  
Monogirante Hp. 1



Codice	Prezzo	Hp	Off. Pubbico
GPVJTX0810	164,82 €	1	144,22 €

Tiger 200F Dn50 Con Galleggiante Tri  
2Hp 380V 50Hz 10 M H07Rnf



Codice	Prezzo	Rif.	Off. Pubbico
TGR2005F	852,70 €		746,11 €
TGR3005F	1.365,19 €		1.194,54 €

Maxima-S 100 Aut Mono 1Hp 230V 50Hz  
6Mt H0 7Rnf



MAXIMA-S



Codice	Prezzo	Rif.	Off. Pubbico
VXS1000	203,89 €		178,40 €

Tiger-R 80 Con Galleggiante 0,8Hp 230V  
50Hz 5Mt H07Rn



Codice	Prezzo	Hp	Off. Pubbico
TGR0800	279,41 €	0,8	244,48 €
TGR0900	310,96 €	1	272,09 €

Turbo J Man Mono 1Hp 230V 50Hz Con  
Control Box



Codice	Prezzo	Hp	Off. Pubbico
GPVTBJ1003CB	348,12 €	1	304,61 €
TBJ1803CB	441,63 €	1,8	386,42 €

Elettropompa 1Hp 230V 50Hz Q max 225  
l/min H max 8mt



Codice	Prezzo	Rif.	Off. Pubbico
VXX0752	143,76 €		125,79 €

Cutter 200 Man Tri 2Hp 380V 50Hz 10Mt  
H0 7Rnf



Codice	Prezzo	Hp	Off. Pubbico
TRC2005	1.417,83 €		1.240,60 €
TRC3005	1.563,27 €		1.367,86 €

REX 120-E MONO 1,2KW 230V 50Hz con  
automatismo e marcia a secco incorporato



si consiglia il montaggio  
di una sfera in uscita  
i litri secondo il vostro  
impianto



Codice	Prezzo	Hp	Off. Pubbico
RHP1202/E	302,38 €	1,2	264,59 €

REX 120 AUT MONO 1,2KW 230V 50Hz  
Con galleggiante elettrico



si consiglia il montaggio  
di una sfera in uscita  
i litri secondo il vostro  
impianto



Codice	Prezzo	Hp	Off. Pubbico
RHP1202	247,86 €	1,2	216,87 €





Lowara Genyo 8A/F22  
Sistema Di Comando Pr  
Elettropompe 109120180

Codice	Riferimenti	Prezzo	Off. Pubbico	D.
GENYO8A/F22	Hp. 0,33	76,39 €	€ 38,19	1



Kit Di Pressione Espa  
Flussostato Regolabile  
Max 10 Bar 416 Std

Codice	Riferimenti	Prezzo	Off. Pubbico	D.
KIT01		48,46 €	€ 24,23	5

Elettropompa "PAL" è sistema automatico:



**Elettropompa periferica autoadescente, Completa:** vaso di espansione, pressostato, sensore di flusso, valvola di non ritorno, filtro. si avvia e si arresta automaticamente al momento dell'apertura e chiusura del rubinetto.  
> PROTEZIONE MARCIA A SECCO  
È dotata di un controllo di flusso che arresta automaticamente la pompa in mancanza di acqua dopo 6 minuti. Successivamente farà 4 tentativi ad intervalli di 1-5-12-24 ore, avviandosi automaticamente per 2 minuti > PROTEZIONE ANTIGRIPPAGGIO  
In caso di mancato utilizzo si avvia automaticamente ogni 72 ore per un tempo di 8

Codice	Riferimenti	Prezzo	Pz	Off. Pubbico	D.
PAL0800	Hp. 0,8	183,41 €	10	€ 160,49	1
PAL1000	Hp. 1	195,81 €	10	€ 171,33	13
PAL1500	Hp. 1,5	381,70 €	10	€ 333,98	4



Contenitore 3 Pz 9/34"  
vetro trasparente per  
acqua



Codice	Riferimenti	Prezzo	Pz	Off. Pubbico	D.
C3G10	D. 3/4"	20,37 €	10	€ 17,82	99
C3H10	D. 1"	23,28 €	10	€ 20,37	49



Cartuccia F/Avvolto 9/34"  
20Mc Nastro Al Cotone

Codice	Riferimenti	Prezzo	Pz	Off. Pubbico	D.
CFA1020	Nastro Cotone	3,64 €	10	€ 3,19	314
CCA1020	Carboni	16,83 €	10	€ 14,72	96
CRL10250	Autopulente	9,71 €	10	€ 8,50	124
CSM1020	Sali Minerali	30,54 €	10	€ 26,72	126



Candeletta Sondina 1/2"  
Molpen

Codice	Riferimenti	Prezzo	Off. Pubbico	D.
CS1\2		5,82 €	€ 2,91	84



3 Mt  
5 Mt  
7 Mt  
Elettro. Immersione  
3Mt

Codice	Riferimenti	Prezzo	Pz	Off. Pubbico	D.
GEI03	mt. 03	14,68 €	10	€ 12,84	60
GEI05	mt. 05	18,72 €	10	€ 16,38	50
GEI07	mt. 07	23,28 €	10	€ 20,37	570



**COELBO**

PRESS CONTROL  
REGOLABILE 0-5 BAR (3HP)  
CON FLUSSOSTATO



Codice	Riferimenti	Prezzo	Conf.	Off. Pubbico	D.
PRESHYD		40,38 €	10	€ 35,33	119



**COELBO**

Pressostato Elettronico regolazione  
digitale funzionamento 1 pompa o  
modello per 2 pompe



Guarda Video

← Swth1

Swth2 →



Codice	Riferimenti	Prezzo	Conf.	Off. Pubbico	D.
0789SWITCH100	1 Pompa	66,92 €	10	€ 58,56	11
0789SWITCH200	2 Pompe	89,23 €	10	€ 78,07	10



Compact E Slim ESL

• Alimentazione 230V 50 Hz  
• Pres. min 2 bar - max 6 bar-5÷50° C

Addolcitore cabinato in due modelli dalle dimensioni compatte. con valvola automatica elettronica a rigenerazione volume/tempo con salamoia e bombola in materiale composito con liner, in PE rivestito in fibra di vetro e resina epossidica in un unico corpo.  
Completo di by-pass. Accessori: disinfezione automatica  
resine (coD. NCSAL05) installata direttamente sulla valvola, tubo di scarico in PVC e valvola di sicurezza pozzetto salamoia con galleggiante (coD.RF09959).  
VALVOLE RUNXIN

- Ampio display LCD retroilluminato
- Adotta testate ermetiche ceramica alto grado
- Sistema per controllo di flussi affidabile
- Indicazione di mancata alimentazione elettrica
- Blocco pulsanti in assenza di operazioni un minuto
- Miscelatore di durezza integrato

Codice	Riferimenti	Prezzo	Pz	Off. Pubbico	D.
NCCVE12ENJRBP	12 ENJRBP	658,42 €	10	€ 576,11	8
NCCVE12ESLRBP	12 ESLRBP	676,93 €	10	€ 592,32	7
NCCVE18ESLRBP	18 ESLRBP	740,20 €	10	€ 647,68	0
NCCVE28ESLRBP	28 ESLRBP	1.088,44 €	10	€ 952,39	5
NCBTE70E268BP	70 E268BP	1.889,93 €	10	€1.653,69	4



Elettropompa Autoadescante



Codice	Riferimenti	Prezzo	Off. Pubbico	D.
SP5	Hp. 0,75	244,85 €	€ 214,24	93
SP7	Hp. 1	271,26 €	€ 237,35	86



Elettropompe Periferica  
0,3 Kw 0,4 Hp

Codice	Riferimenti	Prezzo	Off. Pubbico	D.
PM16	Hp. 0,4	76,79 €	€ 67,19	167





Elettropompe Centrifuga Autoadescante 0,75 Kw 1Hp

Codice	Riferimenti	Prezzo	Off. Pubbico	D.
BGM7	Hp. 0,75	193,58 €	€ 169,39	0



Elettropompa Drenaggio Acque Sporche E Chiare  
0,25 Kw 0,33 Hp

Codice	Riferimenti	Prezzo	Off. Pubbico	D.
DOC3	Hp. 0,33	177,77 €	€ 155,55	10
DOC7	Hp. 0,75	231,92 €	€ 202,93	11



Elettropompa Drenaggio Acque Sporche E Chiare  
0,55 Kw 0,75 Hp

Codice	Riferimenti	Prezzo	Off. Pubbico	D.
DOMO7VX	Hp. 0,33	308,23 €	€ 269,70	12
DOMO10VX	Hp. 0,75	382,97 €	€ 335,10	9

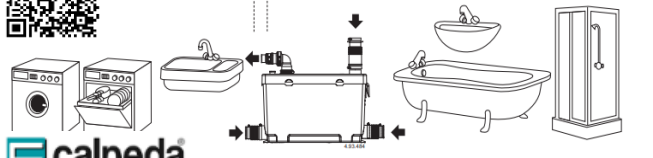
calpeda

SOLO ATTACCHI SANITARI NO WC

Codice	Riferimenti	Prezzo	Off. Pubbico	D.
GEOCLEAN		782,84 €	€ 684,98	1



Elettropompe Centrifughe Con Bocche Filetate In Acciaio Inox



Codice	Riferimenti	Prezzo	Off. Pubbico	D.
CAM70/45	Hp. 1,2	345,14 €	€ 302,00	25
CAM70/33	Hp. 1	273,66 €	€ 239,45	25





Elettropompe Centrifuga Autoadescante 0,55 Kw 0,75Hp

Codice	Riferimenti	Prezzo	Off. Pubbico	D.
BGM5	Hp. 0,75	174,20 €	€ 152,43	0



Elettropompe Multistadio E Multigrante 0,5 Kw 0,75 Hp

Codice	Riferimenti	Prezzo	Off. Pubbico	D.
3HM04P05M	Hp. 0,5	214,39 €	€ 187,60	21
3HM03P05M	Hp. 0,75	198,90 €	€ 174,04	25
3HM05P07M	Hp. 1	283,62 €	€ 248,17	32

Elettropompa Sommersa 5" Con Galleggiante 0,55 Kw 0,75 Hp

Codice	Riferimenti	Prezzo	Off. Pubbico	D.
3SC4/05/5CG	Hp. 1	450,25 €	€ 393,97	0

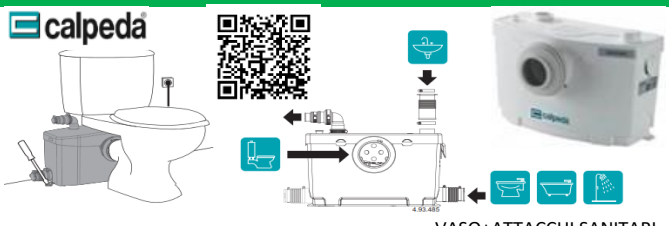

calpeda

VASO+ATTACCHI SANITARI

Codice	Riferimenti	Prezzo	Off. Pubbico	D.
GEOCOMP		815,38 €	€ 713,46	9

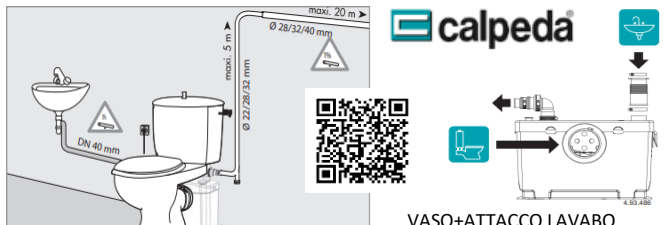

calpeda

VASO+ATTACCO LAVABO

Codice	Riferimenti	Prezzo	Off. Pubbico	D.
GEOTRIT		741,68 €	€ 648,97	2



Pompa Calpeda Ngxm 2/80



Codice	Riferimenti	Prezzo	Pz	Off. Pubbico	D.
NGXM2		184,81 €	10	€ 161,71	7
NGXM3		210,67 €	10	€ 184,34	2
NGXM4		231,22 €	10	€ 202,32	0



Elettropompa centrifughe Serie NMD Calpeda



Codice	Riferimenti	Prezzo	Pz	Off. Pubbico	D.
NMDM20110A	HP. 1,00	337,39 €	10	€ 295,21	3
NMDM20140B	HP. 1,50	511,09 €	10	€ 447,21	5
NMDM20140AE	HP. 2,00	637,02 €	10	€ 557,39	8
NMD25190CB	HP. 3,00	1.029,72 €	10	€ 901,01	2
NMD25190BA	HP. 4,00	1.144,14 €	10	€1.001,12	2
NMD25190AB	HP. 5,5	1.398,96 €	10	€1.224,09	0



Pompa Calpeda Ctm 61



Codice	Riferimenti	Prezzo	Pz	Off. Pubbico	D.
CTM61		141,27 €	10	€ 123,61	9



Elettropompe Multistadio funzionamento silenzioso



Codice	Riferimenti	Prezzo	Pz	Off. Pubbico	D.
MGPM203	HP. 0,60	229,31 €	10	€ 200,65	17
MGPM204	HP. 0,75	260,81 €	10	€ 228,21	19
MGPM205	HP. 1,00	304,54 €	10	€ 266,47	9



Sistema di pressurizzazione autoadescente a velocità variabile.



META è una soluzione plug and play, la pompa è dotata di sensore di pressione, valvola di non ritorno e un serbatoio a membrana integrati.  
L'elettronica comanda in modo automatico l'avviamento lo spegnimento e consente di mantenere la pressione costante.

Codice	Riferimenti	Prezzo	Off. Pubbico	D.	
META		912,49 €	10	€ 798,43	2



Sistema di pressurizzazione autoadescente a velocità variabile.



META è una soluzione plug and play, la pompa è dotata di sensore di pressione, valvola di non ritorno e un serbatoio a membrana integrati.  
L'elettronica comanda in modo automatico l'avviamento lo spegnimento e consente di mantenere la pressione costante.

Codice	Riferimenti	Prezzo	Pz	Off. Pubbico	D.
METASMALL		770,29 €	10	€ 674,00	5



Elettropompa autoscendente Serie NGL Calpeda



Codice	Riferimenti	Prezzo	Pz	Off. Pubbico	D.
NGLM2		199,07 €	10	€ 174,18	0
NGLM3		214,61 €	10	€ 187,79	0
NGLM4		230,18 €	10	€ 201,41	0



Elettropompa Serie CAM Autoscendente Calpeda



Codice	Riferimenti	Prezzo	Pz	Off. Pubbico	D.
CAM80E		258,14 €	10	€ 225,87	65
CAM90A		301,73 €	10	€ 264,01	53
CAM91A		318,92 €	10	€ 279,06	3



Elettropompa autoscendente corpo inox Serie MXPM



Codice	Riferimenti	Prezzo	Pz	Off. Pubbico	D.
MXPM203		237,38 €	10	€ 207,71	1
MXPM204		267,60 €	10	€ 234,15	8
MXPM205		335,52 €	10	€ 293,58	6
MXPM404		348,04 €	10	€ 304,54	11
MXPM405		416,66 €	10	€ 364,58	8



Pompa Sommergibile In Acciaio Inox



Codice	Riferimenti	Prezzo	Pz	Off. Pubbico	D.
GXRM9	Hp. 0,33	300,06 €	10	€ 262,55	2
GXRM11	Hp. 0,5	324,46 €	10	€ 283,90	0
GXRM13	Hp. 0,6	388,17 €	10	€ 339,65	2



Elettropompa Calpeda Sommergibile GQSM 40-9 V.230/50



Codice	Riferimenti	Prezzo	Off. Pubbico	D.	
GQSM230		399,58 €	10	€ 349,63	5



Pompe centrifughe multistadio sommergibili con camicia in acciaio inossidabile, bocca di mandata verticale e valvola di non ritorno in aspirazione.  
Capacità di aspirare acqua fino a 1 millimetro



Codice	Riferimenti	Prezzo	Pz	Off. Pubbico	D.
GXMZERO		274,99 €	10	€ 240,62	5





Presscontrol Riparte 2,2 Bar

**Codice** PSD02 544

Presscontrol Riparte 1,5 Bar

**Codice** PSD01 493

**PROMO**

Codice	Cod. Off.	Pz	Prezzo	Costo tot.	D.
PSD02	PSD02	1	31,63 €	€ 31,63	544
<b>Listino</b>	PSD02X6	6	30,68 €	€ 184,07	
39,38 €	PSD02X12	12	30,05 €	€ 360,55	
	PSD02X24	24	29,41 €	€ 705,92	



Galleggiante Inglese Tipo Sicilia In Ottone D. 1/2"

**Sfere ordinare a parte**

Codice	Riferimenti	Prezzo	Pz	Off. Pubbico	D.
GI1/2N	D. 1/2"	8,35 €	10	€ 7,31	1887
GI3/4N	D. 3/4"	8,86 €	10	€ 7,75	1933
GI1N	D. 1"	9,43 €	10	€ 8,25	10



Galleggiante 5 Copp.Pes. D. 3/8"

**Sfere ordinare a parte**

Codice	Riferimenti	Prezzo	Pz	Off. Pubbico	D.
G5C3/8	D. 3/8"	7,29 €	10	€ 6,38	116
G5C1/2	D. 1/2"	11,31 €	10	€ 9,90	76
G5C3/4P	D. 3/4"	13,66 €	10	€ 11,96	33
G5C1	D. 1"	14,93 €	10	€ 13,06	34
G5C11/4	D. 1 1/4"	31,02 €	10	€ 27,14	29
G5C11/2	D. 1 1/2"	61,74 €	10	€ 54,02	35
G5C2	D. 2"	35,68 €	10	€ 31,22	12



Sfera Staffa & Base Da 24 Lt

Codice	Riferimenti	Prezzo	Pz	Off. Pubbico	D.
SS24C	Lt. 24	34,61 €	10	€ 30,29	0



Sfera Inox Da 24 Lt. Att. Al

Codice	Riferimenti	Prezzo	Pz	Off. Pubbico	D.
SI24	Lt. 24	159,86 €	10	€ 139,88	9

Sfera Lt.24 Norme Ce

Membrane autoclave Ricambio Visualizza la gamma



Visualizza la gamma completa

Codice	Cod. Off.	Pz	Prezzo	Costo tot.	D.
S24C	S24C	5	32,22 €	€ 161,11	1064
	S24C24	24	30,61 €	€ 734,64	

Codice	Riferimenti	Prezzo	Pz	Off. Pubbico	D.
MIA25LE	Membrana 24	4,05 €	10	€ 3,54	636

Alimentatore Luise Aria per Polmone Autoclave



Codice	Riferimenti	Prezzo	Pz	Off. Pubbico	D.
MINI	100-500	46,83 €	10	€ 40,97	309
MIDI	200-2000	95,82 €	5	€ 83,85	57
MAXI	1000-4000	96,66 €	2	€ 84,58	1
SMAXI	200-2000	98,37 €	1	€ 86,08	128
VRA	Valvolina	4,81 €	10	€ 4,21	10

Alimentatore Amis Aria per Polmone Autoclave



Codice	Riferimenti	Prezzo	Pz	Off. Pubbico	D.
A750	24-750	32,49 €	10	€ 28,43	45
A2000	1000-2000	38,56 €	5	€ 33,74	11



Flex Alimentatore Luise Mini M.1/4" X F.1/2" Cm 70

Codice	Riferimenti	Prezzo	Pz	Off. Pubbico	D.
FABD700	Mini	6,83 €	10	€ 5,98	14
FADG1000	Midi	15,94 €	10	€ 13,95	25

Niples Forata per Flessibile Alimentatore



Scopri tutti gli articoli di categoria con Qr

Codice	Riferimenti	Prezzo	Pz	Off. Pubbico	D.
NF1X1/4	1" - 1/4"	3,34 €	10	€ 2,92	981
NF11/4X1/2	1 1/4 - 1/2"	5,04 €	10	€ 4,41	782

Sistema di Pressione con Regolazione del minimo Max pressione 10 Bar



Codice	Riferimenti	Prezzo	Pz	Off. Pubbico	D.
KIT05	KIT05	85,57 €	10	€ 74,87	88



Pressostato per pompa acqua da 1,4 -2,8 Bar

Codice	Cod. Off.	Pz	Prezzo	Costo tot.	D.
PC2	PC2	1	6,96 €	€ 6,96	133
	PC210	10	6,61 €	€ 66,10	



Pressostati Square D 1,4-4,6



**PROMO**

Codice	Cod. Off.	Pz	Prezzo	Costo tot.	D.
FSG-2	FSG-2	1	19,74 €	€ 19,74	1730
	FSG-2X25	25	18,75 €	€ 468,72	



Indicatore Livello X Liquidi 5 Funzioni Senza Supporto

Codice	Riferimenti	Prezzo	Conf.	Off. Pubbico	D.
ILL008		50,13 €	10	€ 43,86	159



Sonda A Scalare In Acciaio 5 Posizioni + Massa

Codice	Riferimenti	Prezzo	Conf.	Off. Pubbico	D.
SAS009		15,34 €	10	€ 13,42	1



Laterale



Radiale

Manometro 1/4" Attacco Dietro posteriore

Codice	Riferimenti	Prezzo	Conf.	Off. Pubbico	D.
MABR010	Lat.. D. 1/4"	5,11 €	10	€ 4,47	339
MAB010	RaD. D.1/4"	4,55 €	10	€ 3,99	406



Centralina Prelievo Acqua

Codice	Riferimenti	Prezzo	Conf.	Off. Pubbico	D.
CCAA	HP. 1	130,64 €	10	€ 114,31	51
CCAAS	HP. 1,5	197,51 €	10	€ 172,82	10



Contatore Asciutto Getto Unico Completo Coperchio & Raccordi

**PROMO**

Gamma Completa



Codice	Riferimenti	Prezzo	Conf.	Off. Pubbico	D.
CAUD	D. 1/2"	30,39 €	10	€ 26,59	2624
CAUG	D. 3/4"	32,66 €	10	€ 28,58	228
CAUH	D. 1"	43,34 €	10	€ 37,92	1211



Pressostato Calpeda 1,4 - 2,8 Bar

Codice	Cod. Off.	Pz	Prezzo	Costo tot.	D.
PMAT5M	PMAT5M	1	12,39 €	€ 12,39	409
	PMAT5M10	10	11,77 €	€ 117,68	



Condensatore 10 Uf D/Faston Zz

Codice	Riferimenti	Prezzo	Conf.	Off. Pubbico	D.
C10MF	c/faston	2,28 €	10	€ 2,00	37
C12,5MF	c/faston	4,40 €	10	€ 3,85	136
C16MF	c/faston	4,61 €	10	€ 4,03	157
C20MF	c/faston	5,09 €	10	€ 4,45	107
C25MF	c/faston	6,44 €	10	€ 5,63	38
C30MF	c/faston	6,76 €	10	€ 5,91	114
C40MF	c/faston	7,84 €	10	€ 6,86	118
C50MF	c/faston	10,68 €	10	€ 9,34	52
CDICB12,5	c/faston	4,40 €	10	€ 3,85	34
CDICB16	c/faston	4,61 €	10	€ 4,03	0
CDICB20	c/faston	5,09 €	10	€ 4,45	0



Raccordo 5 Vie 1" per autoclave

Codice	Riferimenti	Prezzo	Conf.	Off. Pubbico	D.
R1A90M	D. 1" cm. 9	4,78 €	10	€ 4,18	1601
R1A110	D. 1" cm. 11	5,37 €	10	€ 4,70	63



Indicatore 7 Livello Inc. 503

Codice	Riferimenti	Prezzo	Conf.	Off. Pubbico	D.
ILL503		47,29 €	10	€ 41,38	4



Contatore Getto Multiplo Completo Coperchio & Raccordi Ideale per portate acque maggiori

Codice	Riferimenti	Prezzo	Conf.	Off. Pubbico	D.
CAMD	D. 1/2"	33,22 €	10	€ 29,07	378
CAMG	D. 3/4"	39,85 €	10	€ 34,87	399
CAMH	D. 1"	60,12 €	10	€ 52,60	549
CAMHB	D. 1 1/4"	83,62 €	10	€ 73,17	58



Mix Jose' Bidet  
Cromo



Codice	Cod. Off.	Pz	Prezzo	Costo tot.	D.
MBJE00	MBJE00	1	52,37 €	€ 52,37	57
<b>Listino</b>	MBJE00X5	5	49,61 €	€ 248,06	
55,13 €	MBJE00X10	10	47,13 €	€ 471,32	
	MBJE00X15	15	44,65 €	€ 669,77	



Mix Jose' Lavabo  
Cromo



Codice	Cod. Off.	Pz	Prezzo	Costo tot.	D.
MLJE00	MLJE00	1	52,37 €	€ 52,37	1
<b>Listino</b>	MLJE00X5	5	49,61 €	€ 248,06	
55,13 €	MLJE00X10	10	47,13 €	€ 471,32	
	MLJE00X15	15	44,65 €	€ 669,77	



Mix Bidet Jose'  
Bronzo



Codice	Cod. Off.	Pz	Prezzo	Costo tot.	D.
MBJE47	MBJE47	1	64,34 €	€ 64,34	2
<b>Listino</b>	MBJE47X5	5	60,95 €	€ 304,76	
67,73 €	MBJE47X10	10	57,90 €	€ 579,05	
	MBJE47X15	15	54,86 €	€ 822,86	



Mix Lavabo Jose'  
Bronzo



Codice	Cod. Off.	Pz	Prezzo	Costo tot.	D.
MLJE47	MLJE47	1	64,34 €	€ 64,34	7
<b>Listino</b>	MLJE47X5	5	60,95 €	€ 304,76	
67,73 €	MLJE47X10	10	57,90 €	€ 579,05	
	MLJE47X15	15	54,86 €	€ 822,86	



Mix Doccia Incasso  
Bronzo Jose



Codice	Cod. Off.	Pz	Prezzo	Costo tot.	D.
MDIJE47	MDIJE47	1	47,88 €	€ 47,88	26
<b>Listino</b>	MDIJE47X5	5	45,36 €	€ 226,80	
50,40 €	MDIJE47X10	10	43,09 €	€ 430,92	
	MDIJE47X15	15	40,82 €	€ 612,36	



Mix Vasca Jose'  
Bronzo



Codice	Cod. Off.	Pz	Prezzo	Costo tot.	D.
MVJE47	MVJE47	1	83,79 €	€ 83,79	26
<b>Listino</b>	MVJE47X5	5	79,38 €	€ 396,90	
88,20 €	MVJE47X10	10	75,41 €	€ 754,11	
	MVJE47X15	15	71,44 €	€1.071,63	



Mix Doccia Esterno  
Jose' Bronzo



Codice	Cod. Off.	Pz	Prezzo	Costo tot.	D.
MDEJ47	MDEJ47	1	83,79 €	€ 83,79	16
<b>Listino</b>	MDEJ47X5	5	79,38 €	€ 396,90	
88,20 €	MDEJ47X10	10	75,41 €	€ 754,11	
	MDEJ47X15	15	71,44 €	€1.071,63	



Mix Lavello Monof.  
C/Bassa Jose'  
Bronzo



Codice	Cod. Off.	Pz	Prezzo	Costo tot.	D.
MLMJ47	MLMJ47	1	58,17 €	€ 58,17	2
<b>Listino</b>	MLMJ47X5	5	55,11 €	€ 275,56	
61,24 €	MLMJ47X10	10	52,36 €	€ 523,57	
	MLMJ47X15	15	49,60 €	€ 744,02	



ZIPRONI  
LA QUALITÀ È LO STILE

Mix Lavabo Kristal  
C/Scarico



Codice	Cod. Off.	Pz	Prezzo	Costo tot.	D.
KR303CR11KZ	KR303CR11KZ	1	49,08 €	€ 49,08	226
<b>Listino</b>	KR303CR11KZX5	5	46,49 €	€ 232,47	
51,66 €	KR303CR11KZX10	10	44,17 €	€ 441,69	
	KR303CR11KZX15	15	41,84 €	€ 627,67	



ZIPRONI  
LA QUALITÀ È LO STILE

Mix Bidet Kristal  
C/Scarico



Codice	Cod. Off.	Pz	Prezzo	Costo tot.	D.
KR403CR11KZ	KR403CR11KZ	1	49,08 €	€ 49,08	209
<b>Listino</b>	KR403CR11KZX5	5	46,49 €	€ 232,47	
51,66 €	KR403CR11KZX10	10	44,17 €	€ 441,69	
	KR403CR11KZX15	15	41,84 €	€ 627,67	





**ZIPPONI**  
L'ALTERNATIVA LOBBISTILE

Mix Incasso Doccia  
Kristol



Codice	Cod. Off.	Pz	Prezzo	Costo tot.	D.
KR002CR00KZ	KR002CR00KZ	1	38,60 €	€ 38,60	151
<b>Listino</b>	KR002CR00KZX5	5	36,57 €	€ 182,86	
40,64 €	KR002CR00KZX10	10	34,74 €	€ 347,43	
	KR002CR00KZX15	15	32,91 €	€ 493,72	



Mix Lavabo Con  
Scar. 1" Cartuccia D.  
40



**SPHERA**  
DOCCE & ACCESSORI

Codice	Cod. Off.	Pz	Prezzo	Costo tot.	D.
MLDE00	MLDE00	1	43,06 €	€ 43,06	301
<b>Listino</b>	MLDE00X5	5	40,80 €	€ 203,98	
45,33 €	MLDE00X10	10	38,76 €	€ 387,56	
	MLDE00X15	15	36,72 €	€ 550,74	



Mix Debora Doccia  
Incasso C.40



**SPHERA**  
DOCCE & ACCESSORI

Codice	Cod. Off.	Pz	Prezzo	Costo tot.	D.
MDIDE00	MDIDE00	1	30,25 €	€ 30,25	109
<b>Listino</b>	MDIDE00X5	5	28,66 €	€ 143,31	
31,85 €	MDIDE00X10	10	27,23 €	€ 272,29	
	MDIDE00X15	15	25,80 €	€ 386,93	



Mix Doccia Esteno  
Debora



**SPHERA**  
DOCCE & ACCESSORI

Codice	Riferimenti	Prezzo	Off. Pubbico	D.
MDEDE00	Cromo	35,01 €	5	€ 30,64 306
MDEDE00				



Miscelatore Bidet Serie Nx



**by GAY**  
rubinetterie

Codice	Riferimenti	Prezzo	Off. Pubbico	D.
MXBIMCNXCCR	Cromo	72,61 €	5	€ 63,53 25
MXBIMCNXCCR				



**ZIPPONI**  
L'ALTERNATIVA LOBBISTILE

Mix Vasca Kristal  
C/Dot.Doc.



Codice	Cod. Off.	Pz	Prezzo	Costo tot.	D.
KR103CR54KZ	KR103CR54KZ	1	82,29 €	€ 82,29	5
<b>Listino</b>	KR103CR54KZX5	5	77,96 €	€ 389,81	
86,63 €	KR103CR54KZX10	10	74,06 €	€ 740,64	
	KR103CR54KZX15	15	70,17 €	€ 1.052,49	



Mix Debora Bidet  
Con Scar. 1"



**SPHERA**  
DOCCE & ACCESSORI

Codice	Cod. Off.	Pz	Prezzo	Costo tot.	D.
MBDE00	MBDE00	1	43,06 €	€ 43,06	378
<b>Listino</b>	MBDE00X5	5	40,80 €	€ 203,98	
45,33 €	MBDE00X10	10	38,76 €	€ 387,56	
	MBDE00X15	15	36,72 €	€ 550,74	



Mix Vasca Debora  
Ec. C /Dupl.



**SPHERA**  
DOCCE & ACCESSORI

Codice	Cod. Off.	Pz	Prezzo	Costo tot.	D.
MVDE00	MVDE00	1	56,50 €	€ 56,50	263
<b>Listino</b>	MVDE00X5	5	53,52 €	€ 267,62	
59,47 €	MVDE00X10	10	50,85 €	€ 508,49	
	MVDE00X15	15	48,17 €	€ 722,58	



Miscelatore Vasca  
Completo Di Doccia Flex  
E Supporto Serie Nx



**by GAY**  
rubinetterie

Codice	Riferimenti	Prezzo	Off. Pubbico	D.
MXVAMCNXCCR	Cromo	86,18 €	5	€ 75,41 3
MXVAMCNXCCR				



Miscelatore Lavabo Serie  
Nx



**by GAY**  
rubinetterie

Codice	Riferimenti	Prezzo	Off. Pubbico	D.
MXLAMCNXCCR	Cromo	72,61 €	5	€ 63,53 32
MXLAMCNXCCR				



Miscelatore Doccia Incasso Con Deviatore Serie Nx Piastra Quadra



Codice	Riferimenti	Prezzo	Pz	Off. Pubbico	D.
MXDDMCNXQCR	Cromo	84,73 €	5	€ 74,14	0
MXDDMCNXQCR					

## SERIE MAIA







Mix Incasso Doccia Maia

Codice	Riferimenti	Prezzo	Pz	Off. Pubbico	D.
FO001CR00FZ	Cromo	53,89 €	5	€ 47,16	7



## SERIE MAIA

Fonte Bidet 3/8 C/Scar Cr Maia

Codice	Riferimenti	Prezzo	Pz	Off. Pubbico	D.
FO410CR-001	Cromo	86,79 €	5	€ 75,94	22



## SERIE MAIA

Fonte Lavabo Alto 3/8 C/Scar Crmaia

Codice	Riferimenti	Prezzo	Pz	Off. Pubbico	D.
FO350CR-001	Cromo	140,36 €	5	€ 122,82	10



## SERIE MAIA

Fonte Lavabo 3/8 C/Scar Cr Maia

Codice	Riferimenti	Prezzo	Pz	Off. Pubbico	D.
FO310CR-001	Cromo	86,79 €	5	€ 75,94	42

## SERIE MAIA

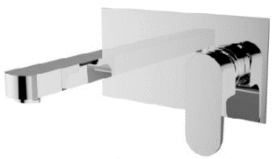
Fonte Lavabo Incasso C/Scar Cr

Codice	Riferimenti	Prezzo	Pz	Off. Pubbico	D.
FO301CR-001	Cromo	189,76 €	5	€ 166,04	5





## Mix Bidet Helios2 C/Scarico



Codice	Riferimenti	Prezzo	Pz	Off. Pubbico	D.
HN403CR11NZ	Cromo	47,09 €	5	€ 41,21	114
HN403CR11NZ					



## Mix Lavabo Helios2 C/Scarico

Codice	Riferimenti	Prezzo	Pz	Off. Pubbico	D.
HN303CR11NZ	Cromo	47,09 €	5	€ 41,21	136
HN303CR11NZ					



## Mix Doccia Incasso Helios 2



Codice	Riferimenti	Prezzo	Pz	Off. Pubbico	D.
HN001CR00NZ	Cromo	37,18 €	5	€ 32,53	158
HN001CR00NZ					



## Mix Doccia Incasso Cromo Profilo



Codice	Riferimenti	Prezzo	Pz	Off. Pubbico	D.
PR009CR00QZ	Cromo	38,12 €	5	€ 33,35	71
PR009CR00QZ					



Monocomando  
Lavabo Con Scarico  
Automatico Mix 18  
Ascot

**ASCOT**

Codice	Cod. Off.	Pz	Prezzo	Costo tot.	D.
MIX018/A	MIX018/A	1	43,38 €	€ 43,38	1
<b>Listino</b>	MIX018/AX5	5	40,48 €	€ 202,42	
48,20 €	MIX018/AX10	10	38,56 €	€ 385,56	
	MIX018/AX15	15	35,66 €	€ 534,96	



Monocomando Bidet  
Con Scarico  
Automatico Mix 16  
Ascot

**ASCOT**

Codice	Cod. Off.	Pz	Prezzo	Costo tot.	D.
MIX016/A	MIX016/A	1	43,38 €	€ 43,38	9
<b>Listino</b>	MIX016/AX5	5	40,48 €	€ 202,42	
48,20 €	MIX016/AX10	10	38,56 €	€ 385,56	
	MIX016/AX15	15	35,66 €	€ 534,96	



Gruppo Vasca  
Esterno Con  
Flessibile E Doccetta  
Mix 10 Bob

**ASCOT**

Codice	Cod. Off.	Pz	Prezzo	Costo tot.	D.
MIX010/B	MIX010/B	1	98,23 €	€ 98,23	15
<b>Listino</b>	MIX010/BX5	5	91,68 €	€ 458,42	
109,15 €	MIX010/BX10	10	87,32 €	€ 873,18	
	MIX010/BX15	15	80,77 €	€1.211,54	



Miscelatore Doccia  
Incasso Mix 14  
Ascot

**ASCOT**

Codice	Cod. Off.	Pz	Prezzo	Costo tot.	D.
MIX014/A	MIX014/A	1	35,72 €	€ 35,72	0
<b>Listino</b>	MIX014/AX5	5	33,34 €	€ 166,70	
39,69 €	MIX014/AX10	10	31,75 €	€ 317,52	
	MIX014/AX15	15	29,37 €	€ 440,56	



Miscelatore Doccia  
1/2" Pollice Mix 23  
Ascot

**ASCOT**

Codice	Cod. Off.	Pz	Prezzo	Costo tot.	D.
MIX023/A	MIX023/A	1	38,27 €	€ 38,27	9
<b>Listino</b>	MIX023/AX5	5	35,72 €	€ 178,61	
42,53 €	MIX023/AX10	10	34,02 €	€ 340,20	
	MIX023/AX15	15	31,47 €	€ 472,03	



Monocomando  
Lavabo Con Canna  
Fusa Mix 21 Ascot

**ASCOT**

Codice	Cod. Off.	Pz	Prezzo	Costo tot.	D.
MIX021/A	MIX021/A	1	43,38 €	€ 43,38	2
<b>Listino</b>	MIX021/AX5	5	40,48 €	€ 202,42	
48,20 €	MIX021/AX10	10	38,56 €	€ 385,56	
	MIX021/AX15	15	35,66 €	€ 534,96	



Gruppo Lavello  
Parete Con Canna  
Girevole Mix 22  
Ascot

**ASCOT**

Codice	Cod. Off.	Pz	Prezzo	Costo tot.	D.
MIX022/A	MIX022/A	1	48,48 €	€ 48,48	6
<b>Listino</b>	MIX022/AX5	5	45,25 €	€ 226,23	
53,87 €	MIX022/AX10	10	43,09 €	€ 430,92	
	MIX022/AX15	15	39,86 €	€ 597,90	



Miscelatore Lavello  
Professionale Chef  
Mixer



**ARVEN**  
CHEF MIXER

Codice	Cod. Off.	Pz	Prezzo	Costo tot.	D.
MIXCHEF	MIXCHEF	1	196,47 €	€ 196,47	16
<b>Listino</b>	MIXCHEFX5	5	183,37 €	€ 916,84	
218,30 €	MIXCHEFX10	10	174,64 €	€1.746,36	
	MIXCHEFX15	15	161,54 €	€2.423,07	



Gruppo Lavello  
Parete Con Canna  
Girevole Mix 22  
Maxima

**ASCOT**

Codice	Cod. Off.	Pz	Prezzo	Costo tot.	D.
MIX022/M	MIX022/M	1	56,13 €	€ 56,13	1
<b>Listino</b>	MIX022/MX5	5	52,39 €	€ 261,95	
62,37 €	MIX022/MX10	10	49,90 €	€ 498,96	
	MIX022/MX15	15	46,15 €	€ 692,31	



Gruppo Lavello  
Parete Con Canna  
Girevolea Mix 22  
Bob

Codice	Cod. Off.	Pz	Prezzo	Costo tot.	D.
MIX022/B	MIX022/B	1	63,79 €	€ 63,79	14
<b>Listino</b>	MIX022/BX5	5	59,54 €	€ 297,68	
70,88 €	MIX022/BX10	10	56,70 €	€ 567,00	
	MIX022/BX15	15	52,45 €	€ 786,71	



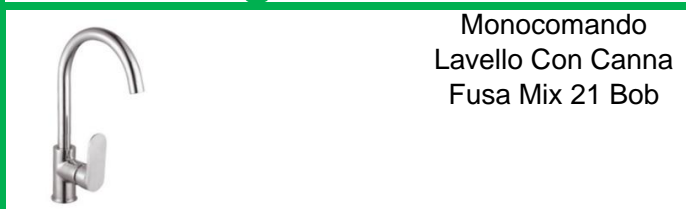

Monocomando  
Lavello Con Canna  
Fusa Mix 21 Bob

Codice	Cod. Off.	Pz	Prezzo	Costo tot.	D.
MIX021/B	MIX021/B	1	66,34 €	€ 66,34	1
Listino	MIX021/BX5	5	61,92 €	€ 309,58	
73,71 €	MIX021/BX10	10	58,97 €	€ 589,68	
	MIX021/BX15	15	54,55 €	€ 818,18	

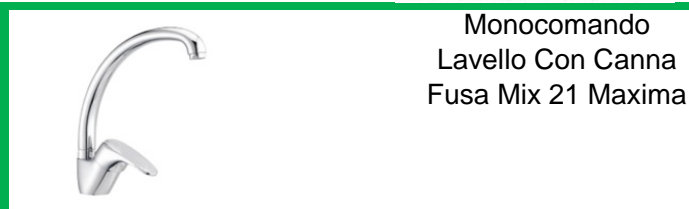

Monocomando  
Lavello Con Canna  
Fusa Mix 21 Maxima

Codice	Cod. Off.	Pz	Prezzo	Costo tot.	D.
MIX021/M	MIX021/M	1	47,20 €	€ 47,20	4
Listino	MIX021/MX5	5	44,06 €	€ 220,28	
52,45 €	MIX021/MX10	10	41,96 €	€ 419,58	
	MIX021/MX15	15	38,81 €	€ 582,17	



Monocomando Bidet  
Con Scarico  
Automatico Mix 16  
Maxima



ARVEN  
MAXIMA-B

Codice	Cod. Off.	Pz	Prezzo	Costo tot.	D.
MIX016/M	MIX016/M	1	57,41 €	€ 57,41	65
Listino	MIX016/MX5	5	53,58 €	€ 267,91	
63,79 €	MIX016/MX10	10	51,03 €	€ 510,30	
	MIX016/MX15	15	47,20 €	€ 708,04	



Monocomando Bidet  
Con Scarico  
Automatico Mix 16  
Bob

Codice	Cod. Off.	Pz	Prezzo	Costo tot.	D.
MIX016/B	MIX016/B	1	58,68 €	€ 58,68	17
Listino	MIX016/BX5	5	54,77 €	€ 273,86	
65,21 €	MIX016/BX10	10	52,16 €	€ 521,64	
	MIX016/BX15	15	48,25 €	€ 723,78	

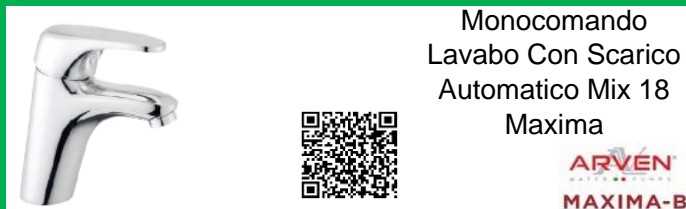

Monocomando  
Lavabo Con Scarico  
Automatico Mix 18  
Maxima



ARVEN  
MAXIMA-B

Codice	Cod. Off.	Pz	Prezzo	Costo tot.	D.
MIX018/M	MIX018/M	1	57,41 €	€ 57,41	52
Listino	MIX018/MX5	5	53,58 €	€ 267,91	
63,79 €	MIX018/MX10	10	51,03 €	€ 510,30	
	MIX018/MX15	15	47,20 €	€ 708,04	

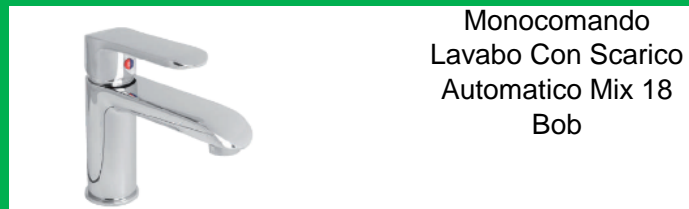

Monocomando  
Lavabo Con Scarico  
Automatico Mix 18  
Bob

Codice	Cod. Off.	Pz	Prezzo	Costo tot.	D.
MIX018/B	MIX018/B	1	63,79 €	€ 63,79	5
Listino	MIX018/BX5	5	59,54 €	€ 297,68	
70,88 €	MIX018/BX10	10	56,70 €	€ 567,00	
	MIX018/BX15	15	52,45 €	€ 786,71	



Gruppo Vasca  
Esterno Con  
Flessibile E Doccetta  
Mix 10 Bob

Codice	Cod. Off.	Pz	Prezzo	Costo tot.	D.
MIX010/B	MIX010/B	1	98,23 €	€ 98,23	15
Listino	MIX010/BX5	5	91,68 €	€ 458,42	
109,15 €	MIX010/BX10	10	87,32 €	€ 873,18	
	MIX010/BX15	15	80,77 €	€ 1.211,54	



Gruppo Vasca  
Esterno Con  
Flessibile E Doccetta  
Mix 10 Maxima



ARVEN  
MAXIMA-B

Codice	Cod. Off.	Pz	Prezzo	Costo tot.	D.
MIX010/M	MIX010/M	1	71,44 €	€ 71,44	17
Listino	MIX010/MX5	5	66,68 €	€ 333,40	
79,38 €	MIX010/MX10	10	63,50 €	€ 635,04	
	MIX010/MX15	15	58,74 €	€ 881,12	

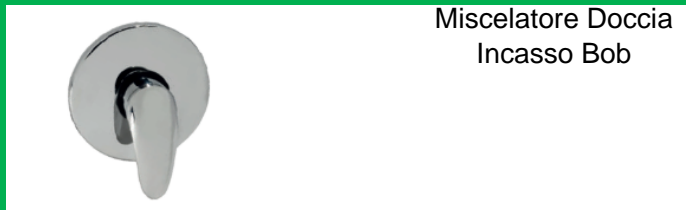

Miscelatore Doccia  
Incasso Bob

Codice	Cod. Off.	Pz	Prezzo	Costo tot.	D.
MIX014/B	MIX014/B	1	49,75 €	€ 49,75	5
Listino	MIX014/BX5	5	46,44 €	€ 232,19	
55,28 €	MIX014/BX10	10	44,23 €	€ 442,26	
	MIX014/BX15	15	40,91 €	€ 613,64	

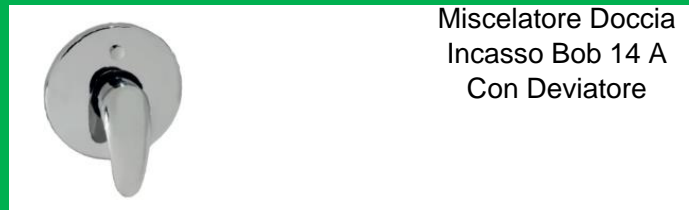

Miscelatore Doccia  
Incasso Bob 14 A  
Con Deviatore

Codice	Cod. Off.	Pz	Prezzo	Costo tot.	D.
MIX014A/B	MIX014A/B	1	88,03 €	€ 88,03	1
Listino	MIX014A/BX5	5	82,16 €	€ 410,79	
97,81 €	MIX014A/BX10	10	78,25 €	€ 782,46	
	MIX014A/BX15	15	72,38 €	€ 1.085,66	



**GROHE**

Bauedge Set Misce.  
Monocomando  
Vasca Inc. Doccia  
Grohe



Codice	Riferimenti	Prezzo	Pz	Off. Pubbico	D.
29079000		131,43 €	10	€ 115,00	6



**GROHE**

Bauedge  
Miscelatore  
Monocomando Bidet  
Grohe



Codice	Riferimenti	Prezzo	Pz	Off. Pubbico	D.
23331000		68,06 €	10	€ 59,55	11



Lavello Cucina Bg  
De 2F Hide Cromo



Codice	Cod. Off.	Pz	Off. Pubbico	Costo tot.	D.
KI510CR00KZ	KI510CR00KZ	1	255,43 €	€ 255,43	9
<b>Listino</b>	KI510CR00KZX5	5	238,40 €	€1.192,02	
283,82 €	KI510CR00KZX10	10	227,05 €	€2.270,52	
	KI510CR00KZX15	15	210,02 €	€3.150,35	

FINITURA DISPONIBILE:  
TERRA DI FRANCIA



TerraFrancia

Mix Lavello Parete  
Debora Terra Di  
Francia

**ARMANDO VICARIO**



Codice	Cod. Off.	Pz	Off. Pubbico	Costo tot.	D.
MLPDE100	MLPDE100	1	125,57 €	€ 125,57	82
<b>Listino</b>	MLPDE100X5	5	117,20 €	€ 586,01	
139,53 €	MLPDE100X10	10	111,62 €	€1.116,22	
	MLPDE10015	15	103,25 €	€1.548,75	



**ZIPPONI**  
LACQUALITÀ È LO STILE

Mix Lavello Botticella  
Cocca Conica  
Standard

Codice	Cod. Off.	Pz	Off. Pubbico	Costo tot.	D.
AA630CR10LZ	AA630CR10LZ	1	91,00 €	€ 91,00	80
<b>Listino</b>	AA630CR10LZX5	5	84,94 €	€ 424,68	
101,12 €	AA630CR10LZX10	10	80,89 €	€ 808,92	
	AA630CR10LZX15	15	74,83 €	€1.122,38	



**GROHE**

Bauedge  
Miscelatore  
Monocomando  
Lavabo Taglia M  
Grohe



Codice	Riferimenti	Prezzo	Pz	Off. Pubbico	D.
23758000		82,14 €	10	€ 71,87	10



**GROHE**

Bauedge  
Miscelatore  
Monocomando Bidet  
Grohe



Codice	Riferimenti	Prezzo	Pz	Off. Pubbico	D.
23331000		68,06 €	10	€ 59,55	11



Mix Bidet Alessia  
Cart. Da 35



Codice	Cod. Off.	Pz	Off. Pubbico	Costo tot.	D.
MBA00	MBA00	1	17,51 €	€ 17,51	218
<b>Listino</b>	MBA00X5	5	16,58 €	€ 82,92	
18,43 €	MBA00X10	10	15,76 €	€ 157,56	
	MBA00X15	15	14,93 €	€ 223,89	



Miscelatore  
Monocomando Per  
Lavello Cucina Con  
Canna Ponte. Mix/62

**ARMANDO VICARIO**

Codice	Cod. Off.	Pz	Off. Pubbico	Costo tot.	D.
MIX6200	MIX6200	1	107,16 €	€ 107,16	73
<b>Listino</b>	MIX6200X5	5	100,02 €	€ 500,09	
119,07 €	MIX6200X10	10	95,26 €	€ 952,56	
	MIX6200X15	15	88,11 €	€1.321,68	



**ZIPPONI**  
LACQUALITÀ È LO STILE

Mix Cucina Leva  
Laterale Can. L  
F.3/8

Codice	Cod. Off.	Pz	Off. Pubbico	Costo tot.	D.
CU643CR10LZ	CU643CR10LZ	1	90,72 €	€ 90,72	23
<b>Listino</b>	CU643CR10LZX5	5	84,67 €	€ 423,36	
100,80 €	CU643CR10LZX10	10	80,64 €	€ 806,40	
	CU643CR10LZX15	15	74,59 €	€1.118,88	

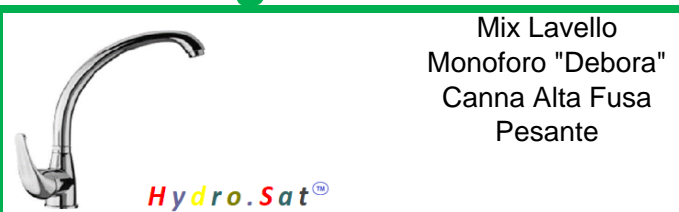

Mix Lavello  
Monoforo "Debora"  
Canna Alta Fusa  
Pesante

Hydro.Sat<sup>®</sup>

Codice	Cod. Off.	Pz	Off. Pubbico	Costo tot.	D.
MLMLLDE00	MLMLLDE00	1	110,22 €	€ 110,22	137
<b>Listino</b>	MLMLLDE00X5	5	102,88 €	€ 514,38	
122,47 €	MLMLLDE00X10	10	97,98 €	€ 979,78	
	MLMLLDE00X15	15	90,63 €	€ 1.359,44	

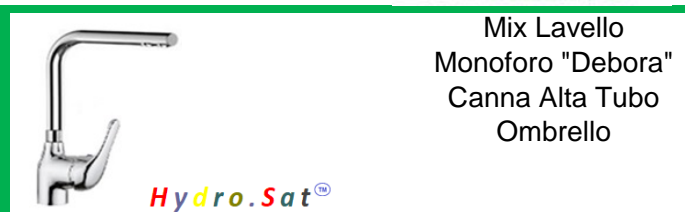

Mix Lavello  
Monoforo "Debora"  
Canna Alta Tubo  
Ombrello

Hydro.Sat<sup>®</sup>

Codice	Cod. Off.	Pz	Off. Pubbico	Costo tot.	D.
MLMLPDE00	MLMLPDE00	1	73,48 €	€ 73,48	48
<b>Listino</b>	MLMLPDE00X5	5	68,58 €	€ 342,92	
81,65 €	MLMLPDE00X10	10	65,32 €	€ 653,18	
	MLMLPDE00X15	15	60,42 €	€ 906,29	



Miscelatore Lavello  
Monoforo canna alta  
Mod. Jolla Mix/30  
Onda Cromato

ARMANDO  
VICARIO

Codice	Cod. Off.	Pz	Off. Pubbico	Costo tot.	D.
JOLLA00	JOLLA00	1	79,73 €	€ 79,73	51
<b>Listino</b>	JOLLA00X5	5	74,41 €	€ 372,07	
88,59 €	JOLLA00X10	10	70,87 €	€ 708,70	
	JOLLA00X15	15	65,56 €	€ 983,33	



Mix Lav. Mon.Rodeo  
Mix/3 Cromo

ARMANDO  
VICARIO

Codice	Cod. Off.	Pz	Off. Pubbico	Costo tot.	D.
RODEO00	RODEO00	1	107,16 €	€ 107,16	199
<b>Listino</b>	RODEO00x5	5	100,02 €	€ 500,09	
119,07 €	RODEO00x10	10	95,26 €	€ 952,56	
	RODEO00x15	15	88,11 €	€ 1.321,68	

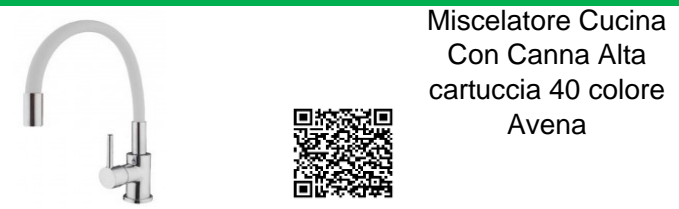

Miscelatore Cucina  
Con Canna Alta  
cartuccia 40 colore  
Avena

Codice	Riferimenti	Prezzo	Pz	Off. Pubbico	D.
52943		41,62 €	10	€ 36,42	1



Miscelatore lavello  
Monoforo Canna  
Alta Avena

Codice	Riferimenti	Prezzo	Pz	Off. Pubbico	D.
69146		48,33 €	10	€ 42,29	6

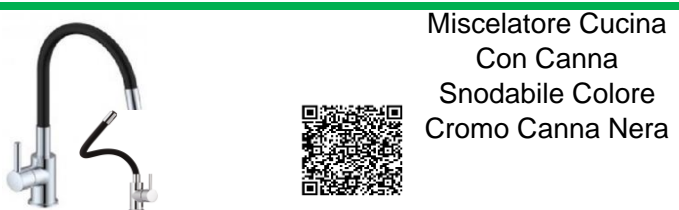

Miscelatore Cucina  
Con Canna  
Snodabile Colore  
Cromo Canna Nera

Codice	Riferimenti	Prezzo	Pz	Off. Pubbico	D.
69410		44,30 €	10	€ 38,77	1



Miscelatore lavello  
Monoforo Canna  
Alta Cromo

Codice	Riferimenti	Prezzo	Pz	Off. Pubbico	D.
69145		49,67 €	10	€ 43,47	6



Miscelatore Cucina  
Con Doccetta  
Estraibile Cromato

Codice	Riferimenti	Prezzo	Pz	Off. Pubbico	D.
79569		75,18 €	10	€ 65,78	25



Miscelatore lavello  
Monoforo Canna  
Alta Bianco

Codice	Riferimenti	Prezzo	Pz	Off. Pubbico	D.
79830		51,02 €	10	€ 44,64	7

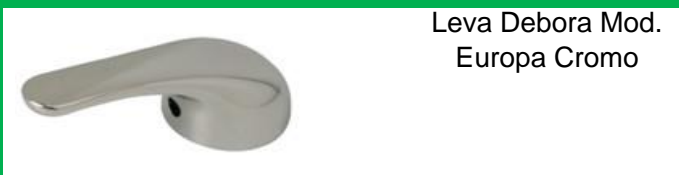

Leva Debora Mod.  
Europa Cromo

Codice	Cod. Off.	Pz	Off. Pubbico	Costo tot.	D.
LDE00	LDE00	1	9,53 €	€ 9,53	3
<b>Listino</b>	LDE00X5	5	9,07 €	€ 45,36	
11,34 €	LDE00X10	10	8,62 €	€ 86,18	



Leva Clinica Debora  
Cromo

Codice	Cod. Off.	Pz	Off. Pubbico	Costo tot.	D.
LCD00	LCD00	1	15,53 €	€ 15,53	157
<b>Listino</b>	LCD00X5	5	14,50 €	€ 72,49	
17,26 €	LCD00X10	10	13,81 €	€ 138,08	





Mix Lavello Monof.  
Alessia

Codice	Cod. Off.	Pz	Off. Pubbico	Costo tot.	D.
MLMAE00	MLMAE00	1	22,57 €	€ 22,57	870
<b>Listino</b>	MLMAE00X5	5	21,38 €	€ 106,91	
23,76 €	MLMAE00X10	10	20,31 €	€ 203,12	
	MLMAE00X15	15	19,24 €	€ 288,65	



Mix Lavello Mon.  
Later. Debora Canna  
Alta Pesante Cromo



Codice	Cod. Off.	Pz	Off. Pubbico	Costo tot.	D.
MLMLDE00	MLMLDE00	1	45,36 €	€ 45,36	471
<b>Listino</b>	MLMLDE00X5	5	42,34 €	€ 211,68	
50,40 €	MLMLDE00X10	10	40,32 €	€ 403,20	
	MLMLDE00X15	15	37,30 €	€ 559,44	



Mix Lav. Mon.  
Malibu' Q Cr



Codice	Cod. Off.	Pz	Off. Pubbico	Costo tot.	D.
MALIBUQ00	MALIBUQ00	1	39,69 €	€ 39,69	185
<b>Listino</b>	MALIBUQ00X5	5	37,04 €	€ 185,22	
44,10 €	MALIBUQ00X10	10	35,28 €	€ 352,80	
	MALIBUQ00X15	15	32,63 €	€ 489,51	

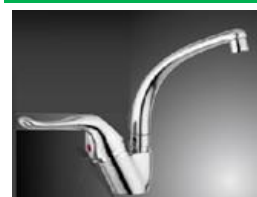

Mix Lav. Fo-20-Re  
Cromo Leva Chiusa



Codice	Cod. Off.	Pz	Off. Pubbico	Costo tot.	D.
FO20RE	FO20RE	1	48,20 €	€ 48,20	93
<b>Listino</b>	FO20REX5	5	44,98 €	€ 224,91	
53,55 €	FO20REX10	10	42,84 €	€ 428,40	
	FO20REX15	15	39,63 €	€ 594,41	



Mix Lavello Mon.  
Canna Alta Pesante  
Cromo

Codice	Cod. Off.	Pz	Off. Pubbico	Costo tot.	D.
MLMLANR00	MLMLANR00	1	93,56 €	€ 93,56	25
<b>Listino</b>	MLMLANR00X5	5	87,32 €	€ 436,59	
103,95 €	MLMLANR00X10	10	83,16 €	€ 831,60	
	MLMLANR00X15	15	76,92 €	€1.153,85	



Mix Cucina Leva  
Laterale Canna  
Conica Cm. 28  
Granito - Avena



Codice	Cod. Off.	Pz	Off. Pubbico	Costo tot.	D.
AA620GA10LZ	AA620GA10LZ	1	86,47 €	€ 86,47	112
<b>Listino</b>	AA620GA10LZX5	5	80,70 €	€ 403,52	
96,08 €	AA620GA10LZX10	10	76,86 €	€ 768,60	
	AA620GA10LZX15	15	71,10 €	€1.066,43	



Mix Lavello Mon.  
Debora Granito  
Rosa



Codice	Cod. Off.	Pz	Off. Pubbico	Costo tot.	D.
MLMLDE82	MLMLDE82	1	79,76 €	€ 79,76	82
<b>Listino</b>	MLMLDE82X5	5	74,44 €	€ 372,21	
88,62 €	MLMLDE82X10	10	70,90 €	€ 708,98	
	MLMLDE82X15	15	65,58 €	€ 983,71	



Mix Lav. Mon. Malibu'  
Due P Cr



Codice	Cod. Off.	Pz	Off. Pubbico	Costo tot.	D.
MALIBU2P00	MALIBU2P00	1	39,69 €	€ 39,69	145
<b>Listino</b>	MALIBU2P00X5	5	37,04 €	€ 185,22	
44,10 €	MALIBU2P00X10	10	35,28 €	€ 352,80	
	MALIBU2P00X15	15	32,63 €	€ 489,51	



Mix Lav. 110 Cromo  
Leva Aperta



Codice	Cod. Off.	Pz	Off. Pubbico	Costo tot.	D.
110FMIX	110FMIX	1	48,20 €	€ 48,20	143
<b>Listino</b>	110FMIX5	5	44,98 €	€ 224,91	
#N/D	110FMIXX10	10	42,84 €	€ 428,40	
	110FMIXX15	15	39,63 €	€ 594,41	



Mix Cucina Leva  
Laterale P



Codice	Cod. Off.	Pz	Off. Pubbico	Costo tot.	D.
AA622CR10LZ	AA622CR10LZ	1	68,04 €	€ 68,04	88
<b>Listino</b>	AA622CR10LZX5	5	63,50 €	€ 317,52	
75,60 €	AA622CR10LZX10	10	60,48 €	€ 604,80	
	AA622CR10LZX15	15	55,94 €	€ 839,16	

**SERIE LIBERTY**





Mix Lav. Mon.  
Liberty Cromo Con  
Bocca Girevole Mm.  
260



Cromato

Codice	Cod. Off.	Pz	Off. Pubbico	Costo tot.	D.
7695CR	7695CR	1	100,44 €	€ 100,44	76
<b>Listino</b>	7695CRX5	5	93,75 €	€ 468,74	
111,60 €	7695CRX10	10	89,28 €	€ 892,84	
	7695CRX15	15	82,59 €	€1.238,81	

**SERIE LIBERTY**

Mix Lav.Mon.Liberty  
Bronzo Con Bocca  
Girevole Mm. 260



Bronzato

Codice	Cod. Off.	Pz	Off. Pubbico	Costo tot.	D.
7695VO	7695VO	1	155,78 €	€ 155,78	10
<b>Listino</b>	7695VOX5	5	145,40 €	€ 726,99	
173,09 €	7695VOX0	10	138,47 €	€1.384,74	
	7695VOX15	15	128,09 €	€1.921,33	

**SERIE LUXOR**



Mix Lav. Mon. Luxor  
Cromo Con Bocca  
Girevole Mm. 302

Codice	Cod. Off.	Pz	Off. Pubbico	Costo tot.	D.
0170CR	0170CR	1	297,28 €	€ 297,28	5
<b>Listino</b>	0170CRX5	5	277,46 €	€1.387,31	
330,31 €	0170CRX10	10	264,25 €	€2.642,49	
	0170CRX15	15	244,43 €	€3.666,46	

**FARIS**



Mix Lav. Mon.  
Quadric Cromo Con  
Bocca Girevole Mm.  
320

Codice	Cod. Off.	Pz	Off. Pubbico	Costo tot.	D.
16720CR	16720CR	1	199,90 €	€ 199,90	66
<b>Listino</b>	16720CRX5	5	186,57 €	€ 932,85	
222,11 €	16720CRX10	10	177,69 €	€1.776,85	
	16720CRX15	15	164,36 €	€2.465,38	

Mix Lav. Mon.  
Mix/54 Cromo  
Canna A Ponte



CROMATO  
BRONZE BR  
RAME RM  
Terra Francia

Codice	Cod. Off.	Pz	Off. Pubbico	Costo tot.	D.
MIX5400	MIX5400	1	96,39 €	€ 96,39	9
<b>Listino</b>	MIX5400X5	5	89,96 €	€ 449,82	
107,10 €	MIX5400X10	10	85,68 €	€ 856,80	
	MIX5400X15	15	79,25 €	€1.188,81	

**SERIE LAKE**



Mix Lavello Mon.  
Lake Cromo Con  
Bocca Girevole Fusa  
Mm.318

Codice	Cod. Off.	Pz	Off. Pubbico	Costo tot.	D.
0175CR	0175CR	1	189,64 €	€ 189,64	3
<b>Listino</b>	0175CRX5	5	177,00 €	€ 884,98	
210,71 €	0175CRX10	10	168,57 €	€1.685,67	
	0175CRX15	15	155,92 €	€2.338,86	

**ARMANDO VICARIO**



Mix Lav. Mon.  
Mix/62 Sf Cr  
C/Canna Reclinabile  
Sottofin.



Codice	Cod. Off.	Pz	Off. Pubbico	Costo tot.	D.
MIX62SF00	MIX62SF00	1	153,77 €	€ 153,77	65
<b>Listino</b>	MIX62SF00X5	5	143,52 €	€ 717,60	
170,86 €	MIX62SF00X10	10	136,68 €	€1.366,85	
	MIX62SF00X15	15	126,43 €	€1.896,50	

Mix Lav.Mon.Mix/20  
Sf Bronzo Dis.In  
Cer.Can.Ponte  
Sottofin.



CROMATO  
BRONZE BR  
RAME RM  
Terra Francia

Codice	Cod. Off.	Pz	Off. Pubbico	Costo tot.	D.
MIX20SF47	MIX20SF47	1	213,56 €	€ 213,56	32
<b>Listino</b>	MIX20SF47X5	5	199,32 €	€ 996,62	
237,29 €	MIX20SF47X10	10	189,83 €	€1.898,32	
	MIX20SF47X15	15	175,59 €	€2.633,91	

**SPHERA**  
DOCCE & ACCESSORI



Setcucina  
C/Molla,Sof.Sd4011



Codice	Cod. Off.	Pz	Off. Pubbico	Costo tot.	D.
RU0011003CR	RU0011003CR	1	214,33 €	€ 214,33	62
<b>Listino</b>	RU0011003CRX5	5	200,04 €	€1.000,19	
238,14 €	RU0011003CRX10	10	190,51 €	€1.905,12	
	RU0011003CRX15	15	176,22 €	€2.643,35	

Mix Lavello Mon.  
Mix/56 Cr Con  
Canna Old Fashion



CROMATO  
BRONZE BR  
RAME RM  
Terra Francia

Codice	Cod. Off.	Pz	Off. Pubbico	Costo tot.	D.
MIX5600	MIX5600	1	107,73 €	€ 107,73	14
<b>Listino</b>	MIX5600X5	5	100,55 €	€ 502,74	
119,70 €	MIX5600X10	10	95,76 €	€ 957,60	
	MIX5600X15	15	88,58 €	€1.328,67	



Mix Lavello Mon.  
Lat. Debora Bianco



Codice	Riferimenti	Prezzo	Pz	Off. Pubbico	D.
MLMLDE04		41,89 €	10	€ 36,65	28



Mix Lavello Monof.  
Alessia

Codice	Riferimenti	Prezzo	Pz	Off. Pubbico	D.
MLMAE00		22,57 €	10	€ 19,75	870



Mix Lavello Mon.  
Debora Canna  
Bassa Attacco  
Lavatrice

**ZIPPONI**  
LA QUALITÀ È LO STILE

Codice	Riferimenti	Prezzo	Pz	Off. Pubbico	D.
AA609CR10LZ		72,92 €	10	€ 63,81	24



**early**  
OSMOSI

Miscelatore cucina per filtro  
d'acqua potabile acciaio inox  
linea osmosi o acqua diretta



Codice	Cod. Off.	Prezzo	Pz	Off. Pubbico	D.
52691		94,19 €	10	€ 82,41	21



Mix Lavello Parete  
Debora Cr.

**SPHERA**  
TRACCE & APPASSIONI

Codice	Riferimenti	Prezzo	Pz	Off. Pubbico	D.
MLPDE00		42,51 €	10	€ 37,19	285



Mix Lav. Mon. Doc  
/Estr. Debora  
Cartuccia 40

**ARMANDO  
VICARIO**

Codice	Riferimenti	Prezzo	Pz	Off. Pubbico	D.
MLMEDE00		97,59 €	10	€ 85,39	104



Mix Lavello  
Monoforo "Debora"  
Canna Alta Tubo  
Squadra Terra Di  
Francia Cod. Interno  
400217Vic00Td

TerraFrancia

Codice	Riferimenti	Prezzo	Pz	Off. Pubbico	D.
MLMLDE100		71,82 €	10	€ 62,84	22



Mix Debora Lav.  
Mon. C /Bassa

Codice	Riferimenti	Prezzo	Pz	Off. Pubbico	D.
MLMDE00		29,74 €	10	€ 26,02	174



Mix Lavello Mon.  
Diretta Debora  
Canna Bassa

**ARMANDO  
VICARIO**



Codice	Riferimenti	Prezzo	Pz	Off. Pubbico	D.
MLMDDE00		83,13 €	10	€ 72,74	86



Mix Lavello Monoforo  
"Debora" Canna Alta Tubo  
Pesante

**Hydro.Sat**™



Codice	Riferimenti	Prezzo	Pz	Off. Pubbico	D.
MLMLLPDE00		100,71 €	10	€ 88,12	67



Mix Debora Lavello  
Monof. Canna Alta  
Pes. Gran. Beige

**SPHERA**  
TRACCE & APPASSIONI

Codice	Riferimenti	Prezzo	Pz	Off. Pubbico	D.
MLMLDE85	Avena	44,61 €	10	€ 39,04	107



Mix Lavello Mon.  
Debora Lux Canna  
Old Fashion

**Hydro.Sat**™

Codice	Riferimenti	Prezzo	Pz	Off. Pubbico	D.
MLMLOF00		116,18 €	10	€ 101,66	95





Mix Lavabo Drewi  
Cartuccia 40  
Completo Import

Codice	Riferimenti	Prezzo	Pz	Off. Pubbico	D.
JH-8091	Cromo	38,34 €	10	€ 33,55	110



Mix Vasca Drewi  
Cartuccia 40  
Completo Import



Codice	Riferimenti	Prezzo	Pz	Off. Pubbico	D.
JH-8092	Cromo	35,50 €	10	€ 31,06	18



Miscelatore Lavello  
Canna Alta

Codice	Riferimenti	Prezzo	Pz	Off. Pubbico	D.
JH-8065	Cromo	24,14 €	10	€ 21,12	119



Mix Lavello Cucina  
Drewi Cartuccia 40  
Import Zx



Codice	Riferimenti	Prezzo	Pz	Off. Pubbico	D.
JH-8095W	Cromo	34,08 €	10	€ 29,82	57



Mix Lavello Cucina  
Canna Alta Drewi  
Cartuccia 40 Avena  
Import

Codice	Riferimenti	Prezzo	Pz	Off. Pubbico	D.
JH-8195D	Avena	36,92 €	10	€ 32,31	9



Mix Lavello Cucina  
Drewi Cartuccia 40  
Import Zx

Codice	Riferimenti	Prezzo	Pz	Off. Pubbico	D.
JH-1586	Cromo	26,98 €	10	€ 23,61	42



Mix Bidet Drewi  
Cartuccia 40  
Completo Import



Codice	Riferimenti	Prezzo	Pz	Off. Pubbico	D.
JH-8099	Cromo	39,76 €	10	€ 34,79	53



Mix Lavello Cucina  
Drewi Cartuccia 40  
Import



Codice	Riferimenti	Prezzo	Pz	Off. Pubbico	D.
JH-8095D	Cromo	36,92 €	10	€ 32,31	138



Mix Lavello Cucina  
Driwei Cartuccia 40  
Import Zx



Codice	Riferimenti	Prezzo	Pz	Off. Pubbico	D.
JH-8063	Cromo	34,08 €	10	€ 29,82	21



Mix Lavello Cucina  
Inox Drewi Cartuccia  
40 Import Zx



Codice	Riferimenti	Prezzo	Pz	Off. Pubbico	D.
S9008	Cromo	42,60 €	10	€ 37,28	20



Mix Lavello Cucina  
Driwei Cartuccia 40  
Doccetta Estraibile  
Avena Import Zx

Codice	Riferimenti	Prezzo	Pz	Off. Pubbico	D.
JH-8816	Avena	42,60 €	10	€ 37,28	0



Miscelatore Lavello  
Pietra Sabbia  
Lavandino Lavello  
Cucina Monocomando  
Jh1585

Codice	Riferimenti	Prezzo	Pz	Off. Pubbico	D.
JH-1585	Avena	42,60 €	10	€ 37,28	3



Codice	Riferimenti	Prezzo	Pz	Off. Pubbico	D.
814-1	NERO	38,34 €	5	€ 33,55	17
814-2	BLUE	38,34 €	5	€ 33,55	1
814-3	VERDE	38,34 €	5	€ 33,55	3
814-4	ARANCIO	38,34 €	5	€ 33,55	0
814-5	BIANCO	38,34 €	5	€ 33,55	3
814-6	FUXIA	38,34 €	5	€ 33,55	0



Gruppo Lavello Parete  
Bronzo Francesca

Codice	Riferimenti	Prezzo	Pz	Off. Pubbico	D.
GLPF47	Bronzo	101,65 €	10	€ 88,95	2



Gruppo Lavello Parete  
Francesca

Codice	Riferimenti	Prezzo	Pz	Off. Pubbico	D.
GLPF100	T-Francia	95,19 €	10	€ 83,29	34



Gruppo Lavello Mon. D  
/Estr. 2 G. Bronzo  
Francesca

Codice	Riferimenti	Prezzo	Pz	Off. Pubbico	D.
GLMAEF47	Bronzo	206,25 €	10	€ 180,47	26

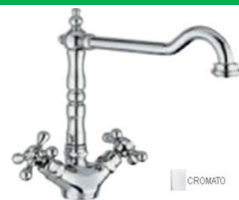

Gruppo Lavello  
Mono.B/Antica Francesca  
Cromo

Codice	Riferimenti	Prezzo	Pz	Off. Pubbico	D.
GLMAF00	Cromo	103,09 €	10	€ 90,21	108



Gruppo  
Lav.Mon.Francesca  
Acqua Diretta Bronzato  
Canna Ponte

Codice	Riferimenti	Prezzo	Pz	Off. Pubbico	D.
GLMDF47	Bronzo	107,09 €	10	€ 93,71	0



Gruppo Lavello Mon.  
C/Fusa Tiziana

Codice	Riferimenti	Prezzo	Pz	Off. Pubbico	D.
GLMFT	Cromo	46,46 €	10	€ 40,65	464

Rubinetti Colonna Bar  
Tiziana



Codice	Riferimenti	Prezzo	Pz	Off. Pubbico	D.
RCBT	Cromo	23,04 €	10	€ 20,16	100



Gruppo Lavello Parete  
Cromo Francesca

Codice	Riferimenti	Prezzo	Pz	Off. Pubbico	D.
GLPF00	Cromo	76,24 €	10	€ 66,71	4



Gruppo Lavello Parete  
Francesca Colore Bianco  
Cromo

Codice	Riferimenti	Prezzo	Pz	Off. Pubbico	D.
GLPF04	Bianco	95,19 €	10	€ 83,29	38



Gruppo Lavello Mon. D  
/Estr. 2 G. Cromo  
Francesca

Codice	Riferimenti	Prezzo	Pz	Off. Pubbico	D.
GLMAEF00	Cromo	157,07 €	10	€ 137,43	47



Gruppo Lavello Mon.  
B/Antica Francesca Rame

Codice	Riferimenti	Prezzo	Pz	Off. Pubbico	D.
GLMAF65	Rame	143,64 €	10	€ 125,69	6



Gruppo Lavello Mon.B  
/Antica Bronzo Acqua  
Diretta Francesca

Codice	Riferimenti	Prezzo	Pz	Off. Pubbico	D.
GLMADF47	Bronzo	166,58 €	10	€ 145,76	4



Gruppo Lavello Mon. C  
/Lusso Pesante Alta  
Tiziana

Codice	Riferimenti	Prezzo	Pz	Off. Pubbico	D.
GLMFAT	Cromo	39,14 €	10	€ 34,25	439

Rubinetti Snodo + Lav.  
Tiziana



Codice	Riferimenti	Prezzo	Pz	Off. Pubbico	D.
RRBTE	Cromo	24,77 €	10	€ 21,68	20



Gruppo Lavello  
Mon. Francesca Bz.  
Bronzo Canna Ponte

Codice	Riferimenti	Prezzo	Pz	Off. Pubbico	D.
GLMF47	Cromo	107,09 €	10	€ 93,71	38



Gruppo Lavello Parete  
Attacco Lavatrice Canna  
"U"

Codice	Riferimenti	Prezzo	Pz	Off. Pubbico	D.
GLPLUT	Cromo	63,25 €	10	€ 55,35	15



Rubinetto Rov. C /Snodo  
"U" Tiziana 1/2"



Codice	Riferimenti	Prezzo	Pz	Off. Pubbico	D.
RRUT	Cromo	24,04 €	10	€ 21,03	168



Gruppo Lavello Parete  
Tiziana

Codice	Riferimenti	Prezzo	Pz	Off. Pubbico	D.
GLPT	Cromo	40,48 €	10	€ 35,42	49



Gruppo Lavello  
Pareteattacco Lavatrice  
Canna "E"

Codice	Riferimenti	Prezzo	Pz	Off. Pubbico	D.
GLPLT	Cromo	63,25 €	10	€ 55,35	24



Rubinetto A Snodo  
Tiziana



Codice	Riferimenti	Prezzo	Pz	Off. Pubbico	D.
RRT	Cromo	24,04 €	10	€ 21,03	71



Gruppo Lavabo Tiziana  
Sc.1"

Codice	Riferimenti	Prezzo	Pz	Off. Pubbico	D.
GLT	Cromo	62,21 €	10	€ 54,44	138



Combin. Bidet Tiziana  
Sc.1"

Codice	Riferimenti	Prezzo	Pz	Off. Pubbico	D.
CBT	Cromo	37,95 €	10	€ 33,21	36



Gruppo Lavabo Mon.  
Tiziana

Codice	Cod. Off.	Pz	Prezzo	Costo tot.	D.
GLMT	GLMT	1	36,79 €	€ 36,79	95
<b>Listino</b>	GLMTX5	5	34,85 €	€ 174,27	
38,73 €	GLMTX10	10	33,11 €	€ 331,11	
	GLMTX15	15	31,37 €	€ 470,52	



Cartuccia Ricambio per  
miscelatori universali

Codice	Riferimenti	Prezzo	Pz	Off. Pubbico	D.
C35B	35 S-Distr.	3,39 €	10	€ 2,97	52
C40B	40 S-Distr.	3,39 €	10	€ 2,97	198
C35A	35 C-Distr.	3,39 €	10	€ 2,97	97
C40A	40 C-Distr.	3,39 €	10	€ 2,97	1346



Rubinetto Biuso Lav+Lav  
A Y

Codice	Cod. Off.	Pz	Prezzo	Costo tot.	D.
RBLYT	RBLYT	1	29,42 €	€ 29,42	30
<b>Listino</b>	RBLYTX5	5	27,87 €	€ 139,34	
30,96 €	RBLYTX10	10	26,47 €	€ 264,75	
	RBLYTX15	15	25,08 €	€ 376,22	



Cartuccia Nicolazzi

Codice	Cod. Off.	Pz	Prezzo	Costo tot.	D.
C3009	C3009	1	70,88 €	€ 70,88	27
<b>Listino</b>	C3009X5	5	66,15 €	€ 330,75	
78,75 €	C3009X10	10	63,00 €	€ 630,00	
	C3009X15	15	58,28 €	€ 874,13	





Rubinetto Biuso 1/2"  
Tiziana Ec Rbe00

Codice	Cod. Off.	Pz	Prezzo	Costo tot.	D.
RBTE	RBTE	1	13,71 €	€ 13,71	1368
<b>Listino</b>	RBTEx10	10	12,99 €	€ 129,90	
14,43 €	RBTEx20	20	12,34 €	€ 246,81	
	RBTEx50	50	11,69 €	€ 584,55	



Rubinetto Full 1/2"  
Marziano

Codice	Cod. Off.	Pz	Prezzo	Costo tot.	D.
RF1/2	RF1/2	1	11,07 €	€ 11,07	154
<b>Listino</b>	RF1/2x6	10	10,46 €	€ 104,58	
12,30 €	RF1/2x12	20	9,84 €	€ 196,86	
	RF1/2x24	50	9,10 €	€ 455,24	



Rubinetto Ful 1/2" Port.  
Marz.

Codice	Cod. Off.	Pz	Prezzo	Costo tot.	D.
RF1/2P	RF1/2P	1	13,81 €	€ 13,81	185
<b>Listino</b>	RF1/2Px6	10	13,04 €	€ 130,45	
15,35 €	RF1/2Px12	20	12,28 €	€ 245,55	
	RF1/2Px24	50	11,36 €	€ 567,83	



Rubinetto 1/2 C/Vitone Rapido 1/4 Di Giro Leva

Codice	Cod. Off.	Pz	Prezzo	Costo tot.	D.
669	669	1	12,87 €	€ 12,87	27
<b>Listino</b>	669X5	5	12,19 €	€ 60,95	
13,55 €	669X10	10	11,58 €	€ 115,81	
	669X20	20	10,97 €	€ 219,43	



Rubinetto Artistico 1/2"  
Vitone

Codice	Cod. Off.	Pz	Prezzo	Costo tot.	D.
RA1/2V	RA1/2V	1	27,65 €	€ 27,65	79
<b>Listino</b>	RA1/2VX10	10	26,20 €	€ 261,95	
29,11 €	RA1/2VX20	20	24,89 €	€ 497,71	
	RA1/2VX50	50	23,58 €	€1.178,79	



Rubinetto Biuso 1/2"  
Tiziana P.

Codice	Cod. Off.	Pz	Prezzo	Costo tot.	D.
RBPT	RBPT	1	23,13 €	€ 23,13	282
<b>Listino</b>	RBPTX3	3	21,91 €	€ 65,74	
24,35 €	RBPTX6	6	20,82 €	€ 124,91	
	RBPTX9	9	19,72 €	€ 177,51	



Rubinetto Sing.C/Aeratore 1/2"

Codice	Cod. Off.	Pz	Prezzo	Costo tot.	D.
RAT	RAT	1	23,94 €	€ 23,94	253
<b>Listino</b>	RATx10	10	22,68 €	€ 226,80	
25,20 €	RATx20	20	21,55 €	€ 430,92	
	RATx50	50	20,41 €	€1.020,60	



Rubinetto Singolo 1/2" S /P Tiz.

Codice	Cod. Off.	Pz	Prezzo	Costo tot.	D.
RT	RT	1	21,30 €	€ 21,30	407
<b>Listino</b>	RTX10	10	20,18 €	€ 201,80	
22,42 €	RTX20	20	19,17 €	€ 383,41	
	RTX50	50	18,16 €	€ 908,08	



Rubinetto Vitone Rapido D. 1/2" Cromato Idral  
L€ Scheda Tecnica»



Codice	Cod. Off.	Pz	Prezzo	Costo tot.	D.
RVRLC1/2	RVRLC1/2	1	17,51 €	€ 17,51	429
<b>Listino</b>	RVRLC1/2X3	3	16,58 €	€ 49,75	
18,43 €	RVRLC1/2X5	6	15,76 €	€ 94,53	
	RVRLC1/2X9	9	14,93 €	€ 134,34	



Rubinetto Artistico 1/2"  
Sfera

Codice	Cod. Off.	Pz	Prezzo	Costo tot.	D.
RA1/2S	RA1/2S	1	28,73 €	€ 28,73	36
<b>Listino</b>	RA1/2SX10	10	27,22 €	€ 272,16	
30,24 €	RA1/2SX20	20	25,86 €	€ 517,10	



Rubinetto Diritto  
Da 1/2 Con  
Rompigetto  
Cromo

Codice	Prezzo	Rif.	Off. Pubbico
667	11,85 €	1	10,37 €
667X10	11,23 €	10	9,82 €



Rubinetto Sfera  
Pes. 1/2"" Leva  
Alluminio Nera

Codice	Prezzo	Rif.	Off. Pubbico
2050N015	8,24 €	6	7,21 €
2050N015X12	7,36 €	12	6,44 €



Rubinetto Sfera  
Pesante Leva  
Blu

Codice	Prezzo	Rif.	Off. Pubbico
RS1\2P	9,60 €	1/2"	8,40 €
RS3\4P	12,60 €	3/4"	11,02 €

Rubinetto A Sfera Da 1/2""



Codice	Prezzo	Rif.	Off. Pubbico
RS1\2	5,21 €	6	4,55 €
RS1\2X12	5,05 €	12	4,42 €

Rubinetto A Sfera 3/4"" Levazz



Codice	Prezzo	Rif.	Off. Pubbico
RS3\4	8,19 €	6	7,17 €
RS3\4X12	7,95 €	12	6,95 €

Rubinetto A Sfera 1" Leva



Codice	Prezzo	Rif.	Off. Pubbico
RS1	13,85 €	6	12,12 €
RS1X12	13,43 €	12	11,75 €

Rubinetto G. Da 1/2" Lucido



Codice	Prezzo	Rif.	Off. Pubbico
RGP1\2	17,56 €		15,37 €

Rubinetto Giallo C /Estr. Port.



Codice	Prezzo	Rif.	Off. Pubbico
RGCE1\2	10,53 €		9,21 €

Rubinetto Pulsante Fontana



Codice	Prezzo	Rif.	Off. Pubbico
RPFGL	25,36 €	1	22,19 €
RPFGLx10	24,02 €	10	21,02 €

Rubinetto A "T" X Lav.1/2"X3/4"



Codice	Prezzo	Rif.	Off. Pubbico
RTL	7,00 €	1	6,12 €
RTL5	6,53 €	5	5,71 €

Rubinetto A Sfera Doppio Portagomma



Codice	Prezzo	Rif.	Off. Pubbico
2040ST015	12,83 €		11,23 €

Rubinetto A Sfera 1/2"" P /Lucch.



Codice	Prezzo	Rif.	Off. Pubbico
RS1\2L	7,53 €		6,59 €

Rubinetto Sfera Lavatrice Pesante  
Misura D. 1/2"X3/4"



Codice	Prezzo	Rif.	Off. Pubbico
RSLP	6,16 €		5,39 €

Rubinetto Sfera Lavatrice standard  
Misura D. 1/2"X3/4"



Codice	Prezzo	Rif.	Off. Pubbico
RSL	5,99 €		5,24 €

Rubinetto Sfera Lavatrice Bibo Misura D.  
1/2"X3/4"



Codice	Prezzo	Rif.	Off. Pubbico
RSLB	7,30 €		6,39 €



Flussometro Inc. Da 3/4"  
Cr.

Codice	Cod. Off.	Prezzo	Pz	Off. Pubbico	D.
F3\400	D. 3/4"	42,50 €	10	€ 37,19	192
F100	D. 1"	47,32 €	10	€ 41,41	141



Piastra Passo Rapido In  
Ottone Cromato H10X28  
Mm 87X135

Codice	Cod. Off.	Pz	Prezzo	Costo tot.	D.
2912F04	2912F04	1	3,71 €	€ 3,71	336
<b>Listino</b>	2912F04X5	5	3,51 €	€ 17,55	
	2912F04X10	10	3,34 €	€ 33,35	
	2912F04X15	15	3,16 €	€ 47,40	



Placca Inox Per  
Flussometro

Codice	Cod. Off.	Pz	Prezzo	Costo tot.	D.
PIF	PIF	1	0,92 €	€ 0,92	3034
<b>Listino</b>	PIFX5	5	0,87 €	€ 4,34	
	PIFX10	10	0,82 €	€ 8,24	
	PIFX15	15	0,78 €	€ 11,71	



Blister Vitoni Rubinetto

Codice	Cod. Off.	Pz	Prezzo	Costo tot.	D.
090BVU	090BVU	1	9,28 €	€ 9,28	46
<b>Listino</b>	090BVUX5	5	8,79 €	€ 43,94	
	090BVUX10	10	8,35 €	€ 83,49	
	090BVUX15	15	7,91 €	€ 118,64	



Tubo Telescopico  
Flussometro Esterno Da  
3/4" D. 25 Cromo

Codice	Riferimenti	Prezzo	Pz	Off. Pubbico	D.
TTF3\4E00	D. 3/4"	18,37 €	10	€ 16,07	18
TTF1E00	D. 1"	23,02 €	10	€ 20,14	0



Flussometro Esterno 3/4"  
Cr.

Codice	Cod. Off.	Prezzo	Pz	Off. Pubbico	D.
FE3\400	D. 3/4"	42,10 €	10	€ 36,83	129
FE100	D. 1"	44,03 €	10	€ 38,53	1

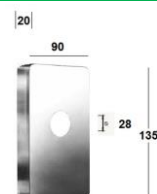

Piastra Passo Rapido In  
Ottone Cromato H20X28  
Mm 87X135

Codice	Cod. Off.	Pz	Prezzo	Costo tot.	D.
2912F07	2912F07	1	4,52 €	€ 4,52	518
<b>Listino</b>	2912F07X5	5	4,29 €	€ 21,43	
	2912F07X10	10	4,07 €	€ 40,72	
	2912F07X15	15	4,07 €	€ 61,08	



Rosone X Fluss. Tondo  
20X25

Codice	Cod. Off.	Pz	Prezzo	Costo tot.	D.
RFT20X25	RFT20X25	1	2,26 €	€ 2,26	630
<b>Listino</b>	2912F04X5	5	3,51 €	€ 17,55	
	2912F04X10	10	3,34 €	€ 33,35	
	2912F04X15	15	3,16 €	€ 47,40	



#N/D

Codice	Cod. Off.	Pz	Prezzo	Costo tot.	D.
091BUF	091BUF	1	30,97 €	€ 30,97	87
<b>Listino</b>	091BUFX5	5	29,34 €	€ 146,71	
	091BUFX10	10	27,88 €	€ 278,75	
	091BUFX15	15	26,41 €	€ 396,12	



Vitone passo rapido  
completo di maniglia

Codice	Riferimenti	Prezzo	Pz	Off. Pubbico	D.
VF26H33	D. 26	27,05 €	10	€ 23,67	177
VF27H33	D. 27	22,57 €	10	€ 19,75	387
VF28H33	D. 28	24,35 €	10	€ 21,30	14
VF29H33	D. 29	22,57 €	10	€ 19,75	95
VF30H33	D. 30	23,03 €	10	€ 20,15	164





Bocca Di Erogazione A Parete Attacco 3/4" Con Deviatore 1/2"

Codice	Cod. Off.	Pz	Prezzo	Costo tot.	D.
BEPDG00	BEPDG00	1	76,20 €	€ 76,20	49
<b>Listino</b>	BEPDG00X5	5	72,58 €	€ 362,88	
90,72 €	BEPDG00X10	10	68,95 €	€ 689,47	
	BEPDG00X15	15	63,50 €	€ 952,56	



Bocca Di Erogazione Parete 3/4"

Codice	Cod. Off.	Pz	Prezzo	Costo tot.	D.
BEPG00	BEPG00	1	57,15 €	€ 57,15	49
<b>Listino</b>	BEPG00X5	5	54,43 €	€ 272,16	
68,04 €	BEPG00X10	10	51,71 €	€ 517,10	
	BEPG00X15	15	47,63 €	€ 714,42	



Canna Alta Ombrello D.24 H 280X230

Codice	Cod. Off.	Pz	Prezzo	Costo tot.	D.
HY-G2402	HY-G2402	1	13,92 €	€ 13,92	14
<b>Listino</b>	HY-G2402X5	5	13,18 €	€ 65,91	
14,65 €	HY-G2402X10	10	12,52 €	€ 125,24	
	HY-G2402X15	15	11,86 €	€ 177,97	

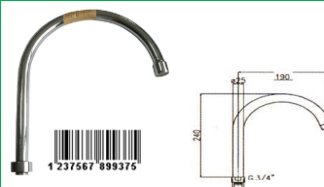

Canna Alta A Tubo Per Lavabo Da Mm Da 230X190 Mm Girevole

Codice	Cod. Off.	Pz	Prezzo	Costo tot.	D.
HY-G2403	HY-G2403	1	12,66 €	€ 12,66	29
<b>Listino</b>	HY-G2403X5	5	11,99 €	€ 59,96	
13,32 €	HY-G2403X10	10	11,39 €	€ 113,92	
	HY-G2403X15	15	10,79 €	€ 161,89	



Canna Alta A Tubo Per Lavabo Da Mm Da 220X170 Mm Girevole

Codice	Cod. Off.	Pz	Prezzo	Costo tot.	D.
HY-G2404	HY-G2404	1	10,05 €	€ 10,05	80
<b>Listino</b>	HY-G2404X5	5	9,53 €	€ 47,63	
10,58 €	HY-G2404X10	10	9,05 €	€ 90,49	
	HY-G2404X15	15	8,57 €	€ 128,60	



Canna Univ. Jota 3/4"X20

Codice	Cod. Off.	Pz	Prezzo	Costo tot.	D.
CJU20	CJU20	1	7,38 €	€ 7,38	0
<b>Listino</b>	CJU20X5	5	6,99 €	€ 34,96	
7,77 €	CJU20X10	10	6,64 €	€ 66,42	
	CJU20X20	15	6,29 €	€ 94,38	



Canna Telescopica D. 18 Est. Da 200 A 300 Mm

Codice	Cod. Off.	Pz	Prezzo	Costo tot.	D.
I-09500SE	I-09500SE	1	30,00 €	€ 30,00	36
<b>Listino</b>	I-09500SEX5	5	28,42 €	€ 142,12	
31,58 €	I-09500SEX10	10	27,00 €	€ 270,03	
	I-09500SEX15	15	25,58 €	€ 383,72	



Canna Universale Cm. 20 Con Bocca Orientabile

Codice	Cod. Off.	Pz	Prezzo	Costo tot.	D.
CBR20	CBR20	1	6,34 €	€ 6,34	27
<b>Listino</b>	CBR20X5	5	6,01 €	€ 30,05	
6,68 €	CBR20X10	10	5,71 €	€ 57,10	
	CBR20X15	15	5,71 €	€ 85,65	



Canna Lav. Univ."U"Cr 18X20

Codice	Cod. Off.	Pz	Prezzo	Costo tot.	D.
CUU20	CUU20	1	7,62 €	€ 7,62	98
<b>Listino</b>	CUU20X5	5	7,22 €	€ 36,08	
8,02 €	CUU20X10	10	6,85 €	€ 68,54	
	CUU20X15	15	6,49 €	€ 97,40	



Canna Univ. 3/4 X 20Cm.

Codice	Cod. Off.	Pz	Prezzo	Costo tot.	D.
CUE20	CUE20	1	6,92 €	€ 6,92	402
<b>Listino</b>	CUE20X5	5	6,55 €	€ 32,77	
7,28 €	CUE20X10	10	6,23 €	€ 62,27	
	CUE20X15	15	5,90 €	€ 88,49	

Colonna Doccia El.Jet Nero



Codice	Prezzo	Rif.	Off. Pubbico
CEJNE	607,26 €	1	531,35 €
CEJNEX2	546,53 €	2	478,21 €

Colonna Doccia Magicconfort



Codice	Prezzo	Rif.	Off. Pubbico
CDMC	74,42 €	1	65,12 €
27598001X5	65,71 €	5	57,50 €

Saliscendi Cromato Per Doccia Serie Tempesta Grohe



Codice	Prezzo	Rif.	Off. Pubbico
27598001	70,40 €	1	61,60 €
27598001X5	65,71 €	5	57,50 €

Saliscendi Completo Dalia



Codice	Prezzo	Rif.	Off. Pubbico
DALIA	34,02 €		29,77 €
DALIA X5	30,62 €	5	26,79 €

Saliscendi Asta Ellittica Con Portasapone E Doccetta



Codice	Prezzo	Rif.	Off. Pubbico
KANDY	45,93 €		40,19 €
KANDY X5	43,09 €	5	37,71 €

Braccio & Soffione Doccia agganciabile in tutte le Aste saliscendi D. 24/25



Codice	Prezzo	Rif.	Off. Pubbico
59910	17,01 €		14,88 €
59910 X5	15,31 €	5	13,40 €

Saliscendi Lilia Completa

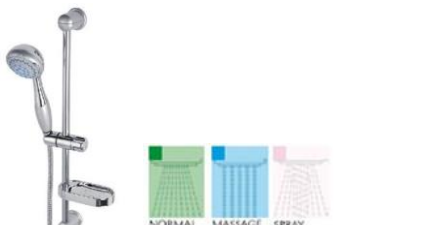

Codice	Prezzo	Rif.	Off. Pubbico
LILIA	34,02 €		29,77 €
LILIA X5	30,62 €	5	26,79 €

New Saliscendi Docc.5 Getti Con Porta Sapone



Codice	Prezzo	Rif.	Off. Pubbico
ROSY	28,35 €		24,81 €
ROSY X5	25,52 €	5	22,33 €

Saliscendi Europa 4 Getti Cr.



Codice	Prezzo	Rif.	Off. Pubbico
SE4GC	24,10 €		21,09 €
SE4GC X5	21,69 €	5	18,98 €

Set Doccia Cromo Palinuro



Codice	Prezzo	Rif.	Off. Pubbico
110E84100	32,13 €		28,11 €
110E84100X2	30,24 €	2	26,46 €

Set Doccia Cromo Ischia



Codice	Prezzo	Rif.	Off. Pubbico
110E36100	22,76 €		19,91 €
110E36100X5	21,42 €	5	18,74 €

Saliscendi Magic Confort Senza Asta Regolabile



Codice	Prezzo	Rif.	Off. Pubbico
SMC4GC	31,42 €		27,49 €
SMC4GC X5	29,77 €	5	26,05 €

Braccio Doccia Lusso Sezione Quadrata In Scatola



Codice	Prezzo	Rif.	Off. Pubbico
BD6042003CR	63,70 €		55,74 €
BD6042003CR X5	57,33 €	5	50,17 €

Braccio Doccia Lusso Cm.35



Codice	Prezzo	Rif.	Off. Pubbico
BD6048CR35	68,45 €		59,89 €
BD6048CR35 X5	61,60 €	5	53,90 €

Saliscendi NEOS Doccia AMBRA in abs 4 funzioni



Codice	Prezzo	Rif.	Off. Pubbico
SL5N420T5CR	45,36 €		39,69 €
SL5N420T5CR X5	40,82 €	5	35,72 €



Braccio Doccia Sphera  
6037

Codice	Riferimenti	Prezzo	Pz	Off. Pubbico	D.
BD6037253CR	cm. 25	12,25 €	10	€ 10,72	476
BD6037303CR	cm. 30	14,03 €	5	€ 12,28	217
BD6037403CR	cm. 40	15,31 €	5	€ 13,40	359



Braccio Doccia a Tubo  
Import senza rosetta

Codice	Riferimenti	Prezzo	Pz	Off. Pubbico	D.
DGO-08525	cm. 25	5,67 €	10	€ 4,96	100
DGO-08630	cm. 30	5,67 €	10	€ 4,96	5
DGO-08735	cm. 35	5,67 €	10	€ 4,96	169
	cm. 40		5		

Import Export

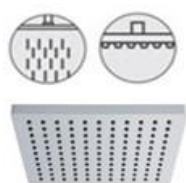

Soffione Derby 20X20



Codice	Riferimenti	Prezzo	Pz	Off. Pubbico	D.
SD4914	20 cm	28,68 €	5	€ 25,09	4
SD4924	25 cm	64,67 €	5	€ 56,58	10
SD4934	30 cm	86,89 €	5	€ 76,03	10



Soffioni Inox  
Anticalcare Quadrati

Codice	Riferimenti	Prezzo	Pz	Off. Pubbico	D.
S-1040Q	10x10	5,39 €	5	€ 4,71	0
S-1540Q	15x15	11,34 €	5	€ 9,92	3
S-2040Q	20x20	17,01 €	5	€ 14,88	5
S-2540Q	25x25	25,52 €	5	€ 12,76	0

Import Export



Soffione Tondo  
20X20 Chelsea



Codice	Riferimenti	Prezzo	Pz	Off. Pubbico	D.
SD3922	20 cm	20,16 €	5	€ 17,64	1
SD3925	25 cm	42,91 €	5	€ 37,55	7
SD3930	30 cm	65,86 €	5	€ 57,63	9



Soffioni Inox  
Anticalcare Tondo

Codice	Riferimenti	Prezzo	Pz	Off. Pubbico	D.
S-1040T	10x10	5,67 €	5	€ 4,96	1
S-1540T	15x15	11,34 €	5	€ 9,92	11
S-2040T	20x20	17,01 €	5	€ 14,88	0
S-2540T	25x25	25,52 €	5	€ 12,76	0

Import Export

Duplex Glamour Fisso



Codice	Prezzo	Rif.	Off. Pubbico
DP3064	35,04 €		30,66 €
DP3064X5	31,54 €	5	27,59 €

Duplex Arte Fisso



Codice	Prezzo	Rif.	Off. Pubbico
DP3052	31,87 €		27,88 €
DP3052X5	28,68 €	5	25,09 €

RUIS12

Rubinetto per idroscopino in ottone 1/2



Codice	Prezzo	Rif.	Off. Pubbico
RUIS12	21,26 €		18,60 €
RUIS12X5	19,14 €	5	16,74 €

Doccia Parrucchiere 2 Getti



Codice	Prezzo	Rif.	Off. Pubbico
DC5003	16,57 €		14,50 €

Doccia Trendy Monoget.Antic.Linea  
Minimale Quadrato



Codice	Prezzo	Rif.	Off. Pubbico
DC5056001CR	16,16 €		14,14 €

Doccia Star Monoget.Antic.Tonda



Codice	Prezzo	Rif.	Off. Pubbico
DC5039	14,41 €		12,61 €



Kit Braccio Doccia Con Soffione Serie Lux



**FLEXTON**

Codice	Prezzo	Rif. Off. Pubbico
4010CR	30,24 €	26,46 €

Kit Braccio Doccia Con Soffione Serie Lux



**FLEXTON**

Codice	Prezzo	Rif. Off. Pubbico
4001CR	30,24 €	26,46 €

Kit Braccio Doccia Con Soffione Serie Lux Anticalcare



**FLEXTON**

Codice	Prezzo	Rif. Off. Pubbico
4002CR	30,24 €	26,46 €

Kit Braccio Doccia Con Soffione Serie Lux Maxi Perfecta



**FLEXTON**

Codice	Prezzo	Rif. Off. Pubbico
4003CR	30,24 €	26,46 €

Doccetta Retta Monogetto serie tradizionale



Codice	Prezzo	Rif. Off. Pubbico
DREB	2,70 €	5 2,37 €
DREN	2,70 €	5 2,37 €

DOCcETTA DOCCIA CON CURVETTA PER FORCELLA CLASSICA



Codice	Prezzo	Rif. Off. Pubbico
DCEN	3,29 €	2,88 €

Doccia Kit Marine Cromo In Scatola Idromassaggio



Art. DCKITM MARINE  
3 getti in ABS cromato

Codice	Prezzo	Rif. Off. Pubbico
DCKITM	11,58 €	10,13 €

Doccetta Primula Cromo Ant.



Codice	Prezzo	Rif. Off. Pubbico
D1GC	2,24 €	1,96 €

Doccetta Aurora



Codice	Prezzo	Rif. Off. Pubbico
AURORA	6,55 €	5,73 €

Doccia Shut Off Con Fermo Leva Nera



Codice	Prezzo	Rif. Off. Pubbico
DC5035N	4,48 €	3,92 €

Doccia Salome'



Codice	Prezzo	Rif. Off. Pubbico
DC5009	20,05 €	17,55 €

Doccia Aladino Shut Off



Codice	Prezzo	Rif. Off. Pubbico
DC5028	3,80 €	3,32 €

Gomito Saliscendi Mm 1/2" C.Ros



Codice	Prezzo	Rif. Off. Pubbico
GS1\2	1,87 €	1,64 €

Preso acqua in ottone serie Glamour attacco 1/2" MM



Codice	Prezzo	Rif. Off. Pubbico
PA3160003CR	4,34 €	3,80 €

Preso acqua in ottone modello Arte attacco 1/2" MM



Codice	Prezzo	Rif. Off. Pubbico
PA3150003CR	4,34 €	3,80 €

Duplex Esterno Abs



Codice	Prezzo	Rif.	Off. Pubbico
DP3033	1,08 €		0,94 €

Duplex Esterno Forcellino



Codice	Prezzo	Rif.	Off. Pubbico
DP3036	4,14 €		3,63 €

Duplex Esterno Fuso



Codice	Prezzo	Rif.	Off. Pubbico
DP3034	5,72 €		5,00 €

Flessibile doccia FF semplice attaccatura



Codice	Prezzo	Rif.	Off. Pubbico
FD150	3,08 €	150	2,70 €
FD200	4,35 €	200	3,81 €

Flex Doccia 150 Conico



Codice	Prezzo	Rif.	Off. Pubbico
FD150C	3,68 €	150	3,22 €
FD200C	4,54 €	200	3,97 €

Flex Monoforo 120 Conico 1/2" Cono 3/8" Maschio



Codice	Prezzo	Rif.	Off. Pubbico
FM120C	5,04 €	120	4,41 €

Flessibile doccia FF semplice attaccatura



Codice	Prezzo	Rif.	Off. Pubbico
S1GA	4,55 €		3,98 €

Soffione Standard 1/2"



Codice	Prezzo	Rif.	Off. Pubbico
SS	5,57 €		4,87 €

Flex Doccia Estensibile Scatola 150-200 Conico



Codice	Prezzo	Rif.	Off. Pubbico
FDE200S	6,91 €	120	6,04 €

Soffione A Campana Anticalcare



Codice	Prezzo	Rif.	Off. Pubbico
SD4075	7,23 €		6,33 €

Soffione Idromassaggio Muoltigettti Easyclean Pesante Cromato Lucido



**FLEXTON**

Codice	Prezzo	Rif.	Off. Pubbico
0893CR	10,58 €		9,26 €

Soffione Idromassaggio Muoltigettti Pesante Cromato Lucido



**FLEXTON**

Codice	Prezzo	Rif.	Off. Pubbico
0892CR	9,58 €		8,38 €

Soffione Magic Anticalcare



Codice	Prezzo	Rif.	Off. Pubbico
SD4072	4,28 €		3,75 €

Soffione Ninfea 3 Getti Anticalcare Cromato



Codice	Prezzo	Rif.	Off. Pubbico
SD4062	14,87 €		13,01 €

Soffione Gardenia 5 Getti



**SPHERA**  
DOCCIE & ACCESSORI

Codice	Prezzo	Rif.	Off. Pubbico
SD4020	8,82 €		7,72 €

Cestino Carol Triplo Cromato



Codice	Prezzo	Rif. Off. Pubbico
ACC13142	15,12 €	13,23 €

Cestino Carol Doppio Cromato



Codice	Prezzo	Rif. Off. Pubbico
ACC13141	12,60 €	11,03 €

Cestino Carol Singolo Cromato



Codice	Prezzo	Rif. Off. Pubbico
ACC13140	10,08 €	8,82 €

SHOWER LOCK ANGOLARE DOCCIA  
TRIPLO SATINATO



Codice	Prezzo	Rif. Off. Pubbico
101D14101	35,64 €	31,18 €

Angoliera Melanie Doppia Cromato



Codice	Prezzo	Rif. Off. Pubbico
ACC13146	12,60 €	11,03 €

Angoliera Melanie Singola Cromato



Codice	Prezzo	Rif. Off. Pubbico
ACC13150	10,08 €	8,82 €

Cestello Grip

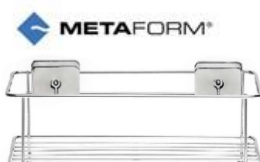

Codice	Prezzo	Rif. Off. Pubbico
105G94100	20,59 €	18,01 €

Angolare Doccia Bianco Oasi



Codice	Prezzo	Rif. Off. Pubbico
101C17004	8,06 €	7,06 €

Angolare Doccia Grip



Codice	Prezzo	Rif. Off. Pubbico
105G96100	24,39 €	21,34 €

Set Accessori Bagno Metaform Serie  
Otto/One



Codice	Prezzo	Rif. Off. Pubbico
101757100	84,42 €	73,87 €

Kit Wind 4 Pezzi Cromo



Codice	Prezzo	Rif. Off. Pubbico
105L23100	47,88 €	41,90 €

Kit Wind 8 Pezzi Cromo



Codice	Prezzo	Rif. Off. Pubbico
101L02100	90,72 €	79,38 €

Porta Scopino Da Terra Cromo



Codice	Prezzo	Rif. Off. Pubbico
101118100	11,84 €	10,36 €

Kit Linea 9 Pezzi Bianco



Codice	Prezzo	Rif. Off. Pubbico
101331004	60,48 €	52,92 €

Kit Linea 4 Pezzi Cromo



Codice	Prezzo	Rif. Off. Pubbico
110A46100	45,36 €	39,69 €



Asciugacapelli Da Parete One Bia





Codice	Prezzo	Rif.	Off. Pubbico
101906004	42,84 €		37,49 €

Asciugamani Elettrico Rocket Bianco  
1800 W



Codice	Prezzo	Rif.	Off. Pubbico
LFHD1E	67,50 €		59,06 €

Seggiolino Vasca Con Schenale  
Regolabile In Larghea



Codice	Prezzo	Rif.	Off. Pubbico
15500	209,79 €	1	183,57 €
15500X2	209,79 €	2	183,57 €

Sgabello 4 Gambe Bianco



Codice	Prezzo	Rif.	Off. Pubbico
101H47602	47,88 €		41,90 €

Seduta Ribaltabile Da Muro In Alluminio  
Verniciato E Materiale Plastico Bianco



Codice	Prezzo	Rif.	Off. Pubbico
101M52004	78,12 €		68,36 €

Seduta Per Vasca Regolabile Bianco



Codice	Prezzo	Rif.	Off. Pubbico
101H48602	124,69 €		109,10 €

Lavabo Ergonomico Disabilis/Troppo  
Pieno





Codice	Prezzo	Rif.	Off. Pubbico
10192	155,27 €	1	135,86 €
10192X2	140,48 €	2	122,92 €

Vaso Disabile Scarico Terra





Codice	Prezzo	Rif.	Off. Pubbico
10200	155,21 €	1	135,81 €
10200X2	140,43 €	2	122,88 €

Sedile Ribaltabile Thermomat Saniline A  
Parete



Codice	Prezzo	Rif.	Off. Pubbico
T-SPR	223,51 €	1	195,57 €
T-SPRX2	198,68 €	2	173,84 €

Vaso Alto Terza Eta' Scarico Pavimento  
Age





Codice	Prezzo	Rif.	Off. Pubbico
10381	165,73 €	Vaso	145,01 €
10386	165,73 €	Bidet	145,01 €

Vaso Disabile Sc.Parete





Codice	Prezzo	Rif.	Off. Pubbico
10210	155,21 €	1	135,81 €
10210X2	140,43 €	2	122,88 €

Mensola Reclinabile Lavabo Art. 15101



Codice	Prezzo	Rif.	Off. Pubbico
15101	99,04 €		86,66 €

Specchio Basculante Bianco



Codice	Prezzo	Rif.	Off. Pubbico
101H21004	140,24 €	1	122,71 €
101H21004x2	133,56 €	2	116,87 €

Mensola Pneumatica Reclinabile Art.  
15102





Codice	Prezzo	Rif.	Off. Pubbico
15102	200,04 €	1	175,03 €

Coppia Mensole Fisse Lavabo Art. 15100





Codice	Prezzo	Rif.	Off. Pubbico
15100	44,19 €		38,66 €

Miscelatore A Due Pedali Per Montaggio A Pavimento.



Codice	Prezzo	Rif.	Off. Pubbico
M2PPI	126,30 €	1	110,51 €
M2PPIX5	117,88 €	5	103,14 €

Miscelatore Progressivo Monopedale Per Installazione A Pavimento



Codice	Prezzo	Rif.	Off. Pubbico
MPPI	125,34 €	1	109,67 €
MPPIX5	116,98 €	5	102,36 €

Miscelatore a pedale temporizzato a parete/pavimento Self-closing pedal wall-

PEDALE MISCELATORE / PEDAL MIXER



Codice	Prezzo	Rif.	Off. Pubbico
9010	157,95 €		138,21 €

Rubinetto a pedale temporizzato a parete/pavimento Self-closing pedal wall-

PEDALE MONOACQUA / PEDAL SINGLE-WATER TAP



101free

Codice	Prezzo	Rif.	Off. Pubbico
9057	62,87 €		55,01 €

Rubinetto a pedale temporizzato a parete/pavimento Self-closing pedal wall-

PEDALE MONOACQUA / PEDAL SINGLE-WATER TAP



101free



Codice	Prezzo	Rif.	Off. Pubbico
9056	92,55 €		80,98 €

Miscelatore a pedale istantaneo a parete/pavimento Instantaneous pedal

PEDALE ISTANTANEO / INSTANTANEOUS-FLOW PEDAL TAP



101free



Codice	Prezzo	Rif.	Off. Pubbico
9011	69,80 €		61,07 €

Miscelatore lavabo elettronico con canna girevole con alimentazione a batteria

LAVELLO MISCELATORE / SINK MIXER



101free

Codice	Prezzo	Rif.	Off. Pubbico
7091SB	390,22 €		341,44 €

Rubinetto lavabo elettronico con alimentazione a batteria Electronic basin tap

LAVABO / BASIN TAP



101free

Codice	Prezzo	Rif.	Off. Pubbico
7035B	253,57 €		221,87 €

Rubinetto miscelatore per lavabo, a comando

LAVABO / BASIN TAP



101free

Codice	Prezzo	Rif.	Off. Pubbico
703601	290,42 €		254,12 €

Rubinetto lavabo temporizzato Self-closing basin tap Robinet lavabo

LAVABO MONOACQUA / BASIN SINGLE WATER TAP



101free



Codice	Prezzo	Rif.	Off. Pubbico
9001	52,72 €		46,13 €

Miscelatore lavabo temporizzato Self-closing basin mixer Mitigeur lavabo

LAVABO MISCELATORE / BASIN MIXER



101free



Codice	Prezzo	Rif.	Off. Pubbico
9007	87,70 €		76,74 €

Bocca Erogazione Mon. Ec. C / T.



Codice	Prezzo	Rif.	Off. Pubbico
BEMEI	32,57 €		28,50 €
BEMEIX5	28,95 €		25,34 €

Flussometro ad incasso studiato per il colpo d'ariete, per installazione a parete

FLUSSOMETRO INCASSO / BUILT-IN FLUSH VALVE

101free



Codice	Prezzo	Rif.	Off. Pubbico
9455G	76,97 €		67,34 €

Pre-miscelatore completo di valvola di non ritorno Pre-mixer complete with



101free



Codice	Prezzo	Rif.	Off. Pubbico
9020ECO	25,08 €		21,94 €

Bocca Erogazione Mon. Ec. C / T.



Codice	Prezzo	Rif.	Off. Pubbico
BEMEI	32,57 €		28,50 €
BEMEIX5	28,95 €		25,34 €

Bocca Di Erogazione Lavabo Fissa



**idral**  
UNIQUE PARTNER FOR WATER SOLUTIONS

Codice	Prezzo	Rif.	Off. Pubbico
02026	30,94 €		27,07 €
02026X5	29,12 €		25,48 €

Idroscopino Att/Muro Idral Cr.



**idral**  
UNIQUE PARTNER FOR WATER SOLUTIONS

Codice	Prezzo	Rif.	Off. Pubbico
02420C	134,95 €		118,08 €
02420CX5	127,01 €		111,13 €

Bocca fissa per lavabo, installazione a parete.  
Connessione gambo filettato maschio G 1/2



BOCCA PER LAVABO /  
BASIN SPOUT



Codice	Prezzo	Rif.	Off. Pubbico
901300	52,04 €		45,54 €
901300x2	48,98 €		42,86 €

Maniglione Acciaio Inox 30Cm Lucido



**METAFORM®**

Codice	Prezzo	Rif.	Off. Pubbico
105H08100	27,31 €	1	23,90 €
105H08100X5	25,70 €	5	22,49 €

Maniglione Acciaio Inox 45 Cm Lucido



**METAFORM®**

Codice	Prezzo	Rif.	Off. Pubbico
105H09100	28,38 €	1	24,83 €
105H09100X5	26,71 €	5	23,37 €

Maniglione Acciaio Inox 60 Cm Lucido



**METAFORM®**

Codice	Prezzo	Rif.	Off. Pubbico
105H10100	32,13 €	1	28,11 €
105H10100X5	30,24 €	5	26,46 €

Maniglione Acciaio Bianco 30Cm Bianco



**METAFORM®**

Codice	Prezzo	Rif.	Off. Pubbico
105H08004	18,74 €	1	16,40 €
105H08004X5	17,64 €	5	15,44 €

Maniglione Acciaio Bianco 45Cm Bianco



**METAFORM®**

Codice	Prezzo	Rif.	Off. Pubbico
105H09004	22,22 €	1	19,45 €
105H09004X5	20,92 €	5	18,30 €

Maniglione Acciaio Bianco 60 Cm Bianco



**METAFORM®**

Codice	Prezzo	Rif.	Off. Pubbico
105H10004	24,90 €	1	21,79 €
105H10004X5	23,44 €	5	20,51 €

Dispenser Genius Sanificante



Guarda Video



Codice	Prezzo	Rif.	Off. Pubbico
GNS20NX	208,18 €	2	182,16 €

Maniglione Lineare Cm. 30 Verniciato Bianco Idral



Codice	Prezzo	Rif.	Off. Pubbico
12000V-30	23,94 €	30	20,95 €
12000V-50	31,02 €	50	27,14 €

Barra D'Appoggio Ribaltabile 70 Cm Bianco



**METAFORM®**

Codice	Prezzo	Rif.	Off. Pubbico
101H12004	55,44 €	1	48,51 €
101H12004X2	55,44 €	2	48,51 €

Dispenser Per Sapone A Muro D. 22x8x7 cm.



Codice	Prezzo	Rif.	Off. Pubbico
748665	4,96 €		4,34 €
748665X5	4,67 €		4,09 €

Dispenser X Sapone A Muro 2 pulsanti D. 21x15x7



Codice	Prezzo	Rif.	Off. Pubbico
748666	7,72 €		6,76 €
748666X2	7,27 €		6,36 €

Dispenser X Sapone Schiumogeno A Batteria



Codice	Prezzo	Rif.	Off. Pubbico
TX-9730	13,86 €		12,13 €



Tubo Doccia 80 X 80 Bianco



Codice	Prezzo	Conf.	Off. Pubbico
110715002	12,10 €	6	10,58 €

Hk Tenda Doccia Mod. Hello 180X200Cm



Codice	Prezzo	Conf.	Off. Pubbico
HLK00TD0HLL00	8,38 €	6	7,33 €

Hk Tenda Doccia Mod. Sweet 180X200Cm



Codice	Prezzo	Conf.	Off. Pubbico
HLK00TD0SWT00	8,38 €	6	7,33 €



Codice	Prezzo	Conf.	Off. Pubbico
645362	7,26 €	6	6,35 €



Codice	Prezzo	Conf.	Off. Pubbico
645363	7,66 €	6	6,70 €



Codice	Prezzo	Conf.	Off. Pubbico
645364	7,26 €	6	6,35 €

Rialzo Per Seduta Wc Bianco



Codice	Prezzo	Rif.	Off. Pubbico
101H13004	34,81 €	1	30,46 €
101H13004X5	32,76 €	5	28,67 €

Sedile Wc Bianco Sedile For Life



Codice	Prezzo	Rif.	Off. Pubbico
101E77004	32,13 €	1	28,11 €
101E77004X5	30,24 €	5	26,46 €

Sedile Wc Airbag Toilet Seat Airbag - Abattant Wc Airbag



Codice	Prezzo	Rif.	Off. Pubbico
101B44004	20,88 €	1	18,27 €
101B44004X5	19,66 €	5	17,20 €

Sedile Wc Bianco Aretusa Fit



Codice	Prezzo	Rif.	Off. Pubbico
101F59004	32,13 €	1	28,11 €
101F59004X5	30,24 €	5	26,46 €

Sedile Wc Fit-Series Sintesi 2.0



Codice	Prezzo	Rif.	Off. Pubbico
101F98004	32,13 €	1	28,11 €
101F98004X5	30,24 €	5	26,46 €

Sedile Pesante Universale Bianco Economico



Codice	Prezzo	Rif.	Off. Pubbico
SPUBO	25,97 €	1	22,73 €
SPUBOX5	24,44 €	5	21,39 €

SEDILE WC FIT-SERIES TESI



Codice	Prezzo	Rif.	Off. Pubbico
101E72004	32,13 €	1	28,11 €
101E72004X5	30,24 €	5	26,46 €

SEDILE WC FIT-SERIES CONCA



Codice	Prezzo	Rif.	Off. Pubbico
101E71004	32,13 €	1	28,11 €
101E71004X5	30,24 €	5	26,46 €

Sedile Wc Economico Bianco Rs-3370

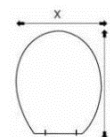

X ⇔ 37  
Y ⇔ 45  
Z ⇔ 15

Codice	Prezzo	Rif.	Off. Pubbico
SMEB	10,40 €	1	9,10 €
SMEBX5	9,79 €	5	8,57 €

Sedile Wc Hello Kitty Universale Cerniera  
In Nylon Regolabile



Codice	Prezzo	Rif.	Off. Pubbico
SWCHKH2501101	12,76 €	1	11,16 €
SWCHKH25011015	10,84 €	5	9,49 €

Copriwater Termoindurente Rosso Zz



X ⇄ 37  
Y ⇄ 45  
Z ⇄ 15

Codice	Prezzo	Rif.	Off. Pubbico
SHR	16,07 €	1	14,06 €
SHRX5	15,12 €	5	13,23 €

Copriwater Termoindurente Verde  
Acqua Zz



X ⇄ 37  
Y ⇄ 45  
Z ⇄ 15

Codice	Prezzo	Rif.	Off. Pubbico
SHVA	16,07 €	1	14,06 €
SHVAX5	15,12 €	5	13,23 €

Coppia Cerniere Copriwater Universale  
Alette 61 Mm 68 Mm Import



Codice	Prezzo	Rif.	Off. Pubbico
DGO-156	5,99 €		5,24 €

Coppia Cerniere Copriwater Universale  
Alette 54 Mm 57 Mm Import



Codice	Prezzo	Rif.	Off. Pubbico
DGO-157	5,99 €		5,24 €

Supporto Sedile Pesante Universale  
Cromato



Codice	Prezzo	Rif.	Off. Pubbico
SSP	5,62 €		4,92 €

Kit Cerniere Pesante cromato.  
Completo:



Codice	Prezzo	Rif.	Off. Pubbico
KSSU	9,24 €		8,08 €
KSSU10	8,69 €	10	7,61 €

Kit Cerniere Pesante cromato.  
Completo:



Codice	Prezzo	Rif.	Off. Pubbico
KSSUC	7,36 €		6,44 €
KSSUC10	6,93 €	10	6,06 €

Supporto Sedile Sovrapposta



Codice	Prezzo	Rif.	Off. Pubbico
SSS	12,05 €		10,54 €
SSS10	11,34 €	10	9,92 €

Supporto Sedile Pesante Un. Barra



Codice	Prezzo	Rif.	Off. Pubbico
SSPU	9,64 €		8,43 €
SSPU5	9,07 €	5	7,94 €

Supporto Sedile Espansione



Codice	Prezzo	Rif.	Off. Pubbico
SSE	14,73 €		12,89 €
SSE10	13,86 €	10	12,13 €

Kit Cerniera ricambio in Acciaio Inox



Codice	Prezzo	Rif.	Off. Pubbico
52880	8,03 €		7,03 €
5288010	7,56 €	10	6,62 €

Supporto X Sedile Viti Zincati



Codice	Prezzo	Rif.	Off. Pubbico
SSMVZ	0,81 €		0,71 €
SSMVZ25	0,76 €	25	0,67 €

Supporto Moplen Pvc



Codice	Prezzo	Rif.	Off. Pubbico
SSM	0,59 €		0,52 €
SSM25	0,55 €	25	0,49 €

Set Paracolpi Sedili Termoind.



Codice	Prezzo	Rif.	Off. Pubbico
SATSP	1,45 €		1,27 €
SATSP25	1,36 €	25	1,19 €

**universale**

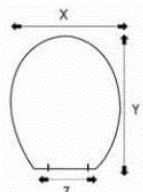



Sat 1 Copriwater  
Termoindurente

X ⇨ 37  
Y ⇨ 45  
Z ⇨ 15

 Prezzo Unitario

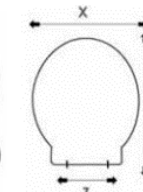
Codice	Riferimenti	Prezzo	Off. Pubbico	Conf.	Box
SAT1		19,15 €	16,76 €	1	12





Sat 1 Copriwater  
Termoidurente Zz

X ⇨ 37,5  
Y ⇨ 42,5  
Z ⇨ 18

 Prezzo Unitario

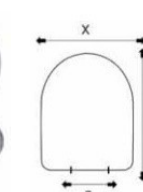
Codice	Riferimenti	Prezzo	Off. Pubbico	Conf.	Box
SAT2		37,11 €	32,47 €	1	12





Sat 3 Copriwater  
indurente Aretusa

X ⇨ 37  
Y ⇨ 45,5  
Z ⇨ 18

 Prezzo Unitario

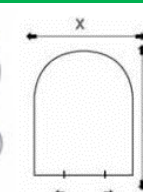
Codice	Riferimenti	Prezzo	Off. Pubbico	Conf.	Box
SAT3		37,11 €	32,47 €	1	12





Sat 4 Copriwater  
Termoindurente

X ⇨ 37  
Y ⇨ 45  
Z ⇨ 18

 Prezzo Unitario

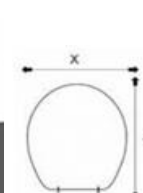
Codice	Riferimenti	Prezzo	Off. Pubbico	Conf.	Box
SAT4		37,11 €	32,47 €	1	12





Sat 5 Copriwater  
Zztermoindurente

X ⇨ 39  
Y ⇨ 45,5  
Z ⇨ 15

 Prezzo Unitario

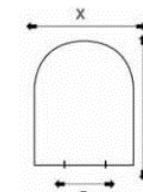
Codice	Riferimenti	Prezzo	Off. Pubbico	Conf.	Box
SAT5		37,11 €	32,47 €	1	12

Sat 6 Copriwater  
Termoindurente  
Sintesi

X ⇨ 35  
Y ⇨ 44,5  
Z ⇨ 18

 Prezzo Unitario

Codice	Riferimenti	Prezzo	Off. Pubbico	Conf.	Box
SAT6		37,11 €	32,47 €	1	12





Sat 7 Copriwater  
Termoindurente Zz

X ⇨ 35,5  
Y ⇨ 45,5  
Z ⇨ 16,5

 Prezzo Unitario

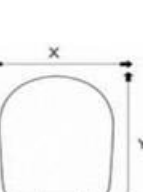
Codice	Riferimenti	Prezzo	Off. Pubbico	Conf.	Box
SAT7		56,26 €	49,23 €	1	12



Sat 8 Copriwater  
Termoindurente Zz

X ⇨ 35,5  
Y ⇨ 45,5  
Z ⇨ 17,5

 Prezzo Unitario

Codice	Riferimenti	Prezzo	Off. Pubbico	Conf.	Box
SAT8		58,65 €	51,32 €	1	12

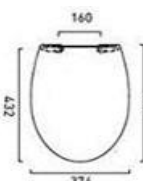
Sedile Soft Close Satsu Universale Slim

 Prezzo Unitario

Codice	Riferimenti	Prezzo	Off. Pubbico	Conf.	Box
SATSU		35,91 €	31,42 €	1	12

Sat 9 Sedile  
Termoindurente Zz

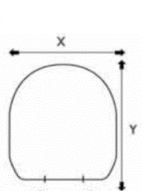
X ⇨ 35,5  
Y ⇨ 39,5  
Z ⇨ 16



 Prezzo Unitario

Codice	Riferimenti	Prezzo	Off. Pubbico	Conf.	Box
SAT9		68,23 €	59,70 €	1	12

Sedile Soft Close Sat10 Zz

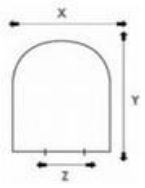
X ⇨ 36  
Y ⇨ 45,5  
Z ⇨ 17



 Prezzo Unitario

Codice	Riferimenti	Prezzo	Off. Pubbico	Conf.	Box
SAT10		68,23 €	59,70 €	1	12

Sedile Soft Close Sat11 Zz

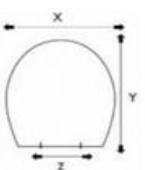
X ⇨ 36,5  
Y ⇨ 44  
Z ⇨ 14,5



 Prezzo Unitario

Codice	Riferimenti	Prezzo	Off. Pubbico	Conf.	Box
SAT11		58,65 €	51,32 €	1	12



Sedile Soft Close Sat12  
Full 48 Zz

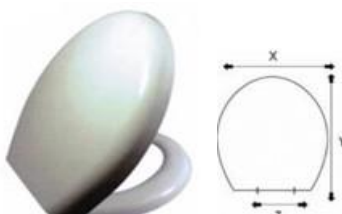

X ⇨ 37  
Y ⇨ 45  
Z ⇨ 18

 **Prezzo Unitario**

Codice	Riferimenti	Prezzo	Off. Pubbico	Conf.	Box
SAT12		65,36 €	57,19 €	1	12

Sedile Soft Close Sat 18  
Zz



X ⇨ 36,5  
Y ⇨ 40  
Z ⇨ 13

 **Prezzo Unitario**

Codice	Riferimenti	Prezzo	Off. Pubbico	Conf.	Box
SAT18		68,23 €	59,70 €	1	12

Sedile Soft Close Sat13  
Zz

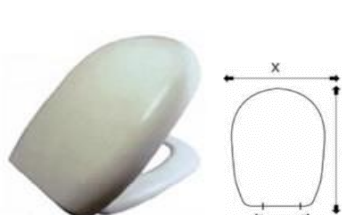

X ⇨ 36  
Y ⇨ 47,5  
Z ⇨ 14

 **Prezzo Unitario**

Codice	Riferimenti	Prezzo	Off. Pubbico	Conf.	Box
SAT13		65,36 €	57,19 €	1	12

Sedile Soft Close Sat 19  
Zz



X ⇨ 35,2  
Y ⇨ 46  
Z ⇨ 18

 **Prezzo Unitario**

Codice	Riferimenti	Prezzo	Off. Pubbico	Conf.	Box
SAT19		69,43 €	60,75 €	1	12

Sedile Soft Close Sat14  
Zz

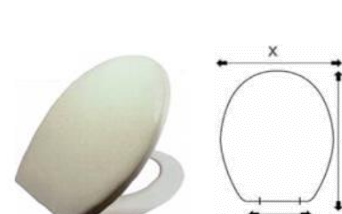

X ⇨ 37,5  
Y ⇨ 44  
Z ⇨ 14

 **Prezzo Unitario**

Codice	Riferimenti	Prezzo	Off. Pubbico	Conf.	Box
SAT14		67,03 €	58,65 €	1	12

Sedile Soft Close Sat 20  
Zz



X ⇨ 36  
Y ⇨ 48,5  
Z ⇨ 18

 **Prezzo Unitario**

Codice	Riferimenti	Prezzo	Off. Pubbico	Conf.	Box
SAT20		68,23 €	59,70 €	1	12

Sedile Soft Close Sat 15  
Zz

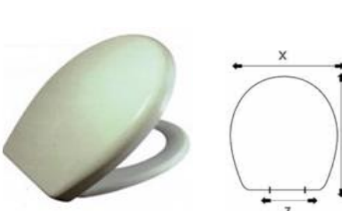

X ⇨ 37  
Y ⇨ 44  
Z ⇨ 14

 **Prezzo Unitario**

Codice	Riferimenti	Prezzo	Off. Pubbico	Conf.	Box
SAT15		59,85 €	52,37 €	1	12

Sedile Soft Close Sat 21  
Zz



X ⇨ 36,5  
Y ⇨ 46,5  
Z ⇨ 14

 **Prezzo Unitario**

Codice	Riferimenti	Prezzo	Off. Pubbico	Conf.	Box
SAT21		68,23 €	59,70 €	1	12

Sedile Soft Close Sat16  
Zz



X ⇨ 36,5  
Y ⇨ 45,5  
Z ⇨ 17

 **Prezzo Unitario**

Codice	Riferimenti	Prezzo	Off. Pubbico	Conf.	Box
SAT16		69,43 €	60,75 €	1	12

Sedile Soft Close Sat 22  
Zz



X ⇨ 37  
Y ⇨ 44  
Z ⇨ 14

 **Prezzo Unitario**

Codice	Riferimenti	Prezzo	Off. Pubbico	Conf.	Box
SAT22		68,23 €	59,70 €	1	12

Sedile Soft Close Sat17  
Zz

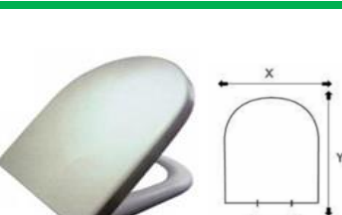

X ⇨ 36  
Y ⇨ 42  
Z ⇨ 17,5

 **Prezzo Unitario**

Codice	Riferimenti	Prezzo	Off. Pubbico	Conf.	Box
SAT17		69,43 €	60,75 €	1	12

Sedile Termoidurente  
Per Disabile Soft Close



X ⇨ 37  
Y ⇨ 44  
Z ⇨ 14

 **Prezzo Unitario**

Codice	Riferimenti	Prezzo	Off. Pubbico	Conf.	Box
SAT23		68,23 €	59,70 €	1	12

**Sedile Termoindurente Soft Close SAT 24**

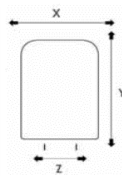

X ⇄ 35  
Y ⇄ 43  
Z ⇄ 19



**Prezzo Unitario**

Codice	Riferimenti	Prezzo	Off. Pubbico	Conf.	Box
SAT24		54,94 €	48,08 €	1	12

**Sedile Termoindurente Soft Close SAT 26**

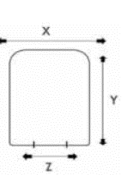

X ⇄ 35  
Y ⇄ 43  
Z ⇄ 19



**Prezzo Unitario**

Codice	Riferimenti	Prezzo	Off. Pubbico	Conf.	Box
SAT25		54,94 €	48,08 €	1	12

**Sedile Termoindurente Soft Close SAT 26**

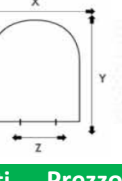

X ⇄ 36  
Y ⇄ 45,5  
Z ⇄ 17



**Prezzo Unitario**

Codice	Riferimenti	Prezzo	Off. Pubbico	Conf.	Box
SAT26		54,94 €	48,08 €	1	12

**Ricerca Per Azienda e Modello**

Casa	Serie	Sat
Althea	Centro slow close	11
	Fly slow close	11
	Hola	5-14
	Hola Sospeso	5
	Marion	3-16
	Ring	6-19
	Sky	1
	Smart	4-10
Astra	Gemma	6-19
Axa	Axa One slow close	17
	Axa 2	4-10
	Cilvia Cilvia Sospeso	6-19
Azzurra	Afrodite	6-19
	Diana	6-13
	Elios - Elios Plus	6-19
	Frine	6
	Ful 48	2-12
	Full 54	12
	Full 56	5-14
	Giove	1
	Giunone	2
	Jubileaeum	2
	Midas	6-19
	Mini Nuvola Quadrato	17
	Mini Nuvola Tondo	9
	Nuvola	6-10



**Kit Cerniera Odeon horizont OD**

**Kit Cerniera Odeon Espansione ED**

**Kit Cerniera Zero Ø**

**Kit Cerniera Expa Plast EP**

**Kit Cerniera Revival R**

**Kit Cerniera Expo E**

**Kit Cerniera Plastica P**

**Kit Cerniera Goccia G**

**Set Paracolpi per sintesi**

**Set Paracolpi**

**Codice Riferimenti Prezzo Off. Pubbico Conf. Box**

SATCP	Kit Cerniere In Plastica	8,38 €	7,33 €	1	12
SATCZ	Kit Cerniera Zero	14,36 €	12,57 €	1	12
SATCE	Kit Cerniera Expo	17,96 €	15,71 €	1	12
SATCR	Kit Cerniera Revival	14,36 €	12,57 €	1	12
SATCH	Kit Cerniera Horizont	16,76 €	14,66 €	1	12

**Ricerca Per Azienda e Modello**

Casa	Serie	Sat	Casa	Serie	Sat
Azzurra	Pratica	6-19		Mid	2
	New Light	19		Sintesi - System	6-19
Catalano	C 52	4-10	Cielo	Ares Astra	6
	C 54	4-10		Celia	6-19
	Canova	22		Easybath	2-12
	Luce	14		Ermes - Euro	1
	Neve	3		Easy/Evo	2-12
	Neve Sfera	3-16	Cielo	Euro	11
	Sistema C 52	4-10	Cielo	Florence	3-16
Cesabo	Elte	1-14		Lara	1-11
	Eridurance	6-19		Medea	3-16
	Exel	1-11	Cielo	Mithos	2
	Kris	4-10		Smile	4-10
Cesame	Aretusa Aretusa MB	3-13	Delta	Trevi	2
	Aretusina	6-19	Disegno Ceramica	Giulia	6-19
	Belle Epoque	22		Paolina	2
	Fenice	21	Dolomite	Alpina	19

Casa	Serie	Sat	Casa	Serie	Sat	Casa	Serie	Sat
	Clodia	3-16	Hatria	Daytime	4-10		Oxa	6-19
	Petra	16		Dolce Vita	4		Fly	1-14
	Quadrarco	19		Erika	1-14		Letizia	6-19
	Tenax	15		Marylin	3-16		Serena	1-14
	Suite	25	Hidra	Pluvia	3-16	Pozzi Ginori	Colibri - Colibri 2	15
Duravit	Happy D	4-10		Roma	1		Kim	1
Eos	Astra	3-16		Smarty	12		Linea	6
	Clio	6-19		Top Line	16		Monte Bianco	2
	Mistral	6-19		Pegaso	16		Novecento	20
	Punto / Punto Sospeso	3-16	House	Prima	5		Panda	18
Esedra	Esè - Mix	6-19	Ideal Standard	Conca	7		Quinta	5
	Poing	12		Esedra	4-14		Seinova 3	3-19
	Bull	6-19		Fiorile	3-16		Ydra	3-16
Etruria	Alba	3		Tesi	8		Fantasia 2	24
Faleri	Adria - Adria Sospeso	3-13	Incea	Hide	11	Rak	Orient	8
	Duelta . F30	9		Joe	15		S 50	17
	Fish	5-14		Laura	4-10		Metropolitan	24
	Foglia	6-19		Nube	6-19		Compac1	3-13
	Magica	5-14		Opi	1-14		Moon	4-10
Flaminia	Fidia	16		Piuma	6-19	Roca	Giralda	3
	Link	4-10		Supra	15		Polo	18
	Metro Metro MB	3-16	Jumbo	Aretona	13		Polo Sopeso	6-19
	Mini Link	17		Ego	9		Tipo	17
	Pompei	1		Tua	3-16		Victoria	18
	Relax	6-19	Kerasan	Europa	1		Debba	25
G.S.I	Clizia	5-14		Flo	4	Sanisuda	Alta	3-16
	Essenza	5-11		Flo 48	17		Aveiro	6-19
	Havant	3-16		Flo 52	10		City	4-10
	Traccia	25		Godia	3-16	Scala	Gemma	15
	Xenia	6-19		Volant	2	Scic	Donna	16
	City	11	Laufen	Dino	6-19	Senesi	Pienza	6
	Pura	4-10		Harmony	3		Donatello	15
Galassia	Agorà	6-19	Nero Ceramica	Aliseo	20	Simas	Arcade	18
	Aster	3-16		Classic	3		Eline	4-10
	Ethos	2		Genesi	6-19		Europa	3-16
	Ola	1-14		Iceberg	11		Flow	2
	M2 55	6		Yesterday	5		Londra	2
	M2 45/55	9-19		Skil	15	Vavid	Orientale	3
	Piuma	19		Round	6-19			
Globo	Alia	3-16	Olympia	Federica	3-16	Veliero	Colombo	3-16
	Arianna	1-14		Impero	2		Colombo 2	6-19
	Bonsai	12		Merkur	5-14		Odissea	6-19
	Flavia	3-16		Nicole	4-10		Tirreno	3-16
	Grace	6-19		Rubino	3-16		Valentina	3
	Lei	5-14		Serie 92	6-19	Vitra	S20	25
Globo	Misura	3-16		Vela	3		Zentrum	17
	Open Space	4-10	Opera Sanitari	Area	24	Vitruvit	Armonia	3-16
	Pestum	2		Aida	6-19		Young	6-19
Globo	Bowl	6-19		Venere	26			
Gravenia	Derby	1		Narcisia	4-19			
	Garbo - Garbo MB	3		Zero	4-10			
	Giada	6-19		Saly	6-19			
	Jenny	1-14		Onda	3-16			
Hatria	Cannes	1		Young	6-19			



Sifone Moplen 2 V. 11/2" Magnum Tutto 11/2"



Codice	Prezzo	Rif.	Off. Pubbico
S2V11\2M	4,89 €		4,28 €

Sifone Moplen 1 V. 11/2" Magnum Tutto 11/2"



Codice	Prezzo	Rif.	Off. Pubbico
S1V11\2M	3,51 €		3,07 €

Sifone Lavello Autopulente A 1 Via 11/2" S/Piletta



Codice	Prezzo	Rif.	Off. Pubbico
S11V11\2	8,68 €		7,59 €

Sifone 2 Vie 11/4" S/Pilette



Codice	Prezzo	Rif.	Off. Pubbico
S2V11\4	2,86 €		2,50 €

Sifone 2 Vie 11/4" Con Pilette



Codice	Prezzo	Rif.	Off. Pubbico
S2V11\4C	9,22 €		8,07 €

Sifone Industriale 2 Vie 11/2"



Codice	Prezzo	Rif.	Off. Pubbico
SI2V11\2	12,50 €		10,93 €

Sifone 1 Via Moplen Da 11/4" Con Piletta



Codice	Prezzo	Rif.	Off. Pubbico
S1V11\4C	4,71 €		4,12 €

Piletta Gattinara 11/4" Ottone



Codice	Prezzo	Rif.	Off. Pubbico
PG11\4	7,94 €		6,95 €

Piletta Ø70 Uscita Laterale Tappo Manigl. Ø52 + Tubo Comp



Codice	Prezzo	Rif.	Off. Pubbico
D502E	2,97 €		2,60 €

Piletta Gattinara 11/2" Tropp. Man. G. 18/8 D. 70 + Gr.



Codice	Prezzo	Rif.	Off. Pubbico
PGM11\2T	6,29 €	Rett	5,50 €
PGM11\2TT	5,80 €	Tondi	5,07 €

Piletta Gattinara Moplen 11/2" Tappo E Catena



Codice	Prezzo	Rif.	Off. Pubbico
PGM11\2	3,28 €		2,87 €

Raccordo Retto 11/4"X40 Arag.



Codice	Prezzo	Rif.	Off. Pubbico
RR11\4X40A	3,67 €		3,21 €

Piletta Canestro 90 C/Tp Tondo



Codice	Prezzo	Rif.	Off. Pubbico
PGMG11\2TT	13,58 €	tondo	11,88 €
PGMG11\2TR	13,58 €	Rett.	11,88 €

Piletta Moplen Gigante 11/2"-90



Codice	Prezzo	Rif.	Off. Pubbico
PGMG11\2	10,03 €		8,78 €

Piletta Ø114 Modello Classic Brillante, Tp Rotondo Rigido



Codice	Prezzo	Rif.	Off. Pubbico
D577-36E	8,00 €	tondo	7,00 €
D590E	6,46 €	Rett.	5,66 €

Piletta Ø65 Modello Click Clack, Sifone Autopul. Ø32 + Eccentrico Ø32XØ40



Codice	Prezzo	Rif.	Off. Pubbico
SLI004-33E	22,39 €		19,59 €

Piletta Ø65 Modello Orion, Sifone Autopul. Ø32 + Eccentrico Ø32XØ40



Codice	Prezzo	Rif.	Off. Pubbico
SOR004-33E	15,83 €		13,85 €

Piletta Doccia Plastica Bianca C/Tappo Cromato Est 90X60 Foro



Codice	Prezzo	Rif.	Off. Pubbico
PDSP90HD40	5,42 €	90	4,75 €
PDSP120HD40	8,33 €	120	7,29 €

Sifone Per Vasca Da Bagno Orientabile Con Uscita G1½

**Sifone Per Vasca Da Bagno Orientabile Con Uscita D. 1½**



Codice	Prezzo	Rif.	Off. Pubbico
DS9000651E	1,86 €	11/2"	1,62 €

Piletta Doccia Splash 11/2" P80



Codice	Prezzo	Rif.	Off. Pubbico
PDM11\2S	15,36 €		13,44 €

Piletta Doccia Sc.Fil.D40 D.120 Cr.



Codice	Prezzo	Rif.	Off. Pubbico
5290AB12S7	14,81 €		12,96 €

Pilettoni Pila 11/4"



Codice	Prezzo	Rif.	Off. Pubbico
PP11\4	17,20 €	11/4"	15,05 €

Piletta Doccia Turboflow 90 Bianco



Codice	Prezzo	Rif.	Off. Pubbico
TBFLOXS	47,91 €		41,92 €

Piletta Doccia Da 11/4" Sifoide



Codice	Prezzo	Rif.	Off. Pubbico
PD11\4	9,07 €	11/4"	7,94 €

Riduzione Bianca F/M 11/4X1" - 11/2"x11/4"



Codice	Prezzo	Rif.	Off. Pubbico
PRMHBH	0,25 €	11/4x1	0,22 €
PRMHDHB	0,25 €	11/2x11/4	0,22 €

Riduzione Bianca F/M 11/4X11/2"



Codice	Prezzo	Rif.	Off. Pubbico
ARMHBHD	0,17 €	11/2x11/4	0,15 €

Piletta Doccia Pozzetto Pes.



Codice	Prezzo	Rif.	Off. Pubbico
PDP11\4	16,38 €	11/4"	14,33 €

Cestello Inox X Level.Pil Baskzz



Codice	Prezzo	Rif.	Off. Pubbico
CLBI	5,31 €		4,65 €

Griglietta Per Lavelli Inox



Codice	Prezzo	Rif.	Off. Pubbico
GLI	0,54 €		0,48 €

Filtro per Lavello D. 11,3



Codice	Prezzo	Rif.	Off. Pubbico
79537	2,02 €	11,3	1,76 €



Cestello Scattino D.80 Inox



Codice	Prezzo	Rif.	Off. Pubbico
SCATTINO	3,72 €		3,26 €

Tappo Saltarello Copripiletta Da 1"1/4



Codice	Prezzo	Rif.	Off. Pubbico
TP114CP	4,54 €		3,97 €

Snodino Doppio In Ottone Cr.



Codice	Prezzo	Rif.	Off. Pubbico
SDO	2,02 €		1,76 €

Tap Grill Il Nuovo Tappo A Griglia Raccogli Rifiuti



Codice	Prezzo	Rif.	Off. Pubbico
TAPGRILL	3,35 €		2,93 €

Tappo Saltarello Vasca Universale



Codice	Prezzo	Rif.	Off. Pubbico
TPSVU	5,04 €		4,41 €

Snodino Nylon Econ.



Codice	Prezzo	Rif.	Off. Pubbico
SNE	0,26 €		0,22 €

Sifone Arredo Tondo Da 1"1/4



Codice	Prezzo	Rif.	Off. Pubbico
SIFT	28,91 €		25,29 €

Cestello Univ.X Pil.Autom 11/4



Codice	Prezzo	Rif.	Off. Pubbico
NSHB00	6,17 €		5,40 €

Snodino Semplice In Ottone Cr.



Codice	Prezzo	Rif.	Off. Pubbico
SSO	0,76 €		0,66 €

Sifone Arredo Quadro Da 1"1/4



Codice	Prezzo	Rif.	Off. Pubbico
SIFQZ	39,56 €	Cromo	34,62 €

Colonna Scarico Vasca 11/2"



Codice	Prezzo	Rif.	Off. Pubbico
CVA00	44,10 €	Cromo	38,59 €
CVAC00	49,61 €	Clk Clak	43,41 €

Colonna Vasca Aut. 11/2" Bronzo



Codice	Prezzo	Rif.	Off. Pubbico
CVA47	58,06 €	Bronzo	50,80 €



Piletta Click Clack Universale Quadrata Zz

Codice	Prezzo	Rif.	Off. Pubbico
PCUQ	23,81 €	Cromo	20,84 €



Piletta Click Clack Universale D. 1"1/4

Codice	Prezzo	Rif.	Off. Pubbico
PCU	18,52 €	Cromo	16,21 €



Colonna Vasca Automatica Bian.

Codice	Prezzo	Rif.	Off. Pubbico
CVA04	38,10 €	Bianca	33,34 €



Sifone A Esse 1"



Codice	Prezzo	Rif.	Off. Pubbico
SE1	15,61 €	1"	13,66 €
SE11\4	15,82 €	11/4"	13,84 €

Sifone A Bottiglia 1"



Codice	Prezzo	Rif.	Off. Pubbico
SB1	14,95 €	1"	13,08 €
SB11\4	17,20 €	11/4"	15,05 €

Prolunga Ridotta Cromata 11/4" F X1" M  
Zz Ex Prc11/4X1



Codice	Prezzo	Rif.	Off. Pubbico
PROCHBH	5,14 €		4,49 €
PROCHDHB	5,14 €		4,49 €

Piletta Norton Tappo Leggero Da 1"



Codice	Prezzo	Rif.	Off. Pubbico
PNEH	6,30 €	1"	5,51 €
PNEHB	7,01 €	11/4"	6,13 €

Piletta Da 1" Pesante



Codice	Prezzo	Rif.	Off. Pubbico
PNLH	12,45 €	1"	10,89 €
PNLHB	12,45 €	11/4"	10,89 €

Asta Piletta Norton Zz



Codice	Prezzo	Rif.	Off. Pubbico
APN	1,38 €		1,20 €

Tappo Piletta Norton 1" Pvc



Codice	Prezzo	Rif.	Off. Pubbico
TPN1	1,89 €	1"	1,65 €
TPN11\4	1,89 €	11/4"	1,65 €

Tappo Piletta 1" Pesanti



Codice	Prezzo	Rif.	Off. Pubbico
TPNOCH	3,78 €	1"	3,31 €
TPNOCHB	3,78 €	11/4"	3,31 €

Kit Asta Per Saltarello



Codice	Prezzo	Rif.	Off. Pubbico
TPAST00000	1,67 €		1,46 €



Estensibile Ghiera Metallo D.  
1"X32

Codice	Riferimenti	U.M.	Busta	Box	Prezzo
SFLEXH32	1X32	PZ	10	100	1,508 €
SFLEXHB32	11/4X32	PZ	10	100	1,580 €
SFLEXHD40	11/2X40	PZ	10	100	1,365 €



Estensibile Cromato D.  
1"X32

Codice	Riferimenti	U.M.	Busta	Box	Prezzo
SFLEXDH32	1X32	PZ	10	100	3,591 €
SFLEXDHB32	11/4X32	PZ	10	100	4,118 €
SFLEXDHD40	11/2X40	PZ	10	100	2,844 €
SFLEXDHD4050	11/2X4050	PZ	10	100	2,844 €



Estensibile Spiraleto Anima  
In Acciaio D. 1"X26 D.40

Codice	Riferimenti	U.M.	Busta	Box	Prezzo
SFLEXCH26	1X26	PZ	10	100	5,913 €
SFLEXCH32	1X32	PZ	10	100	5,913 €
SFLEXCHB32	11/4X32	PZ	10	100	5,913 €
SFLEXCHD32	11/2X32	PZ	10	100	5,913 €
SFLEXCHD40	11/2X40	PZ	10	100	5,913 €
SFLEXCHB40	11/4X40	PZ	10	100	5,913 €



Estensibile 1"X26 Bonomini

Codice	Riferimenti	U.M.	Busta	Box	Prezzo
E1X26B	1X26	PZ	10	100	1,276 €
E1X32B	1X32	PZ	10	100	1,520 €
E11\4X32B	11/4X32	PZ	10	100	1,451 €
E11\2X40B	11/2X40	PZ	10	100	1,424 €

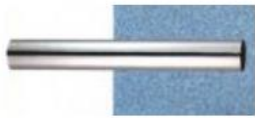

Art. 300 Canotto in ottone cromato

Codice	Riferimenti	U.M.	Busta	Box	Prezzo
30026X25	26x25 mm	PZ	10	100	3,255 €
30026X30	26x30 mm	PZ	10	100	3,788 €
30030X25	30x25 mm	PZ	10	100	3,788 €
30030X30	30x30 mm	PZ	10	100	4,400 €
30032X25	32x25 mm	PZ	10	100	4,003 €
30032X30	32x30 mm	PZ	10	100	4,649 €
30040X25	40x25 mm	PZ	10	100	3,052 €
30040X30	40x30 mm	PZ	10	100	3,465 €
30026X100	26x100 mm	PZ	5	25	5,988 €
30030X100	30x100 mm	PZ	5	25	14,016 €
30032X100	32x100 mm	PZ	5	25	15,490 €
30040X100	40x100 mm	PZ	5	25	11,068 €



Art. 303 Canotto flessibile in rame cromato

Codice	Riferimenti	U.M.	Busta	Box	Prezzo
30326X25	26x25 cm	PZ	10	100	6,577 €
30326X30	26x30 cm	PZ	10	100	7,132 €
30330X25	30x25 cm	PZ	10	100	2,994 €
30330X30	30x30 cm	PZ	10	100	7,791 €
30332X25	32x25 cm	PZ	10	100	6,883 €
30332X30	32x30 cm	PZ	10	100	7,994 €

**PIASTRA PASSO RAPIDO TONDA OTTONE**



[Visualizza la gamma completa](#)

Codice	Riferimenti	U.M.	Busta	Box	Prezzo
2911P25	25 mm	PZ	10	100	4,536 €
2911P28	28 mm	PZ	10	100	4,491 €



Rosone per canotto D. esterno D. 75

Codice	Riferimenti	U.M.	Busta	Box	Prezzo
ROC00	L77XH14	PZ	10	100	1,016 €



Rosetta Larga Da 1/2" Cm. 7 Ottone Cromato

Codice	Riferimenti	U.M.	Busta	Box	Prezzo
RL12		PZ	10	100	0,493 €



Art. 301 Canotto con battuta in ottone cromato

Codice	Riferimenti	U.M.	Busta	Box	Prezzo
30126X25	26x25 mm	PZ	10	100	3,289 €
30126X30	26x30 mm	PZ	10	100	3,833 €
30130X25	30x25 mm	PZ	10	100	2,419 €
30130X30	30x30 mm	PZ	10	100	4,479 €
30132X25	32x25 mm	PZ	10	100	4,048 €
30132X30	32x30 mm	PZ	10	100	4,695 €
30140X25	40x25 mm	PZ	10	100	3,226 €
30140X30	40x30 mm	PZ	10	100	8,952 €



Art. 305 Canotto 45° per cassette alta con tubo incassato

Codice	Riferimenti	U.M.	Busta	Box	Prezzo
305C30x24	30X240	PZ	10	100	4,788 €
305C30x28	30X280	PZ	10	100	5,443 €
305C30X32	30X320	PZ	10	100	6,199 €



Rosone per canotto D. esterno D. 75

Codice	Riferimenti	U.M.	Busta	Box	Prezzo
R2600	D. 26 cromo	PZ	10	100	0,488 €
R3000	D. 30 cromo	PZ	10	100	0,483 €
R3200	D. 32 cromo	PZ	10	100	0,469 €
R4000	D. 40 cromo	PZ	10	100	0,826 €



Rosetta Biella 1/2" Cromo

Codice	Riferimenti	U.M.	Busta	Box	Prezzo
R1\200		PZ	100	1.000	0,428 €



Rosetta Inox Foro Esagonale

Codice	Riferimenti	U.M.	Busta	Box	Prezzo
2906ID		PZ	10	100	0,227 €



Rosone Acciaio Inox 1/2"

Codice	Riferimenti	U.M.	Busta	Box	Prezzo
2900ID		PZ	10	100	0,227 €



Codice	Riferimenti	U.M.	Busta	Box	Prezzo
A1\2X25	1/2" X25	PZ	10	100	4,789 €
A1\2X30	1/2" X30	PZ	10	100	5,080 €
A1\2X35	1/2" X35	PZ	10	100	5,371 €
A1\2X40	1/2" X40	PZ	10	100	5,689 €
A1\2X50	1/2" X50	PZ	10	100	6,297 €



Codice	Riferimenti	U.M.	Busta	Box	Prezzo
A3\4X25	3/4" X25	PZ	10	100	5,662 €
A3\4X30	3/4" X30	PZ	10	100	7,620 €
A3\4X35	3/4" X35	PZ	10	100	6,245 €
A3\4X40	3/4" X40	PZ	10	100	8,573 €
A3\4X40	3/4" X50	PZ	10	100	8,573 €



Codice	Riferimenti	U.M.	Busta	Box	Prezzo
A1X25	1" X25	PZ	10	100	8,573 €
A1X30	1" X30	PZ	10	100	11,378 €
A1X35	1" X35	PZ	10	100	9,314 €
A1X40	1" X40	PZ	10	100	11,622 €
A1X50	1" X50	PZ	10	100	13,389 €



Codice	Riferimenti	U.M.	Busta	Box	Prezzo
A11\4X25	1 1/4" X25	PZ	10	100	16,694 €
A11\4X30	1 1/4" X30	PZ	10	100	18,421 €
A11\4X35	1 1/4" X35	PZ	10	100	17,920 €
A11\4X40	1 1/4" X40	PZ	10	100	21,459 €
A11\4X50	1 1/4" X50	PZ	10	100	24,546 €

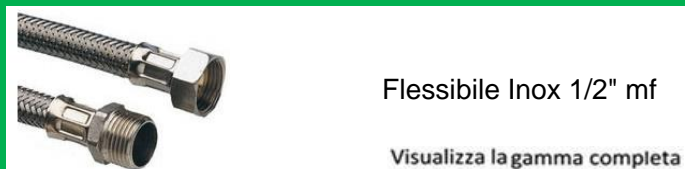

Codice	Riferimenti	U.M.	Busta	Box	Prezzo
FI25	1/2" X25	PZ	10	100	3,086 €
FI30	1/2" X30	PZ	10	100	2,064 €
FI35	1/2" X35	PZ	10	100	2,929 €
FI40	1/2" X40	PZ	10	100	3,072 €
FI50	1/2" X50	PZ	10	100	2,328 €

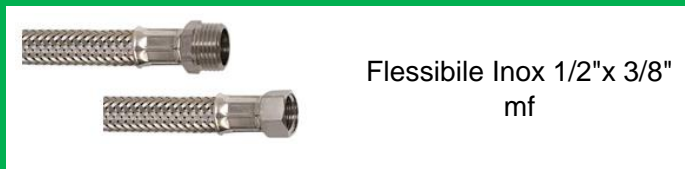

Codice	Riferimenti	U.M.	Busta	Box	Prezzo
FI3\8X25	1/2x3/8x25	PZ	10	100	2,643 €
FI3\8X30	1/2x3/8x30	PZ	10	100	2,117 €
FI3\8X35	1/2x3/8x35	PZ	10	100	2,929 €
FI3\8X40	1/2x3/8x40	PZ	10	100	3,072 €
FI3\8X50	1/2x3/8x50	PZ	10	100	2,646 €

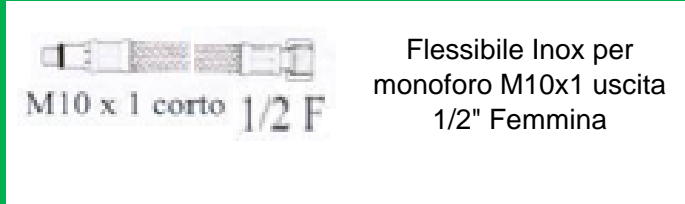

Codice	Riferimenti	U.M.	Busta	Box	Prezzo
FM25	U. 1/2" F CM. 25	PZ	10	100	2,762 €
FM30	U. 1/2" F CM. 30	PZ	10	100	2,877 €
FM35	U. 1/2" F CM. 35	PZ	10	100	2,302 €

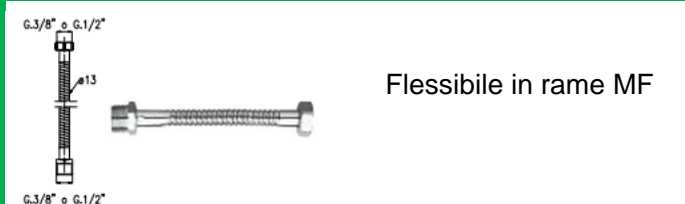

Codice	Riferimenti	U.M.	Busta	Box	Prezzo
FR25	1/2" X25	PZ	10	100	2,829 €
FR30	1/2" X30	PZ	10	100	2,943 €
FR35	1/2" X35	PZ	10	100	3,067 €
FR40	1/2" X40	PZ	10	100	3,725 €
FR50	1/2" X50	PZ	10	100	3,848 €

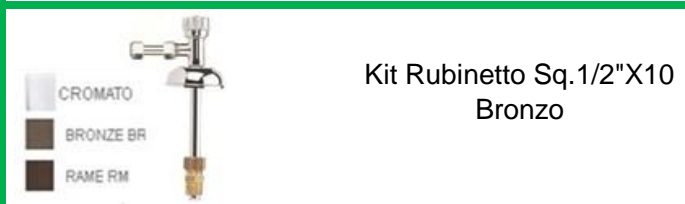

Codice	Riferimenti	U.M.	Busta	Box	Prezzo
KCRDC47	Bronzato	PZ	1	10	34,905 €



Codice	Riferimenti	U.M.	Busta	Box	Prezzo
CRL3\4	Dado Fisso	PZ	10	100	8,818 €
RGG	Dado Girevole	PZ	10	100	9,526 €





Curvetta 1/2"X10 Cromo Esag.

Codice	Cod. Off.	Pz	Off. Pubbico	Costo tot.	D.
C1\2X10E	C1\2X10E	1	€ 5,59	€ 5,59	1609
<b>Listino</b>	C1\2X10EX20	20	€ 5,30	€ 105,92	
5,88 €	C1\2X10EX50	50	€ 5,03	€ 251,55	
	C1\2X10EX100	100	€ 4,77	€ 476,62	



Rubinetto Squadra 1/2" F - 1/2" M C-Codulo 3/8" M

Codice	Cod. Off.	Pz	Off. Pubbico	Costo tot.	D.
RSCWCD	RSCWCD	1	€ 7,09	€ 7,09	100
<b>Listino</b>	RSCWCDX5	5	€ 6,71	€ 33,57	
7,46 €	RSCWCDX10	10	€ 6,38	€ 63,78	
	RSCWCDX15	15	€ 6,04	€ 90,63	



Rub. Filtro Snodo 1/2"X10

Codice	Cod. Off.	Pz	Off. Pubbico	Costo tot.	D.
RF1\2X10	RF1\2X10	1	€ 7,42	€ 7,42	2551
<b>Listino</b>	RF1\2X10X10	10	€ 7,03	€ 70,31	
7,81 €	RF1\2X10X20	20	€ 6,68	€ 133,59	
	RF1\2X10X50	50	€ 6,33	€ 316,39	



Rubinetto Filtro 1/2"X10 Vitone

Codice	Cod. Off.	Pz	Off. Pubbico	Costo tot.	D.
RF1\2X10V	RF1\2X10V	1	€ 6,71	€ 6,71	2806
<b>Listino</b>	RF1\2X10VX10	10	€ 6,36	€ 63,58	
7,06 €	RF1\2X10VX20	20	€ 6,04	€ 120,81	
	RF1\2X10VX50	50	€ 5,72	€ 286,13	

Riduzione 1/2Xm22X1 Ott Cromato



Codice	Prezzo	Rif.	Off. Pubbico
1350092094	3,65 €		3,19 €

Riduzione 3/4Fxm22X1 Ott Cromato "Xx"



Codice	Prezzo	Rif.	Off. Pubbico
1350092594	1,47 €		1,28 €

Riduzione M22X1 3/4 Ott Cromato



Codice	Prezzo	Rif.	Off. Pubbico
1350050894	7,22 €		6,32 €

Riduzione M22X1 X M24X1 Ottone Nichelato



Codice	Prezzo	Rif.	Off. Pubbico
1350050394	7,13 €		6,24 €

Riduzione 3\4Mxm24X1 Ott Cromato "Xx"



Codice	Prezzo	Rif.	Off. Pubbico
1350051094	2,07 €		1,81 €

Riduzione In Ottone Cromata 24/1Mx1/2\"M \"Xx\"



Codice	Prezzo	Rif.	Off. Pubbico
140/R1	1,39 €		1,21 €

Set Fissaggio Mix C. 40 2 Bul. "Xx"



Codice	Prezzo	Rif.	Off. Pubbico
HY-228A	1,94 €		1,70 €

Set Fissaggio Mix C. 40 1 Bul.



Codice	Prezzo	Rif.	Off. Pubbico
HY-228	1,67 €		1,46 €

Tappo Copriforo Pesante



Codice	Prezzo	Rif.	Off. Pubbico
TCP00	1,53 €	Cromo	1,34 €

Aeratore Prolungato 22X1F Bianco				Aeratore Prolungato 22X1F Cromo				Aeratore Prolungato 22X1F con 2 getti Cromo			
<b>Codice</b>	<b>Prezzo</b>	<b>Rif.</b>	<b>Off. Pubbico</b>	<b>Codice</b>	<b>Prezzo</b>	<b>Rif.</b>	<b>Off. Pubbico</b>	<b>Codice</b>	<b>Prezzo</b>	<b>Rif.</b>	<b>Off. Pubbico</b>
APFB	1,99 €		1,74 €	APFCR	3,97 €		3,48 €	APFRCR	5,60 €		4,90 €
Doccia A Mano Doccetta Portatile Per Lavandino Tubo Anticalcare Campeggio				ROmpigetto perLavello Risparmio acqua adattabile 22 femmina 24 maschio				ROmpigetto perLavello Risparmio acqua adattabile 22 femmina 24 maschio			
<b>Codice</b>	<b>Prezzo</b>	<b>Rif.</b>	<b>Off. Pubbico</b>	<b>Codice</b>	<b>Prezzo</b>	<b>Rif.</b>	<b>Off. Pubbico</b>	<b>Codice</b>	<b>Prezzo</b>	<b>Rif.</b>	<b>Off. Pubbico</b>
8827	15,12 €		13,23 €	69269	2,02 €		1,76 €	69265	1,89 €		1,65 €
ROmpigetto perLavello Risparmio acqua bloccabile nella canna erogazione				Rompigetto per lavello Risparmio Acqua				Guarnizione per Aeratore M24 pz 12			
<b>Codice</b>	<b>Prezzo</b>	<b>Rif.</b>	<b>Off. Pubbico</b>	<b>Codice</b>	<b>Prezzo</b>	<b>Rif.</b>	<b>Off. Pubbico</b>	<b>Codice</b>	<b>Prezzo</b>	<b>Rif.</b>	<b>Off. Pubbico</b>
69264	1,89 €		1,65 €	69274	3,78 €		3,31 €	69382	1,51 €		1,32 €
Rompigetto Rubinetto, Aeratore Rubinetto, Aeratori per Rubinetti, per la Sostituzione Della Testa del Rubinetto Della Cucina, 3 Impostazioni Attacco Femmina D, 22				Snodo Con Aeratore Per Bidet Vedi Anche Il Codice Aerocsf22				Aeratore Maschio Snodo Bidetz			
<b>Codice</b>	<b>Prezzo</b>	<b>Rif.</b>	<b>Off. Pubbico</b>	<b>Codice</b>	<b>Prezzo</b>	<b>Rif.</b>	<b>Off. Pubbico</b>	<b>Codice</b>	<b>Prezzo</b>	<b>Rif.</b>	<b>Off. Pubbico</b>
LM98734	16,38 €		14,33 €	ASBF	3,81 €		3,33 €	ASBM	2,82 €		2,47 €
Aeratore Af22 Ottone Cr F 22 Xx Vedi Anche Il Codice Af22 "Xx"				Aeratore Cromo M. 24X1				Aeratore Am28 Cromo M.28X1 Vedia Nche Il Codice Am28			
<b>Codice</b>	<b>Prezzo</b>	<b>Rif.</b>	<b>Off. Pubbico</b>	<b>Codice</b>	<b>Prezzo</b>	<b>Rif.</b>	<b>Off. Pubbico</b>	<b>Codice</b>	<b>Prezzo</b>	<b>Rif.</b>	<b>Off. Pubbico</b>
AEREXF22	0,38 €	22	0,33 €	AEREXM24	0,45 €	24	0,40 €	AEREXM28	0,69 €		0,61 €
				AEREXM22	0,30 €	22	0,26 €				

Sif.Inc.Lav B. Uscita 11/2"X40



Codice	Prezzo	Rif.	Off. Pubbico
SILPEHHD40	2,54 €	Bianca	2,23 €
SILPEHIHD40	2,42 €	Inox	2,12 €

Sif.Inc.Lav Phed Bianco+Uscita 40 Liscia



Codice	Prezzo	Rif.	Off. Pubbico
SILPEHB40	2,67 €	Bianca	2,34 €
SILPEHI40	2,67 €	Inox	2,34 €

Sifone Esterno X Lav Bianco



Codice	Prezzo	Rif.	Off. Pubbico
SELB	2,02 €		1,76 €
SELC	3,19 €		2,79 €

Racc.Diritto Tubo Sc.Lav 19X22



Codice	Prezzo	Rif.	Off. Pubbico
RDTSL1922	0,14 €		0,12 €
RDTSL1919	0,25 €		0,22 €

Canotto Con Cartella 1"1/2 X 40 Con Due Attacchi Lavatrice



Codice	Prezzo	Rif.	Off. Pubbico
1006AT2LAV	1,67 €	Bianca	1,46 €

Raccordo Doppio Per Due Lavatrici O Lavatrice/Asciugatrice Attacco 1"



Codice	Prezzo	Rif.	Off. Pubbico
1268POLL00	9,32 €		8,16 €

Attacco Lavatrice 11/4" X32 B.



Codice	Prezzo	Rif.	Off. Pubbico
AL11\4	1,83 €	11/4"	1,60 €
AL11\2	2,31 €	11/2"	2,02 €

Curvetta Scarico Lavatrice In Ottone Con Attacco



Codice	Prezzo	Rif.	Off. Pubbico
DCLCATA	13,11 €		11,47 €

Raccordo Doppio Per Due Lavatrici O Lavatrice/Asciugatrice Attacco Liscio Ø32



Codice	Prezzo	Rif.	Off. Pubbico
1268USCI32	8,82 €		7,72 €

Tubo Car. Lav.Con Curvacm.150 Ex Tc150C



Codice	Prezzo	Rif.	Off. Pubbico
TPCLC150	2,42 €	150	2,12 €
TPCLC200	3,02 €	200	2,65 €

Curva Abs X Lavatrice Bianco 1" Fx22 Vedi Articolo Rplbh

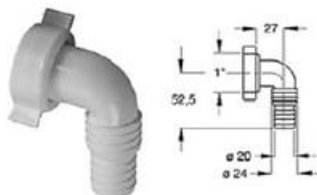

Codice	Prezzo	Rif.	Off. Pubbico
CSL1	1,09 €		0,95 €

Raccordo "Y" Sc. Lavatrice Pvc



Codice	Prezzo	Rif.	Off. Pubbico
RYSL	0,47 €		0,41 €

Tubo Carico Lavatrice Ff Senza Curva 150 Cm. Ex Tc150



Codice	Prezzo	Rif.	Off. Pubbico
TPCL150	2,47 €	150	2,16 €
TPCL200	2,77 €	200	2,43 €

Tubo Sca.Wash Fless Lav 60A200 Tsl200E



Codice	Prezzo	Rif.	Off. Pubbico
TESLL200	2,37 €	2 Mt	2,07 €
TESLL300	2,82 €	3 Mt	2,47 €

Racc.Dop.Nylon Lav 3/4X3/4X3/4



Codice	Prezzo	Rif.	Off. Pubbico
RCLDNFMM	1,46 €		1,28 €



Tubo Wc Bianco Con Rosone



Codice	Prezzo	Conf.	Off. Pubbico
TWC100X255	6,45 €	50	5,64 €

Morsetto Retto Wc Da 110Zz



Codice	Prezzo	Conf.	Off. Pubbico
MRWC	1,96 €	50	1,71 €

Morsetto Eccentrico Wc



Codice	Prezzo	Conf.	Off. Pubbico
MEWC	1,96 €	50	1,71 €

Morsetto Gomma B. Wc 50X30Zz



Codice	Prezzo	Conf.	Off. Pubbico
MWC50X30	0,29 €	50	0,25 €

Mors. Maggiorato X Wc M. 55X30



Codice	Prezzo	Conf.	Off. Pubbico
MWC55X30	0,54 €	50	0,48 €

Morsetto Gomma lianca per Wc D. 60X30



Codice	Prezzo	Conf.	Off. Pubbico
MWC60X30	0,45 €	50	0,39 €

Mors.X Scarico Conden. M.34X14



Codice	Prezzo	Conf.	Off. Pubbico
MSC34X14	0,842 €	50	0,737 €

Mors.Gomma B. X Sifoni M.76X40



Codice	Prezzo	Conf.	Off. Pubbico
MWC76X40	1,438 €	50	1,258 €

Mors. In Gomma X Vaso 60X40/44



Codice	Prezzo	Conf.	Off. Pubbico
MWC60X40/44	0,499 €	50	0,437 €

Morsetto Interno D. 32x 25/26



Codice	Prezzo	Conf.	Off. Pubbico
MI32X25/26	0,326 €	50	0,286 €

Morsetto In Gomma interno D. 40X26/32



Codice	Prezzo	Conf.	Off. Pubbico
MI40X26/32	0,325 €	50	0,284 €

Mors. Gomma Sotto Vaso 46X40



Codice	Prezzo	Conf.	Off. Pubbico
MI46X40	0,178 €	50	0,156 €

Mors.Gomma Sotto Vaso 50X26/32



Codice	Prezzo	Conf.	Off. Pubbico
MI50X26/32	0,336 €	50	0,294 €

Morsetto Int. 50X40



Codice	Prezzo	Rif.	Off. Pubbico
MI50X40	0,270 €		0,236 €

Morsetto In Gomma con bavetta Esterna



Codice	Prezzo	Rif.	Off. Pubbico
ME32X25/26	0,321 €	32	0,281 €
ME40X25/26	0,643 €	40	0,562 €



Guarnizione Esemte per idraulica

Codice	Riferimenti	U.M.	Busta	Box	Prezzo
2100ESE0C	D. 3/8"	PZ	10	100	0,016 €
2100ESE0D	D. 1/2"	PZ	10	100	0,020 €
2100ESE0G	D. 3/4"	PZ	10	100	0,024 €
2100ESE0H	D. 1"	PZ	10	100	0,032 €
2100ESEHB	D. 1 1/4"	PZ	10	100	0,055 €
2100ESEHD	D. 1 1/2"	PZ	10	100	0,066 €
2100ESEOL	D. 2"	PZ	10	100	0,382 €



Guarnizione in gomma Bordo Leggero Mm 2,3 D.1/2"

Codice	Riferimenti	U.M.	Busta	Box	Prezzo
GSP1/2	D. 1/2"	PZ	10	100	0,242 €
GSP3/4	D. 3/4"	PZ	10	100	0,345 €
GSP1	D. 1"	PZ	10	100	0,308 €
GSP11/4	D. 1 1/4"	PZ	10	100	0,399 €
GSP11/2	D. 1 1/2"	PZ	10	100	0,339 €



Benda Vinilica Bianca H.10 25M

Codice	Riferimenti	U.M.	Busta	Box	Prezzo
RBVB	Bianco	PZ	10	100	4,133 €
RBVGC	Grigio Chiaro	PZ	10	100	4,385 €
RBVBLU	Blu	PZ	10	100	4,385 €
RBVR	Rosso	PZ	10	100	4,385 €



Guarnizione Conica Bianca D.1/2"

Codice	Riferimenti	U.M.	Busta	Box	Prezzo
GCP1/2	D. 1/2"	PZ	10	100	0,160 €
GCP3/4	D. 3/4"	PZ	10	100	0,274 €
GCP1	D. 1"	PZ	10	100	0,355 €
GCP11/4	D. 1 1/4"	PZ	10	100	0,454 €
GCP11/2	D. 1 1/2"	PZ	10	100	0,364 €

Rotolo Loctite Mt.150 Rot.



Codice	Prezzo	Rif.	Off. Pubbico
L55	19,17 €		16,77 €

Tappo Provaimpian. Blu Da 1/2"



Codice	Prezzo	Rif.	Off. Pubbico
TPIBD	0,25 €	Blu	0,22 €
TPIRD	0,25 €	Rosso	0,22 €

Rotolo Nastro X Gas 12X12X0,10Zz



Codice	Prezzo	Rif.	Off. Pubbico
RTGAS01	0,30 €		0,27 €

Guarnizione per Radiaore 2 Mm. 1"



Codice	Prezzo	Rif.	Off. Pubbico
1094RAE20H	0,05 €	1"	0,04 €
1094RAE2HB	0,06 €	1 1/4"	0,06 €

Stearina In Pani Kg. 1



Codice	Prezzo	Rif.	Off. Pubbico
STCS01	4,48 €		3,92 €

Rotolo Nastro X Gas 19X15X0,20 Zx



Codice	Prezzo	Rif.	Off. Pubbico
RTGAS02	1,19 €		1,04 €

Canapa Pettinata Prezzo A Matassina Piccola Ogni 16 Matassine



Codice	Prezzo	Rif.	Off. Pubbico
CPM	0,79 €		0,69 €

Verga In Lega Stagno 33% Kg. 1



Codice	Prezzo	Rif.	Off. Pubbico
STST33	7,92 €		6,93 €

Pasta Verde Giun. Fil. Sicurverde 460 Gr Zz



Codice	Prezzo	Rif.	Off. Pubbico
PV	3,05 €		2,67 €



Cassetta Zaino Beta Plus  
CoD. 1030S

Scheda  
Tecnica



Codice	Cod. Off.	Pz	Prezzo	Costo tot.	D.
CZPB	CZPB	1	€ 34,21	€ 34,21	18
<b>Listino</b>	CZPBX5	5	€ 32,41	€ 162,03	
36,01 €	CZPBX10	10	€ 30,79	€ 307,86	
	CZPBX15	15	€ 27,15	€ 407,29	



Cassetta A Zaino Delta  
Elegant Silenziata Con  
Polisterolo Bianca CoD.  
1085

Scheda  
Tecnica



Codice	Cod. Off.	Pz	Prezzo	Costo tot.	D.
CZDB	CZDB	1	€ 34,90	€ 34,90	44
<b>Listino</b>	CZDBX5	5	€ 33,07	€ 165,34	
36,74 €	CZDBX10	10	€ 31,41	€ 314,14	
	CZDBX15	15	€ 27,71	€ 415,60	



Cassetta A Zaino Delta 2  
Pulsanti Silenziata Bianca  
CoD. 1083

Scheda  
Tecnica



Codice	Cod. Off.	Pz	Prezzo	Costo tot.	D.
CZ2DB	CZ2DB	1	€ 49,01	€ 49,01	313
<b>Listino</b>	CZ2DBX5	5	€ 46,43	€ 232,13	
51,59 €	CZ2DBX10	10	€ 44,11	€ 441,05	
	CZ2DBX15	15	€ 38,90	€ 583,51	



Cassetta Alta Completa  
Catinella senza tubo CoD.  
1041S

Scheda  
Tecnica



Codice	Cod. Off.	Pz	Prezzo	Costo tot.	D.
CAC	CAC	1	€ 30,46	€ 30,46	554
<b>Listino</b>	CACX5	5	€ 28,86	€ 144,30	
32,07 €	CACX10	10	€ 27,42	€ 274,17	
	CACX15	15	€ 24,18	€ 362,73	



Wc Galleggiante Magnetic  
Esterno-Incasso



Codice	Cod. Off.	Pz	Prezzo	Costo tot.	D.
CMAGNCER	CMAGNCER	5	€ 21,38	€ 106,90	9



Cassetta Plus Doppio  
Scar. B CoD. 1030S2

Scheda  
Tecnica



Codice	Cod. Off.	Mt	Prezzo	Costo tot.	D.
CZP2B	CZP2B	1	€ 48,03	€ 48,03	346
<b>Listino</b>	CZP2BX5	5	€ 45,50	€ 227,50	
50,56 €	CZP2BX10	10	€ 43,23	€ 432,26	
	CZP2BX15	15	€ 38,12	€ 571,87	



Cassetta Zaino Beta CR  
S/Rubinetto CoD. 1030

Scheda  
Tecnica



Codice	Cod. Off.	Mt	Prezzo	Costo tot.	D.
CZBB	CZBB	1	€ 34,52	€ 34,52	178
<b>Listino</b>	CZBBX5	5	€ 32,70	€ 163,52	
36,34 €	CZBBX10	10	€ 31,07	€ 310,69	
	CZBBX15	15	€ 27,40	€ 411,03	



Cassetta Cr Sfera 1  
Rivestita S/Rub

Scheda  
Tecnica



Codice	Cod. Off.	Mt	Prezzo	Costo tot.	D.
1000S1	1000S1	1	€ 47,47	€ 47,47	23
<b>Listino</b>	1000S1X5	5	€ 44,97	€ 224,86	
49,97 €	1000S1X10	10	€ 42,72	€ 427,23	
	1000S1X15	15	€ 37,68	€ 565,22	



Cassetta Wc A Zaino Con  
Tubo Water Saving  
Concept 1 Cr

Scheda  
Tecnica



Codice	Cod. Off.	Mt	Prezzo	Costo tot.	D.
1000C1	1000C1	1	€ 52,36	€ 52,36	17
<b>Listino</b>	1000C1X5	5	€ 49,60	€ 248,01	
55,11 €	1000C1X10	10	€ 47,12	€ 471,21	
	1000C1X15	15	€ 41,56	€ 623,40	



Galleggiante Blu Rambo  
3/8" CoD. 1520

Scheda  
Tecnica



Codice	Cod. Off.	Mt	Prezzo	Costo tot.	D.
GCZBR	GCZBR	1	€ 8,70	€ 8,70	402
<b>Listino</b>	GCZBRX5	5	€ 8,27	€ 41,34	
9,67 €	GCZBRX10	10	€ 7,83	€ 78,33	
	GCZBRX15	15	€ 7,74	€ 116,05	



Pull Bianca C/Catenella Cm. 70



Codice	Prezzo	Rif.	Off. Pubbico
PECB70	1,40 €		1,23 €

Tubo Cassetta A Zaino Plus B.Zx

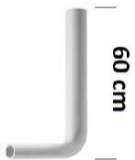

TUBO A ZAINO  
Ø50x32  
Tubi di scarico

Codice	Prezzo	Rif.	Off. Pubbico
TCZ60	7,33 €		6,42 €

Tubo Cassetta A Zaino D. 100X50



Codice	Prezzo	Rif.	Off. Pubbico
TCZ100	9,91 €		8,67 €

Guarnizione Meccanismo Cassetta Cr 1540



Scheda  
Tecnica



Codice	Prezzo	Rif.	Off. Pubbico
GMCZ	1,71 €		1,49 €

Meccanismo Cassetta Alta Alfa



Codice	Prezzo	Rif.	Off. Pubbico
1401A	12,12 €		10,60 €

Gruppo Sollevamento Pneu



Codice	Prezzo	Rif.	Off. Pubbico
GSC	19,52 €		17,08 €

Tubo Cassetta 2 Pei Usc. 45



Art. 1505

Scheda  
Tecnica



Codice	Prezzo	Rif.	Off. Pubbico
TCCA45	6,73 €		5,89 €

Tubo Cassetta Alta



Art. 1500A

TCAE

Scheda  
Tecnica



Art. 1500C

TCAI

Scheda  
Tecnica



Codice	Prezzo	Rif.	Off. Pubbico
TCAE	9,70 €	Est.	8,49 €
TCAI	9,70 €	Inc.	8,49 €

Pulsante Sollevamento Pneu Cr



Scheda  
Tecnica



Scheda  
Tecnica



Codice	Prezzo	Rif.	Off. Pubbico
PI	24,90 €		21,79 €

Pedale Sollevamento Pneu Cr



Scheda  
Tecnica



Codice	Prezzo	Rif.	Off. Pubbico
PPI	58,49 €		51,18 €

Pedale Sollevamento Pneu Cr.



Scheda  
Tecnica



Codice	Prezzo	Rif.	Off. Pubbico
PPE	72,69 €		63,60 €

Pulsante Sollevamento Pneu Cr



Scheda  
Tecnica



Scheda  
Tecnica



Codice	Prezzo	Rif.	Off. Pubbico
PE	34,07 €		29,81 €

Cassetta Incasso Fusion Per Muratura E Vaso A Pavimento



Codice	Prezzo	Rif.	Off. Pubbico
1060F	98,36 €		86,07 €

Placca Bianca A 2 Tasti X Cassetta Fusion Cr



Codice	Prezzo	Rif.	Off. Pubbico
1061B2	15,45 €		13,52 €

Placca Cromataa 2 Tasti X Cassetta Fusion Cr



Codice	Prezzo	Rif.	Off. Pubbico
1061C2	36,42 €		31,86 €

# Smart Ingresso **Cassette Pucci Eco**



**PUCCI® eco®**  
DUE PULSANTI DI SCARICO

Cod. P-CEICAL

Cassetta Eco Incasso New M  
Con Placca Linea Bianca P-0560

Codice	Cod. Off.	Pz	Prezzo	Costo tot.	D.
P-CEICAL	P-CEICAL	1	€ 163,35	€ 163,35	44
<b>Listino</b>	P-CEICALX3	3	€ 152,46	€ 457,39	
181,50 €	P-CEICALX6	6	€ 145,20	€ 871,21	
	P-CEICALX9	9	€ 134,31	€ 1.208,81	



**PUCCI® eco®**  
DUE PULSANTI DI SCARICO

Cod. P-CEICACL

Cassetta Eco Incasso New M  
Con Placca Linea Cromo P-0562

Codice	Cod. Off.	Mt	Prezzo	Costo tot.	D.
P-CEICACL	P-CEICACL	1	€ 188,10	€ 188,10	13
<b>Listino</b>	P-CEICACLX3	3	€ 175,56	€ 526,69	
209,00 €	P-CEICACLX6	6	€ 167,20	€ 1.003,21	
	P-CEICACLX9	9	€ 154,66	€ 1.391,96	



**PUCCI® eco®**  
DUE PULSANTI DI SCARICO

Cod. P-CEICA

Cassetta Eco Incasso New M  
Con Placca Ellisse Bianca P-0550

Codice	Cod. Off.	Pz	Prezzo	Costo tot.	D.
P-CEICA	P-CEICA	1	€ 163,35	€ 163,35	10
<b>Listino</b>	P-CEICAX3	3	€ 152,46	€ 457,39	
181,50 €	P-CEICAX6	6	€ 145,20	€ 871,21	
	P-CEICAX9	9	€ 134,31	€ 1.208,81	



**PUCCI® eco®**  
DUE PULSANTI DI SCARICO

Cod. P-CEICAC

Cassetta Eco Incasso New M  
Con Placca Ellisse Cromo P-0552

Codice	Cod. Off.	Mt	Prezzo	Costo tot.	D.
P-CEICAC	P-CEICAC	1	€ 188,10	€ 188,10	12
<b>Listino</b>	P-CEICACX3	3	€ 175,56	€ 526,69	
209,00 €	P-CEICACX6	6	€ 167,20	€ 1.003,21	
	P-CEICACX9	9	€ 154,66	€ 1.391,96	



**PUCCI® eco®**  
DUE PULSANTI DI SCARICO

**PROMO**

Cassetta Pucci Eco Incasso  
New M Senza Placca .

Codice	Cod. Off.	Pz	Prezzo	Costo tot.	D.
P-CEISP	P-CEISP	1	€ 149,65	€ 149,65	439
<b>Listino</b>	P-CEISPX3	3	€ 139,67	€ 419,02	
166,28 €	P-CEISPX6	6	€ 133,02	€ 798,14	
	P-CEISPX9	9	€ 123,05	€ 1.107,42	



Tubo Risc.35Cm.Conf.1

Codice	Cod. Off.	Mt	Prezzo	Costo tot.	D.
P-6560	P-6560	1	€ 20,14	€ 20,14	0
<b>Listino</b>	P-6560X5	5	€ 18,80	€ 93,98	
22,38 €	P-6560X10	10	€ 17,90	€ 179,00	
	P-6560X15	15	€ 16,56	€ 248,36	



**Placca Cromo Linea**

Placca Eco Linea  
280X180 Cr

**PROMO**

**PLACCHE 4,7 mm**

Codice	Cod. Off.	Pz	Prezzo	Costo tot.	D.
P-0562	P-0562	1	€ 58,07	€ 58,07	238
<b>Listino</b>	P-0562X3	3	€ 54,20	€ 162,60	
64,52 €	P-0562X6	6	€ 51,62	€ 309,71	
	P-0562X9	9	€ 47,75	€ 429,72	



**Placca Bianca Ellisse**

Placca Eco Ellisse  
280X180 B.

**PROMO**

**PLACCHE 4,7 mm**

Codice	Cod. Off.	Mt	Prezzo	Costo tot.	D.
P-0550	P-0550	1	€ 30,44	€ 30,44	628
<b>Listino</b>	P-0550X3	3	€ 28,41	€ 85,24	
33,83 €	P-0550X6	6	€ 27,06	€ 162,36	
	P-0550X9	9	€ 25,03	€ 225,28	



**Placca Cromo Ellisse**

Placca Eco Ellisse  
280X180 Cr

**PROMO**

**PLACCHE 4,7 mm**

Codice	Cod. Off.	Pz	Prezzo	Costo tot.	D.
P-0552	P-0552	1	€ 57,74	€ 57,74	6
<b>Listino</b>	P-0552X3	3	€ 53,89	€ 161,67	
64,15 €	P-0552X6	6	€ 51,32	€ 307,94	
	P-0552X9	9	€ 47,47	€ 427,27	



**Placca Bianca Linea**

Placca Eco Linea  
280X180 B.

**PROMO**

**PLACCHE 4,7 mm**

Codice	Cod. Off.	Mt	Prezzo	Costo tot.	D.
P-0560	P-0560	1	€ 30,45	€ 30,45	482
<b>Listino</b>	P-0560X3	3	€ 28,42	€ 85,26	
33,83 €	P-0560X6	6	€ 27,07	€ 162,40	
	P-0560X9	9	€ 25,04	€ 225,32	



**PUCCI® SARA 90**  
PULSANTE ALTO PER PARETI  
IN MURATURA - PER WC

Sara Inc. New Model Con  
Placca Linea Bianca P-0660

Codice	Cod. Off.	Pz	Prezzo	Costo tot.	D.
P-CSCA	P-CSCA	1	€ 121,71	€ 121,71	32
<b>Listino</b>	P-CSCAX3	3	€ 113,59	€ 340,78	
135,23 €	P-CSCAX6	6	€ 108,18	€ 649,10	
	P-CSCAX9	9	€ 100,07	€ 900,63	



**PUCCI® SARA 90**  
PULSANTE ALTO PER PARETI  
IN MURATURA - PER WC

Sara Inc. New Model  
S/Placca

Codice	Cod. Off.	Pz	Prezzo	Costo tot.	D.
P-CSSP	P-CSSP	1	€ 101,44	€ 101,44	38
<b>Listino</b>	P-CSSPX3	3	€ 94,67	€ 284,02	
112,71 €	P-CSSPX6	6	€ 90,17	€ 540,99	
	P-CSSPX9	9	€ 83,40	€ 750,63	



Cassetta Incasso Pucci  
Rame Senza Placca

Codice	Cod. Off.	Pz	Prezzo	Costo tot.	D.
P-CPSP	P-CPSP	1	€ 196,43	€ 196,43	0
<b>Listino</b>	P-CPSPX3	3	€ 186,09	€ 558,27	
206,77 €	P-CPSPX6	6	€ 176,78	€1.060,71	
	P-CPSPX9	9	€ 167,48	€1.507,32	



Cassetta Incasso Pucci  
Rame Completa Di Placca  
P-7510 Bianca

Codice	Cod. Off.	Pz	Prezzo	Costo tot.	D.
P-CPCA	P-CPCA	1	€ 217,39	€ 217,39	11
<b>Listino</b>	P-CPCAX3	3	€ 205,94	€ 617,83	
228,83 €	P-CPCAX6	6	€ 195,65	€1.173,88	
	P-CPCAX9	9	€ 185,35	€1.668,15	



Cassetta Incasso Pucci  
Rame Con Placca Cromo  
P-7512

Codice	Cod. Off.	Pz	Prezzo	Costo tot.	D.
P-CPCAC	P-CPCAC	1	€ 241,81	€ 241,81	10
<b>Listino</b>	P-CPCACX3	3	€ 229,08	€ 687,25	
254,54 €	P-CPCACX6	6	€ 217,63	€1.305,77	
	P-CPCACX9	9	€ 206,17	€1.855,57	



**PUCCI® SARA 90**  
PULSANTE ALTO PER PARETI  
IN MURATURA - PER WC

Sara Inc. New Model Con  
Placca Linea Cromo P-0662

Codice	Cod. Off.	Mt	Prezzo	Costo tot.	D.
P-CSCAC	P-CSCAC	1	€ 143,65	€ 143,65	11
<b>Listino</b>	P-CSCACX3	3	€ 134,07	€ 402,22	
159,61 €	P-CSCACX6	6	€ 127,69	€ 766,13	
	P-CSCACX9	9	€ 118,11	€1.063,01	



Placca Sara Linea Cromo

**PLACCHE 4,7 mm**

Codice	Cod. Off.	Mt	Prezzo	Costo tot.	D.
P-0662	P-0662	1	€ 46,54	€ 46,54	105
<b>Listino</b>	P-0662X3	3	€ 43,44	€ 130,31	
51,71 €	P-0662X6	6	€ 41,37	€ 248,21	
	P-0662X9	9	€ 38,27	€ 344,40	



**LINEA bianca**  
**80130660** Placca Sara Linea  
280X180 B.

**PLACCHE 4,7 mm**

Codice	Cod. Off.	Mt	Prezzo	Costo tot.	D.
P-0660	P-0660	1	€ 22,35	€ 22,35	110
<b>Listino</b>	P-0660X3	3	€ 20,86	€ 62,57	
24,83 €	P-0660X6	6	€ 19,86	€ 119,19	
	P-0660X9	9	€ 18,38	€ 165,38	



Placca C /Telaio Ros. Fil.  
Bot. E Prol. A 3 Cm.  
Bianca

Codice	Cod. Off.	Mt	Prezzo	Costo tot.	D.
P-7510	P-7510	1	€ 24,24	€ 24,24	45
<b>Listino</b>	P-7510X3	3	€ 22,97	€ 68,91	
25,52 €	P-7510X6	6	€ 21,82	€ 130,92	
	P-7510X9	9	€ 20,67	€ 186,05	



Placca Pucci C /Telaio  
Ros. Fil. Bot. E Prol. A 3  
Cm.Cromo 7512 Pz 1

Codice	Cod. Off.	Mt	Prezzo	Costo tot.	D.
P-7512	P-7512	1	€ 50,02	€ 50,02	4
<b>Listino</b>	P-7512X3	3	€ 47,38	€ 142,15	
52,65 €	P-7512X6	6	€ 45,01	€ 270,09	
	P-7512X9	9	€ 42,65	€ 383,81	



Cassetta Doppio Pulsante Senza Placche



Codice	Prezzo	Rif.	Off. Pubbico
P-CPDPSP	178,26 €	3	155,98 €

Placca C/Di Telaio, 2 Ros.Fil. Bott.E ProL. A 3 Cm.Cromo C.1

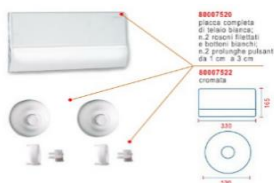

Codice	Prezzo	Rif.	Off. Pubbico
P-7522	44,69 €	3	39,10 €

Placca C / Di Telaio, 2 Ros. Fil. Bott. E ProL. A 3 Cm. B.

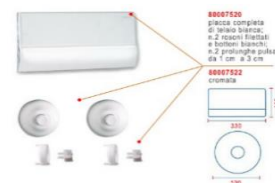

Codice	Prezzo	Rif.	Off. Pubbico
P-7520	21,56 €	3	18,86 €

Cassetta New Eco Esterna



Codice	Prezzo	Rif.	Off. Pubbico
P-CEE	88,58 €	3	77,50 €

Pucciplast Sara Tvs Modulo Cassetta Con Telaio Codice Prod: 1323000201



Codice	Prezzo	Rif.	Off. Pubbico
1323490201	226,75 €	3	198,41 €

Galleg.Completo Att.Laterale Conf.1



Codice	Prezzo	Rif.	Off. Pubbico
P-9151	28,89 €	5	25,28 €

Galleggiante Att.Centrale Fino 89 Conf.1



Codice	Prezzo	Rif.	Off. Pubbico
P-9250	27,62 €	5	24,16 €

Galleggiante Pucci Universale



Codice	Prezzo	Rif.	Off. Pubbico
P-9150	29,51 €	1	25,82 €
P-9150P	22,92 €	10	20,05 €

Galleggiante In Polistirolo



Codice	Prezzo	Rif.	Off. Pubbico
P-9078	3,58 €	5	3,13 €

Valvola Attacco Centrale Conf.1



Codice	Prezzo	Rif.	Off. Pubbico
P-9214	14,49 €	5	12,68 €

Conf. Guarnizione Scodellino Conf. 10 pz Prezzo Pz 1



Codice	Prezzo	Rif.	Off. Pubbico
P-9001	0,36 €	5	0,31 €

Dado Dx/Sx Guarn.3/8" Conf.1



Codice	Prezzo	Rif.	Off. Pubbico
P-9016	6,10 €	5	5,33 €

Pulsante Compl. Pvc 3 Cm.



Codice	Prezzo	Rif.	Off. Pubbico
P-7540	18,42 €	5	16,12 €

Pulsante Completo Cassetta 6/8 Conf.1



Codice	Prezzo	Rif.	Off. Pubbico
P-9035	19,72 €	5	17,25 €

Pulsante Pucci Univ. Ottone



Codice	Prezzo	Rif.	Off. Pubbico
P-9034	35,61 €	2	31,16 €
P-9034P	27,65 €	10	24,20 €

Serie Pulsante Conf.1



Codice	Prezzo	Rif.	Off. Pubbico
P-9030	6,68 €	46	5,85 €

Guarizione Gomma Sagomata 2,5 Mm  
Conf. Pz 5 Prezzo Pz. 1



Codice	Prezzo	Rif.	Off. Pubbico
P-9003	0,69 €	0	0,60 €

Ghiera Conf. 5 Prezzo Pz. 1



Codice	Prezzo	Rif.	Off. Pubbico
P-9024	1,35 €	313	1,18 €

Prolunga Pucci Cm. 1



Codice	Prezzo	Rif.	Off. Pubbico
P-9143	14,83 €	45	12,97 €

Prolunga Pulsante Cm.2 Conf.1



Codice	Prezzo	Rif.	Off. Pubbico
P-9044	15,55 €	56	13,61 €

Prolunga Pulsante Cm.3Conf.1

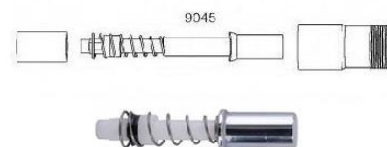

Codice	Prezzo	Rif.	Off. Pubbico
P-9045	16,30 €	31	14,26 €

Boccola Cromo Fissa Rosone Pz. 1



Codice	Prezzo	Rif.	Off. Pubbico
P-9032	1,66 €	149	1,45 €

Rosone Boccola Cromo Pucci



Codice	Prezzo	Rif.	Off. Pubbico
P-9033	8,31 €	104	7,27 €

Sieger Pulsante Pz. 1

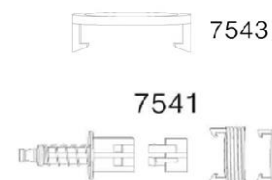

Codice	Prezzo	Rif.	Off. Pubbico
P-7543	1,37 €	97	1,20 €

Prolunga Pulsante Da 3Cm A5



**80007547**  
n.1 prolunga da 3 a 5 cm

Codice	Prezzo	Rif.	Off. Pubbico
P-7547	9,04 €	2	7,91 €

Rosone Filettato completo di bottone  
Conf.1



Codice	Prezzo	Rif.	Off. Pubbico
P-7532	21,84 €	Cromo	19,11 €
P-7530	7,70 €	Bianco	6,74 €

Serie Puls.Con Pist.Molla Guarn.A Labro  
Sieger E Prol.

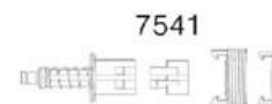

Codice	Prezzo	Rif.	Off. Pubbico
P-7541	9,31 €	50	8,15 €

Serie Guarnizione fondo piu'  
guarnizione scodellino galleggiante più



Codice	Prezzo	Rif.	Off. Pubbico
KGFTP	4,25 €	78	3,72 €

Guarnizione Sede Sfera Conf. 10 pz  
Prezzo sinsolo Pz. 1



Guarda Video  
Montaggio



Codice	Prezzo	Rif.	Off. Pubbico
P-9038	2,17 €	10	1,90 €
P-9038P	1,68 €	100	1,47 €

Sfera Di Tenuta Conf. 1



Codice	Prezzo	Rif.	Off. Pubbico
P-9039	8,12 €	34	7,11 €

Pistoncino Pz. 1



Codice	Prezzo	Rif. Off. Pubbico
P-9115	1,46 €	1,27 €

Pistoncino Con Guarnizione 10X5 Mm Pz. 1



Guarda Video Montaggio



Codice	Prezzo	Rif. Off. Pubbico
P-6555	1,44 €	1,26 €

Or161 Per Sede Estraibile Pz. 1

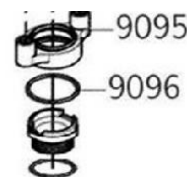

Codice	Prezzo	Rif. Off. Pubbico
P-9096	0,99 €	0,87 €

Leve Per Valvola Conf.5



Codice	Prezzo	Rif. Off. Pubbico
P-6556	4,36 €	3,82 €

Gruppo Sollevamento Con Sfera



Codice	Prezzo	Rif. Off. Pubbico
P-9970	38,75 €	33,90 €

Batteria Completa Con Sfera Conf.1



Codice	Prezzo	Rif. Off. Pubbico
P-5570	35,77 €	31,30 €

Estraibile Con 2Or 147 E Guar. Sede Econf.1



Codice	Prezzo	Rif. Off. Pubbico
P-6595	9,84 €	8,61 €

Gruppo Completo Sfera Con Astina Conf.1



Rame Polietilene  
6/8 Prod. fino all'83

Codice	Prezzo	Rif. Off. Pubbico
P-6261	11,97 €	10,47 €

Gruppo Rosone Ecc. Or 143 Can.22 Cm. Bianco Conf.1



Codice	Prezzo	Rif. Off. Pubbico
P-1390	4,27 €	3,74 €

Placca Eco Linea 280X180 Nero Lucido



Codice	Prezzo	Rif. Off. Pubbico
P-0561	28,42 €	24,87 €

Pucciplast 9560 Nuova Placca Eco (2 Pulsanti) Cm 33X18 Spessore 12 Mm Con



L'INNOVAZIONE CONTINUA



Codice	Prezzo	Rif. Off. Pubbico
P-9560	55,90 €	48,91 €

Placca Eco Linea Cromata 280X180Mm 4,7 Mm Spessore + Sportello Eco



NOVITA ASSOLUTA



Codice	Prezzo	Rif. Off. Pubbico
P-9562	75,71 €	66,25 €

Kit Tubo Risc.56X11 Riv. Completo Bianco Conf.1



80001460

n.1 - tubo di riscaldamento 56x11 cm con rivestimento e tappo regolabile in altezza (+2-2 cm), codulo in plastica, canotto 22 cm, rosone eccentrico e morsetto combinato Ø48-58 mm con coprimorsetto - bianco

Codice	Prezzo	Rif. Off. Pubbico
P-1460	26,08 €	22,82 €

Placca Sara Linea Bianca 280X180Mm 4,7 Mm Spessore + Sportello



L'INNOVAZIONE CONTINUA

Codice	Prezzo	Rif. Off. Pubbico
P-9660	48,86 €	42,75 €

Placca Sara Linea Cromata 280X180Mm 4,7 Mm Spessore + Sportello



L'INNOVAZIONE CONTINUA

Codice	Prezzo	Rif. Off. Pubbico
P-9662	68,12 €	59,61 €



Rubinetto Ottone Da 1/2" Conf.1



Codice	Prezzo	Rif.	Off. Pubbico
P-6544	18,37 €	3	16,08 €

Gruppo Valvola Compl. Conf.1



Codice	Prezzo	Rif.	Off. Pubbico
P-5250	28,78 €	3	25,18 €

Gruppo Valvola Completo Conf.1



Codice	Prezzo	Rif.	Off. Pubbico
P-6550	28,14 €	3	24,63 €

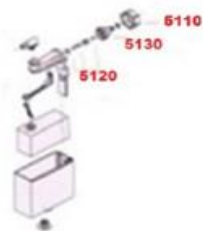

Pistoncino Con Guarn. Pz. 1

Codice	Prezzo	Rif.	Off. Pubbico
P-5120	1,43 €	3	1,25 €



Curva 31X19,5Cm. 50-40 Bianca

Codice	Prezzo	Rif.	Off. Pubbico
P-3320	13,85 €	3	12,12 €



Batteria Scarico Completa Viva

Codice	Prezzo	Rif.	Off. Pubbico
P-3110	20,86 €	3	18,25 €

Guarnizione Fondo In Para Pz.1



Codice	Prezzo	Rif.	Off. Pubbico
P-3130	1,36 €	10	1,19 €

Guarnizione Di Fondo Ø 54X26X3 Mm Fino Al '91 Abs Pz. 1



Codice	Prezzo	Rif.	Off. Pubbico
P-4230	0,86 €	10	0,76 €

Guarnizione Di Fondo Ø 63X31X3 Mm Nova - Abs Pz. 1



Codice	Prezzo	Rif.	Off. Pubbico
P-4231	0,86 €	10	0,76 €

Morsetto Comb.48-58 Bianco



Codice	Prezzo	Rif.	Off. Pubbico
P-1330	6,49 €	Bianco	5,68 €
P-1331	7,79 €	Cromo	6,82 €

Gruppo Sollevamento Batteria



Codice	Prezzo	Rif.	Off. Pubbico
P-4970	20,63 €	0	18,05 €

Telaio Guida Sfera Pz. 1

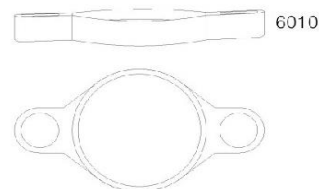

Codice	Prezzo	Rif.	Off. Pubbico
P-6010	1,20 €	81	1,05 €

Rubinetto Gallegian. Att.Basso Da 3/8" Con Sfera T /Ottone



Codice	Prezzo	Rif.	Off. Pubbico
RGAB3\8C	10,00 €	3/8"	8,75 €
RGAB1\2C	10,30 €	1/2"	9,01 €

Confezione Sportello Con Inserti M5 conf. 5 pz Prezzo Pz. 1



Codice	Prezzo	Rif.	Off. Pubbico
P-9076	4,45 €	Pz. 1	3,89 €
P-9049	3,86 €	Pz. 1	3,38 €

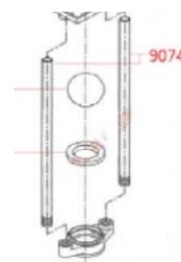

Tubo Silenziatore Per Tutti I Modelli

Codice	Prezzo	Rif.	Off. Pubbico
P-9074	2,57 €	109	2,25 €

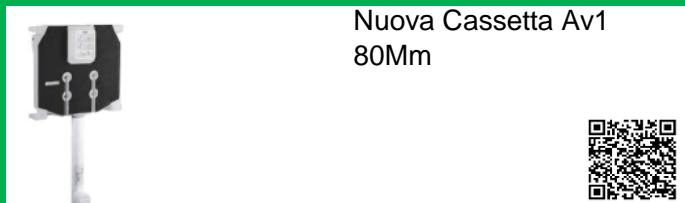

Nuova Cassetta Av1  
80Mm



Codice	Cod. Off.	Pz	Prezzo	Costo tot.	D.
38863000	38863000	1	€ 148,92	€ 148,92	337
<b>Listino</b>	38863000X3	3	€ 138,99	€ 416,98	
165,47 €	38863000X6	6	€ 132,38	€ 794,25	
	38863000X9	9	€ 122,45	€ 1.102,03	

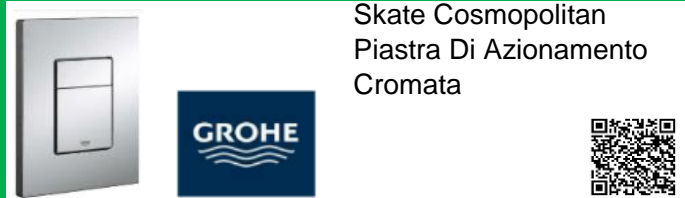

Skate Cosmopolitan  
Piastra Di Azionamento  
Cromata



Codice	Cod. Off.	Pz	Prezzo	Costo tot.	D.
38732000	38732000	1	€ 82,64	€ 82,64	63
<b>Listino</b>	38732000X3	3	€ 77,13	€ 231,39	
91,82 €	38732000X6	6	€ 73,46	€ 440,75	
	38732000X9	9	€ 67,95	€ 611,54	



Skate Cosmopolitan  
Piastra Di Azionamento  
Bianca



Codice	Cod. Off.	Pz	Off. Pubbico	Costo tot.	D.
38732SH0	38732SH0	1	€ 67,61	€ 67,61	198
<b>Listino</b>	38732SH0X3	3	€ 63,11	€ 189,32	
75,13 €	38732SH0X6	6	€ 60,10	€ 360,61	
	38732SH0X9	9	€ 55,59	€ 500,35	

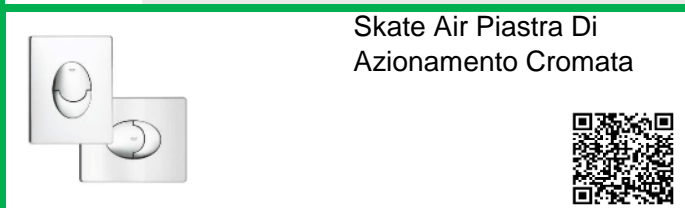

Skate Air Piastra Di  
Azionamento Cromata



Codice	Cod. Off.	Pz	Prezzo	Costo tot.	D.
38505000	38505000	1	€ 76,36	€ 76,36	0
<b>Listino</b>	38505000X3	3	€ 71,26	€ 213,79	
84,84 €	38505000X6	6	€ 67,87	€ 407,23	
	38505000X9	9	€ 62,78	€ 565,03	

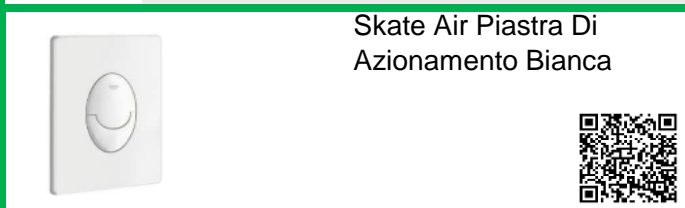

Skate Air Piastra Di  
Azionamento Bianca



Codice	Cod. Off.	Pz	Prezzo	Costo tot.	D.
38505SH0	38505SH0	1	€ 59,19	€ 59,19	288
<b>Listino</b>	38505SH0X3	3	€ 56,07	€ 168,22	
62,30 €	38505SH0X6	6	€ 53,27	€ 319,62	
	38505SH0X9	9	€ 50,47	€ 454,20	

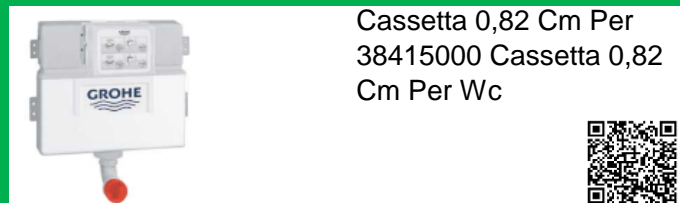

Cassetta 0,82 Cm Per  
38415000 Cassetta 0,82  
Cm Per Wc



Codice	Cod. Off.	Mt	Prezzo	Costo tot.	D.
38422000	38422000	1	€ 220,13	€ 220,13	65
<b>Listino</b>	38422000X3	3	€ 205,46	€ 616,38	
244,59 €	38422000X6	6	€ 195,67	€ 1.174,05	
	38422000X9	9	€ 181,00	€ 1.628,99	

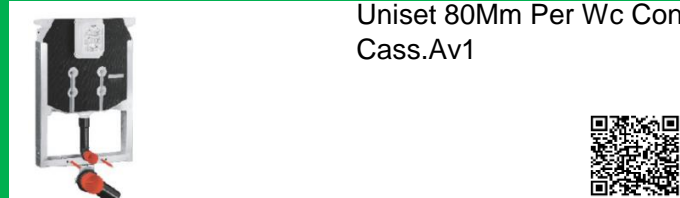

Uniset 80Mm Per Wc Con  
Cass.Av1



Codice	Cod. Off.	Mt	Prezzo	Costo tot.	D.
38729000	38729000	1	€ 251,66	€ 251,66	101
<b>Listino</b>	38729000X3	3	€ 234,88	€ 704,65	
279,62 €	38729000X6	6	€ 223,70	€ 1.342,18	
	38729000X9	9	€ 206,92	€ 1.862,28	

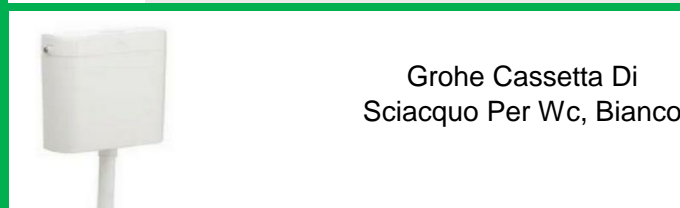

Grohe Cassetta Di  
Sciacquo Per Wc, Bianco

Codice	Cod. Off.	Mt	Off. Pubbico	Costo tot.	D.
38372SH0	38372SH0	1	€ 85,90	€ 85,90	0
<b>Listino</b>	38372SH0X3	3	€ 80,17	€ 240,52	
95,45 €	38372SH0X6	6	€ 76,36	€ 458,14	
	38372SH0X9	9	€ 70,63	€ 635,66	

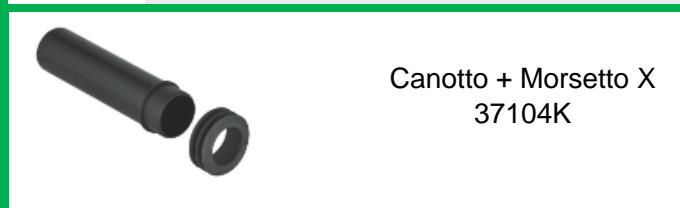

Canotto + Morsetto X  
37104K

Codice	Cod. Off.	Mt	Prezzo	Costo tot.	D.
42250000	42250000	1	€ 14,74	€ 14,74	1
<b>Listino</b>	42250000X5	3	€ 13,76	€ 41,28	
16,38 €	42250000X10	6	€ 13,10	€ 78,62	
	42250000X15	9	€ 12,12	€ 109,09	

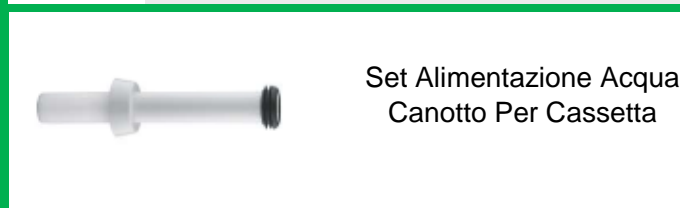

Set Alimentazione Acqua  
Canotto Per Cassetta

Codice	Cod. Off.	Mt	Prezzo	Costo tot.	D.
37103SH0	37103SH0	1	€ 16,64	€ 16,64	728
<b>Listino</b>	37103SH0X5	3	€ 15,76	€ 47,29	
17,51 €	37103SH0X10	6	€ 14,97	€ 89,85	
	37103SH0X15	9	€ 14,19	€ 127,68	

Skate Cosmopolitan Piastra Di  
Azionamento Acciaio Inox



**GROHE**

Codice	Prezzo	Rif.	Off. Pubbico
38732SD0	231,44 €	1	202,51 €
38732SD02	217,83 €	2	190,60 €

Skate Cosmopolitan Piastra Di  
Azionamento Nero Ultra Opaco



**GROHE**

Codice	Prezzo	Rif.	Off. Pubbico
38732KF0	225,83 €	1	197,60 €
38732KF02	212,55 €	2	185,98 €

Skate Cosmopolitan Piastra Di  
Azionamento Oro Lucido



**GROHE**

Codice	Prezzo	Rif.	Off. Pubbico
38732GL0	208,28 €	1	182,25 €
38732GL02	196,03 €	2	171,53 €

Skate Cosmopolitan Piastra Di  
Azionamento Oro Rosa Spazzolato



**GROHE**

Codice	Prezzo	Rif.	Off. Pubbico
38732DL0	208,28 €	1	182,25 €
38732DL02	196,03 €	2	171,53 €

Skate Cosmopolitan Piastra Di  
Azionamento Oro Spazzolato



**GROHE**

Codice	Prezzo	Rif.	Off. Pubbico
38732GN0	208,28 €	1	182,25 €
38732GN02	196,03 €	2	171,53 €

Valvola E Cestello Per 37594/38661



**GROHE**

Codice	Prezzo	Rif.	Off. Pubbico
42253000	64,90 €	1	56,79 €
422530002	61,08 €	2	53,45 €

Valvola Av1 Completa Valvola Av1  
Completa



**GROHE**

Codice	Prezzo	Rif.	Off. Pubbico
42320000	32,45 €	1	28,39 €
423200002	30,54 €	2	26,72 €

Valv. Scaric. Valv. Scaric



**GROHE**

Codice	Prezzo	Rif.	Off. Pubbico
43992000	51,38 €		44,96 €
439920002	48,36 €	2	42,31 €

Valv. Scaric. Valv. Scaric



**GROHE**

Codice	Prezzo	Rif.	Off. Pubbico
43486000	21,63 €		18,93 €
434860002	20,36 €	2	17,82 €

Valv. Carico Valv. Carico



**GROHE**

Codice	Prezzo	Rif.	Off. Pubbico
37092000	43,27 €	1	37,86 €
370920002	40,72 €	2	35,63 €

Set Alimentazione Acqua Canotto Per  
Cassetta



**GROHE**

Codice	Prezzo	Rif.	Off. Pubbico
37103SH0	16,64 €	1	14,56 €
37103SH02	15,76 €	2	13,79 €

Riduttore Di Flusso Per Casette



**GROHE**

Codice	Prezzo	Rif.	Off. Pubbico
42300000	19,81 €		17,34 €
423000002	18,65 €	2	16,32 €

Guarnizione Per Valvola Di Scarico Grohe  
42310000



**GROHE**

Codice	Prezzo	Rif.	Off. Pubbico
42310000	5,41 €	1	4,73 €
423100002	5,09 €	2	4,45 €

Cartuccia Ceramica 28Mm Cartuccia



**GROHE**

Codice	Prezzo	Rif.	Off. Pubbico
46580000	54,09 €	1	47,32 €
465800002	50,90 €	2	44,54 €

Canotto + Morsetto X 37104K



**GROHE**

Codice	Prezzo	Rif.	Off. Pubbico
42250000	14,74 €	1	12,90 €
422500002	13,76 €	2	12,04 €





Sifone Diba



Codice	Riferimenti	U.M.	Busta	Box	Prezzo
BAASP		PZ	1	10	51,862 €

Batteria Aria Con Kit



Colori Disponibili



Codice	Riferimenti	U.M.	Busta	Box	Prezzo
BAAC00	Cromo	PZ	1	10	107,084 €
BAAC47	Bronzo	PZ	1	10	185,246 €
BAAC65	Rame	PZ	1	10	188,316 €



Canna Curva 45° per cassetta Alta e tubo incassato

Codice	Riferimenti	U.M.	Busta	Box	Prezzo
305C30x24	30X240	PZ	1	10	4,788 €
305C30x28	30X280	PZ	1	10	5,443 €
305C30x32	30X320	PZ	1	10	6,199 €



Colori Disponibili



Codice	Riferimenti	U.M.	Busta	Box	Prezzo
300100	Cromo	PZ	10	100	20,278 €
300147	Bronzo	PZ	1	10	20,278 €
300165	Rame	PZ	1	10	20,278 €

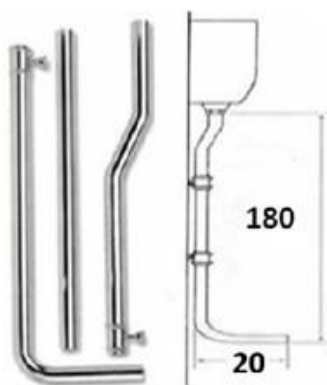

Fubo Esterno Cromo Diba

180

20

Colori Disponibili



Codice	Riferimenti	U.M.	Busta	Box	Prezzo
TED00	Cromo	PZ	10	100	204,980 €
TED47	Bronzo	PZ	1	10	219,618 €
TED65	Rame	PZ	1	10	223,820 €



Rosone Catis Dn. 80

Codice	Riferimenti	U.M.	Busta	Box	Prezzo
ROC00	Cromo	PZ	10	100	1,016 €
ROC47	Bronzo	PZ	1	10	0,917 €
ROC65	Rame	PZ	1	10	0,917 €



Canna 45°/Rosone Cm.28 CROMO

Codice	Riferimenti	U.M.	Busta	Box	Prezzo
CCR3000	Cromo	PZ	10	100	4,909 €
CCR3047	Bronzo	PZ	1	10	20,480 €



Batt.Univ.Comando Pneu. C/Guazz

Codice	Riferimenti	U.M.	Busta	Box	Prezzo
2410NT0000	6	PZ	10	100	16,392 €



Wc Valvola Pulsar Dual + Pulsante

Codice	Riferimenti	U.M.	Busta	Box	Prezzo
CPULSAR2	48	PZ	10	100	84,206 €



**CANALINA PRATIC**

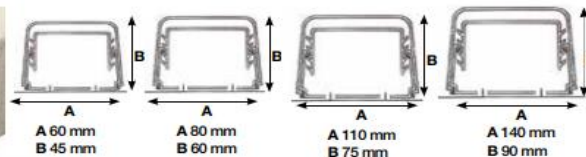
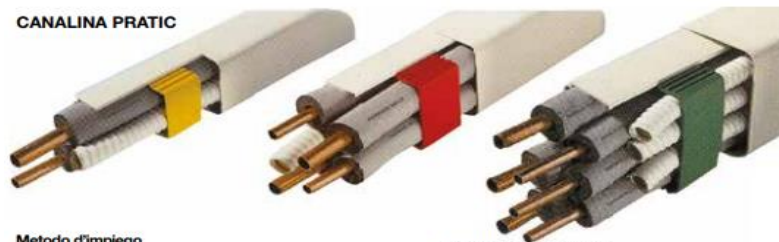

**Metodo d'impiego**

Fissare la base con i relativi tasselli ad espansione, con passo max 600 mm.

Completare l'impianto utilizzando gli accessori necessari ed inserire i tubi in rame ed i cavi fissandoli in corrispondenza dei tasselli con le staffe di bloccaggio.

Fissare il coperchio ad incastro.

N.B. Le staffe di bloccaggio sono rimovibili con una lieve divaricazione delle pareti

**Caratteristiche tecniche**

- materiale: PVC UL 94 V0 auto estinguente
- temperatura d'esercizio: -20°C / +60°C
- colore: bianco RAL 9001 verniciabile

Base Canale C/Coperchio



Codice	Riferimenti	Prezzo	Off. Pubbico	Conf.	Box
0612BC	60x45	3,32 €	2,90 €	2	96
0712BC	70x55	3,41 €	2,98 €	2	96
0812BC	80x60	4,97 €	4,35 €	2	96
0912BC	90x65	4,85 €	4,24 €	2	96
1212BC	120x75	5,87 €	5,14 €	2	96
1412BC	140x90	8,89 €	7,78 €	2	96

Curva Piana



Codice	Riferimenti	Prezzo	Off. Pubbico	Conf.	Box
0607CP	60x45	2,29 €	2,00 €	1	12
0707CP	70x55	2,14 €	1,88 €	1	12
0807CP	80x60	3,16 €	2,77 €	1	12
0907CP	90x65	2,94 €	2,57 €	1	12
1207CP	120x75	3,61 €	3,16 €	1	12
1407CP	140x90	5,05 €	4,42 €	1	12

Passaggio Muro



Codice	Riferimenti	Prezzo	Off. Pubbico	Conf.	Box
0610PM	60x45	2,18 €	1,91 €	1	12
0710PM	70x55	2,00 €	1,75 €	1	12
0810PM	80x60	2,77 €	2,43 €	1	12
0910PM	90x65	2,58 €	2,26 €	1	12
1210PM	120x75	3,20 €	2,80 €	1	12
	140x90				

Curva A Muro



Codice	Riferimenti	Prezzo	Off. Pubbico	Conf.	Box
0609CM	60x45	2,91 €	2,55 €	1	12
0709CM	70x55	2,70 €	2,36 €	1	12
0809CM	80x60	3,61 €	3,16 €	1	12
0909CM	90x65	3,35 €	2,93 €	1	12
1209CM	120x75	3,91 €	3,42 €	1	12
	140x90				

Tappo Terminale Type 06



Codice	Riferimenti	Prezzo	Off. Pubbico	Conf.	Box
0608IT	60x45	1,79 €	1,56 €	1	12
0708IT	70x55	1,73 €	1,52 €	1	12
0808IT	80x60	2,06 €	1,80 €	1	12

Angolo Esterno



Codice	Riferimenti	Prezzo	Off. Pubbico	Conf.	Box
0606AE	60x45	1,99 €	1,74 €	1	12
0706AE	70x55	1,88 €	1,64 €	1	12
0806AE	80x60	2,29 €	2,00 €	1	12

Cassetta  
Univerle.Prdisposizione  
Condizionatori



Codice	Riferimenti	Prezzo	Off. Pubbico	Conf.	Box
CPC	1108	5,51 €	4,82 €	12	144
CPC144		5,10 €	4,46 €	144	288

Angolo Interno



Codice	Riferimenti	Prezzo	Off. Pubbico	Conf.	Box
0605AI	60x45	1,99 €	1,74 €	1	12
0705AI	70x55	1,88 €	1,64 €	1	12
0805AI	80x60	2,29 €	2,00 €	1	12



Supporto Antivibrante D. 40  
X H.40 A Terra

Codice	Riferimenti	Prezzo	Off. Pubbico	Conf.	Box
107042	4 PZ	12,26 €	10,73 €	4	24



Supporto Antivibrante D. 30  
X H.20 A Terra

Codice	Riferimenti	Prezzo	Off. Pubbico	Conf.	Box
107040	4 PZ	5,45 €	4,77 €	4	24



Raccordo A Y Scarico  
Condensa

Codice	Riferimenti	Prezzo	Off. Pubbico	Conf.	Box
0021GY	Racc. "Y"	1,06 €	0,93 €	1	12



Sifone Condensa

Codice	Riferimenti	Prezzo	Off. Pubbico	Conf.	Box
0024SF	Sifone	2,31 €	2,02 €	1	12



Raccordo Retto Condensa

Codice	Riferimenti	Prezzo	Off. Pubbico	Conf.	Box
0023GL	Racc. Retto	0,74 €	0,64 €	1	12



Raccordo A "T" Condensa

Codice	Riferimenti	Prezzo	Off. Pubbico	Conf.	Box
0025GT	Racc. "T"	1,56 €	1,36 €	1	12



Raccordo Diritto Doppio 1/4"

Codice	Riferimenti	Prezzo	Off. Pubbico	Conf.	Box
81625AB05	D. 1/4"	1,06 €	0,92 €	1	12
81625AC05	D. 3/8"	1,49 €	1,30 €	1	12
81625AD05	D. 1/2"	2,36 €	2,07 €	1	12



Codice	Riferimenti	Prezzo	Off. Pubbico	Conf.	Box
81620AB05	D. 1/4"	0,86 €	0,75 €	1	12
81620AC05	D. 3/8"	1,28 €	1,12 €	1	12
81620AD05	D. 1/2"	1,50 €	1,31 €	1	12



Supporto A Pavimento A  
Cono

Codice	Riferimenti	Prezzo	Off. Pubbico	Conf.	Box
0501SC	28	3,17 €	2,77 €	1	12
0502PT	192	0,52 €	0,46 €	1	12



Supporto A Pavimento  
Mm.350 Pezzo Singolo

Codice	Riferimenti	Prezzo	Off. Pubbico	Conf.	Box
0350SP	Cm. 35	5,37 €	4,70 €	1	12
0450SP	Cm. 45	6,22 €	5,44 €	1	12
1000SP	Cm. 1000	9,34 €	8,17 €	1	12
0341TS	Coperchio	1,00 €	0,87 €	1	12



Kit Coppia Staffe Con  
Accessori E Barra  
SP 12/10

**PROMO**

Codice	Riferimenti	Prezzo	Off. Pubbico	Conf.	Box
BSC02	380X380X800	18,24 €	15,96 €	1	12
BSC04	410X380X800	19,43 €	17,00 €	1	12
BSC05	450X350X800	19,43 €	17,00 €	1	12
BSC03	480X380X800	19,43 €	17,00 €	1	12



Tubo Condensa

Codice	Riferimenti	Prezzo	Off. Pubbico	Conf.	Box
TC16	D. 16	1,00 €	0,87 €	30	300
TC20	D. 20	1,03 €	0,90 €	30	300





Kit valigetta con gruppo manometrico Ø 80 mm a due vie con tre tubi flessibili da 1500 mm e manometri  
2-way Kit, Ø 80 mm manifolds with 3 flexible hoses and pressure gauges, case included

Codice	Riferimenti	Prezzo	Off. Pubbico	Conf.	Box
05007050	0	158,34 €	138,55 €	1	4



BE100/5 - KG. 100 -  
RISOLUZIONE 5 GRAMMI  
CON VALIGIA

Codice	Riferimenti	Prezzo	Off. Pubbico	Conf.	Box
BE100/5	2	211,08 €	184,69 €	1	12



Flangiatubi universale in mm e poll.  
mm 3÷16 - inch 3/16÷5/8

Codice	Riferimenti	Prezzo	Off. Pubbico	Conf.	Box
CUE	176	30,89 €	27,03 €	1	12



Pompa Scarico Condensa  
600 Lt/H Zz Nth10.1

Codice	Cod. Off.	Pz	Prezzo	Costo tot.	D.
117310	117310	1	€ 96,51	€ 96,51	21
<b>Listino</b>	117310X2	2	€ 91,43	€ 182,86	
	117310X5	5	€ 86,86	€ 434,29	
	117310X10	10	€ 82,29	€ 822,86	



Climatizzatore Portatile  
Compatto Olimpia  
Splendid Che Deumidifica  
Dolceclima Compact 8 P  
2,64Kw A Gas R290

Codice	Riferimenti	Prezzo	Off. Pubbico	Conf.	D.
01921	5	580,45 €	507,90 €	1	5



Pinza amperometrica  
Pinza amperometrica di piccole dimensioni per letture DC/AC

Codice	Riferimenti	Prezzo	Off. Pubbico	Conf.	Box
DT-333	2	126,73 €	110,89 €	1	12



Cercafughe elettronico  
Cercafughe elettronico alogeno con sensore per refrigeranti avanzato ad "Effetto Corona" che assicura un'alta sensibilità e affidabilità. Rileva perdite di tutti i refrigeranti alogeni CFC, HFC, HCFC inclusi R410 e R32, vita del sensore pari a circa 50 ore, dotato di 2 batterie AA incluse.

Codice	Riferimenti	Prezzo	Off. Pubbico	Conf.	Box
29027007	Seeker	200,29 €	175,25 €	1	12



Kit Cartellatrice Universale  
Per Tubi In Pollici Da 3/16" A 5/8"  
Per Tubi In Millimetri Da 5 A 16  
Completa Di:  
- Tagliatubi Da 3 A 22 Mm

Codice	Riferimenti	Prezzo	Off. Pubbico	Conf.	Box
CT806AMLC	75	73,08 €	63,95 €	1	12

SERIE BM Doppio stadio  
BM Double stage series



Pompe per vuoto SERIE BM  
Doppio stadio Gas: R32 -R410  
Vacuoemtro integrato Attacchi 1/4" - 3/8"



Codice	Riferimenti	Prezzo	Off. Pubbico	Conf.	D.
PV2BM-71LM	DS2BM-71LM	310,94 €	272,07 €	1	4
PV4BM-127LM	DS4BM-127LM	390,10 €	341,33 €	1	2
PV8BM-241LM	DS8BM-241LM	588,72 €	515,13 €	1	2
PV10BM-297LM	DS10BM-297LM	685,84 €	600,11 €	1	2



Deumidificatore G3 Ferrari  
10 Lt 210W

Codice	Riferimenti	Prezzo	Off. Pubbico	Conf.	D.
G9000100	9	189,13 €	165,49 €	1	9

**Olimpia Splendid** A+  
 322  
 e.d.r.  
 Piattaforma By C.R.S.R.I.  
 App-store  
 Remote Control

**Clima Nexya S4 E Inverter 9000 R32**

Codice	Riferimenti	Prezzo	Off. Pubbico	Conf.	D.
NS409	9000 Btu	589,03 €	515,40 €	1	35
NS412	12000 Btu	643,94 €	563,44 €	1	38
NS418	18000 Btu	1.103,17 €	965,28 €	1	15
NS424	24000 Btu	1.343,57 €	1.175,62 €	1	14

**Olimpia Splendid** A+  
 Unità esterna per dual 18000 Btu  
**CEMYH18EI**

**Ue Nexya S4 E Dual Inverter 18**

Codice	Riferimenti	Prezzo	Off. Pubbico	Conf.	D.
CEMYH18EI	U.E. 18000	1.123,82 €	983,34 €	1	0
SENEH09	U.I. 9000	209,94 €	183,70 €	1	11
SENEH12	U.I. 12000	218,37 €	191,07 €	1	9

**SHERPA MONOBLOC**  
 Pompe di calore monoblocco  
 S2  
 COMPACT TECHNOLOGY  
 Compatibile con SIOS CONTROL

Codice	Riferimenti	Prezzo	Off. Pubbico	Conf.	D.
02303	S2 E 6	4.656,60 €	4.074,52 €	1	0
02304	S2 E 8	4.915,30 €	4.300,88 €	1	2
02305	S2 E 10	5.173,99 €	4.527,25 €	1	1
02306	S2 E 12	6.381,26 €	5.583,60 €	1	2
02307	S2 E 14	6.726,19 €	5.885,42 €	1	2
02308	S2 E 16	7.243,59 €	6.338,14 €	1	2
02309	S2 E 12 T	6.553,73 €	5.734,51 €	1	0
02310	S2 E 14 T	6.898,66 €	6.036,33 €	1	0
02311	S2 E 16 T	7.416,06 €	6.489,05 €	1	0

**Unità Esterna commerciale Monosplit**

Codice	Riferimenti	Prezzo	Off. Pubbico	Conf.	D.
OS-CANCH18EI	U.E. 18000	1.357,40 €	1.187,72 €	1	
OS-CANCH124EI	U.E. 24000	1.666,88 €	1.458,52 €	1	
OS-CANCH36EI	U.E. 36000	2.660,50 €	2.327,94 €	1	
OS-CANCHT36EI	U.E. 36000	2.676,79 €	2.342,19 €	1	
OS-CANCHT36EI	U.E. 48000	3.686,69 €	3.225,86 €	1	

**Olimpia Splendid**  
 Ventilconvettore SI Smart 200 B Includo Comando A Bordo B0855

Scopri tutte le Offerte Olimpia

Codice	Riferimenti	Prezzo	Off. Pubbico	Conf.	D.
02122	200 B	656,33 €	574,29 €	1	10
02123	400 B	713,82 €	624,59 €	1	20
02124	600 B	804,84 €	704,24 €	1	0
02125	800 B	938,98 €	821,61 €	1	0
02126	1000 B	991,68 €	867,72 €	1	0

**Olimpia Splendid**  
 Ventilconvettore Unico Smart 12 Hp

Codice	Riferimenti	Prezzo	Off. Pubbico	Conf.	D.
99283	1200 Kw 270	955,61 €	836,16 €	1	1
99281	1400 Kw 380	1.031,62 €	902,67 €	1	1

**Bi2 WALL**  
 Terminali high-wall

Codice	Riferimenti	Prezzo	Off. Pubbico	Conf.	D.
01784	400 V2V	918,64 €	803,81 €	1	0
01785	600 V2V	997,52 €	872,83 €	1	0
01786	800 V2V	1.076,39 €	941,84 €	1	0
01787	400 V3V	960,40 €	840,35 €	1	0
01788	600 V3V	1.034,64 €	905,31 €	1	0
01789	800 V4V	1.104,21 €	966,19 €	1	0
02457	1200 V3V	1.224,85 €	1.071,74 €	1	0
02461	1400 V3V	1.271,24 €	1.112,33 €	1	0

**Olimpia Splendid**  
 Sherpa Aquadue Tower S2  
 Sherpa Aquadue Tower S3

Codice	Riferimenti	Prezzo	Off. Pubbico	Conf.	D.
02004	U.E. S2	4.004,60 €	3.504,02 €	1	1
02044	U.I. TOWER S2	11.062,02 €	9.679,27 €	1	1



Idraclean Airsan Ag  
Flacone 0,75 Kg

Codice	Riferimenti	Prezzo	Off. Pubbico	Conf.	Box
I.AIRSB	43	12,83 €	11,22 €	1	1
I.AIRST5	78	39,87 €	34,88 €	1	1

Prodotto acido per pulitura Radiatori: Alluminio. 10%-30% secondo la consistenza del deposito calcareo. Fare Circolare e neutralizzare con Max N

MAX DA: Prodotto liquido specifico per Alluminio

Codice	Riferimenti	Prezzo
10105025	Kg. 10	25,86 €
10105030	Kg. 5	15,08 €



**AQUAAX**



Inibitore di corrosione  
Prodotto non acido per la protezione delle caldaie e impianti da fenomeni corrosivi ed incrostazioni

Dosaggio 1%  
volume

MAX LIFE 100 KG 1 "ZC"

Codice	Riferimenti	Prezzo
10106001	Kg. 1	€ 13,29



Risanante energico alcalino per la rimozione di ossidi e depositi per circuito di riscaldamento molto compromessi (max 1 settimana)

Dosaggio 1+10%  
sul volume in funziona dello sporco e del tempo utile per la pulizia

MAX LIFE 800 KG 1 "ZC"

Codice	Riferimenti	Prezzo
10106010	Kg. 1	€ 13,57



Decapante per nuovi impianti di riscaldamento il prodotto rimuove residui di saldatura, grassi, e residui oleosi, fanghi e contaminanti provenienti dall'installazione. Risanante non acido per impianti parzialmente compromessi

Dosaggio 1%  
volume

MAX LIFE 400 KG 1 "ZC"

Codice	Riferimenti	Prezzo
10106013	Kg. 1	€ 13,36



**Pompe disincrostanti con invertitore di flusso**

**Evolution 20 Turbo**



Codice	Capacità serbatoio (lt)	Dimensioni HxLxP (cm)	Pressione max (bar)	Portata max (lt/h)	Grado di protezione	Potenza HP	Peso (Kg)
10.100.025	20	55x44x32	2	5400	IP 54	0,75	10,5

Codice	Riferimenti	Prezzo
10100025	Evolution 20	€ 442,91





Dosatore Polifosfati Ghiera 1/2'''



Codice	Prezzo	Rif.	Off. Pubbico
DBSS	41,79 €	1	36,56 €
DBSS5	37,61 €	5	32,91 €

Dosamax Blu Stop Ghiera 1/2'''



Codice	Prezzo	Rif.	Off. Pubbico
DBSG	41,96 €	1	36,71 €
DBSG5	37,76 €	5	33,04 €

Kit Dosatore Polifosfati Per Immergas Victrix



**IMMERGAS**

Codice	Prezzo	Rif.	Off. Pubbico
3017323	86,27 €	1	75,49 €
30173235	77,64 €	5	67,94 €

Maxpoliquick Per Dosatori Proporzion. Ricariche 6 Pz



Codice	Prezzo	Rif.	Off. Pubbico
10160300	6,26 €	5	5,48 €
1016030010	5,64 €	10	4,93 €

Filtro Defangatore Magnetico



Codice	Prezzo	Rif.	Off. Pubbico
HSDPL	47,63 €	1	41,67 €
HSDPL5	42,87 €	5	37,51 €

Rosetta Riscal. Gambo Lungo Bianca "



Codice	Prezzo	Rif.	Off. Pubbico
RARU	0,17 €	24	0,15 €
RARU120	0,15 €	120	0,13 €

Neutralizzatore Acida Di Condensa Caldaie Attacco 3/4" - 3/4" M H. 220 X L. 47 Mm



Codice	Prezzo	Rif.	Off. Pubbico
NEUTRAWATER-B	23,25 €		20,34 €
NEUTRAWATER-B5	20,92 €	5	18,31 €

Kit Radiatore Bianco 1"X3/8"



Codice	Prezzo	Rif.	Off. Pubbico
SK1C	4,25 €	1	3,72 €
SK1C25	3,83 €	25	3,35 €



Kit Salvacaldaie: Composta Da Defangatore Magnetico, Filtro Neutralizzatore Di Condensa, Dosatore Polifosfati

Codice	Prezzo	Rif.	Off. Pubbico
10112045	124,00 €	1	108,50 €
101120455	111,60 €	5	97,65 €

Coppia Mensola Rad. All. Piat.



Codice	Prezzo	Rif.	Off. Pubbico
CMRA	1,97 €	10	1,73 €
CMRA25	1,78 €	25	1,55 €

Kit Termo 3/8"X 1/2" Tasca D. 16 Con Testina Termo



Codice	Prezzo	Rif.	Off. Pubbico
170T3010S	29,94 €		26,20 €
170T3010S25	26,77 €	25	23,42 €

Valvola + Detentore 3/8" Usc.1/2"



Codice	Prezzo	Rif.	Off. Pubbico
V+DEA	11,28 €		9,87 €
V+DEA5	10,08 €	5	8,82 €

Sportello Per Contatore Gas H. 600 Larg. 400 Prof. 20



Codice	Prezzo	Rif.	Off. Pubbico
SG6040Z	17,39 €	11	15,22 €

Sportello Per Contatore Acqua 300X400X20 Zincato



Codice	Prezzo	Rif.	Off. Pubbico
SA3040Z	16,27 €	119	14,24 €

Cassetta Gas Zin.500X400X250Zz



Codice	Prezzo	Rif.	Off. Pubbico
CGG04Z	31,88 €	24	27,89 €



Termo arredo  
Brand Sira  
o  
brand Lazzarini

Codice	Int.	Col.	Prezzo	Off. Pubbico	Conf.	Box
S45X80B	40	Bianc.	69,24 €	60,59 €	1	1
S45X110B	40	Bianc.	64,26 €	56,23 €	1	1
S45X120B	40	Bianc.	84,35 €	73,81 €	1	1
S45X140B	40	Bianc.	92,55 €	80,98 €	1	1
S50X80B	45	Bianc.	66,30 €	58,01 €	1	1
S50X120B	45	Bianc.	88,87 €	77,76 €	1	1
S50X140B	45	Bianc.	109,39 €	95,72 €	1	1
S45X80C	40	Cromo	124,20 €	108,67 €	1	1
S45X120C	40	Cromo	160,17 €	140,15 €	1	1
S45X140C	40	Cromo	170,72 €	149,38 €	1	1
S50X80C	45	Cromo	128,97 €	112,85 €	1	1
S50X120C	45	Cromo	164,04 €	143,53 €	1	1
S50X140C	45	Cromo	187,88 €	164,40 €	1	1



Scaldasalviette Elettrico  
Bolzano Ds2 Dr Bianco

E-BOLZANO - Manuale istruzioni.pdf  
 E-BOLZANO - scheda tecnica.pdf

Codice	l.	Col.	Prezzo	Off. Pubbico	Conf.	Box
S50X80BE	50	Bianc.	249,50 €	218,31 €	1	1
S50X120BE	50	Bianc.	268,65 €	235,06 €	1	1
S50X160BE	50	Bianc.	283,14 €	247,74 €	1	1
S50X180BE	50	Bianc.	303,85 €	265,87 €	1	1
S60X120BE	60	Bianc.	280,02 €	245,02 €	1	1
S60X160BE	60	Bianc.	299,19 €	261,80 €	1	1
S60X180BE	60	Bianc.	338,01 €	295,76 €	1	1



Rad Risc. All.  
Primavera H.600



Codice	Riferimenti	Prezzo	Off. Pubbico	Conf.	Box
P500	500	12,40 €	10,85 €	10	100
P600	600	19,88 €	17,40 €	10	100

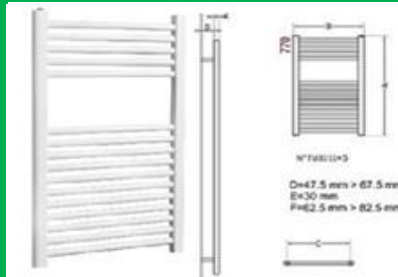

Termo Arredo Import  
40 int. Per 80 cm. H.  
colore Bianco

Codice	Riferimenti	Prezzo	Off. Pubbico	Conf.	Box	
S45X80OF	40	Bianc.	24,54 €	21,47 €	1	1

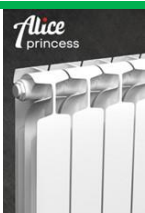

Rad Risc. All. Alice  
Princess H.600



Codice	Riferimenti	Prezzo	Off. Pubbico	Conf.	Box
AP50	500 580	20,28 €	17,74 €	10	100
AP60	600 680	21,93 €	19,19 €	10	100
AP70	700 780	23,50 €	20,56 €	10	100
AP80	800 880	25,38 €	22,21 €	10	100



Rad Risc. All. Alice Royal  
H.600



Codice	Riferimenti	Prezzo	Off. Pubbico	Conf.	Box
AR50	500 580	20,28 €	17,74 €	10	100
AR60	600 680	21,93 €	19,19 €	10	100
AR70	700 780	23,50 €	20,56 €	10	100
AR80	800 880	25,38 €	22,21 €	10	100



Rad Risc. All. Alice+  
H.1200



Codice	Riferimenti	Prezzo	Off. Pubbico	Conf.	Box
A+100	1000 1060	69,28 €	60,62 €	5	20
A+120	1200 1260	76,18 €	66,65 €	5	20
A+140	1400 1460	81,61 €	71,41 €	5	20
A+160	1600 1660	88,60 €	77,53 €	5	20
A+180	1800 1860	93,03 €	81,40 €	5	20
A+200	2000 2060	102,00 €	89,25 €	5	20



Rad Risc. All. Rubino  
H.1200

Codice	Riferimenti	Prezzo	Off. Pubbico	Conf.	Box
R100	1000 1060	62,31 €	54,52 €	5	20
R120	1200 1260	67,18 €	58,78 €	5	20
R140	1400 1460	72,03 €	63,02 €	5	20
R160	1600 1660	76,90 €	67,29 €	5	20
R180	1800 1860	81,65 €	71,45 €	5	20
R200	2000 2060	89,77 €	78,55 €	5	20

**Kit Scarico Fumo Caldaie Condensazione**

Codice	Riferimenti	Prezzo	Off. Pubbico	Conf.	Box
107692	Ariston	38,98 €	34,10 €	1	1
107697	Bosch	59,09 €	51,70 €	1	1

**Kit Scarico Fumo Tipo Vaillant Kit 8 Coass. C /Ter.Pbt 1,00**

Codice	Riferimenti	Prezzo	Off. Pubbico	Conf.	Box
KSFTV	Ariston	50,14 €	43,87 €	1	1
	Bosch				1

**Scaldabagno A Gas Camera Stagna Mini 12 Bf Erp Gpl**

**Scheda Tecnica**

Codice	Riferimenti	Prezzo	Off. Pubbico	Conf.	Box
8112631	12 Lt. Gpl	559,93 €	489,93 €	1	1
8112630	12 Lt. Met	559,93 €	489,93 €	1	1
8112632	16 Lt. Gpl	686,14 €	600,37 €	1	1
8112633	16 Lt. Met	686,14 €	600,37 €	1	1

**Termostufa Pellet Mod. Sofia 18 Kw Antracite**

SOFIA18AN 18 kw

**Termostufa Pellet Mod. Sofia 18 Kw Bordeaux**

**Termostufa Pellet Mod. Sofia 18**

Codice	Riferimenti	Prezzo	Off. Pubbico	Conf.	Box
SOFIA18AN	18 kw	3.265,92 €	2.857,68 €	1	1
SOFIA18BO	18 kw	3.265,92 €	2.857,68 €	1	1

**Scaldabagno Bandini Braun Volano Termico Sep 5 anni di garanzia**

**Scheda Tecnica**

Codice	Riferimenti	Prezzo	Off. Pubbico	Conf.	Box
SV50C5VSEP	50 Lt.	395,02 €	345,64 €	1	1
SV80C5VSEP	80 Lt.	418,26 €	365,97 €	1	1
SV100C5VSEP	100 Lt.	460,08 €	402,57 €	1	1

**Junkers Scaldabagno Therm 4204 Nox Lt 10 Metano**

Codice	Riferimenti	Prezzo	Off. Pubbico	Conf.	Box
7736504907	Metano	338,63 €	296,30 €	1	1
7736504909	Gpl	338,63 €	296,30 €	1	1

## PANNELLI GRUPPO TP

**PANNELLI GRUPPO TP COMPOSTO DA:**

- 1) Art. 8500073 SIME PLANO 272
- 2) Collettore solare piano struttura in allum. navale arricchito al magnesio Pz. 2
- 3) 8500301 KIT Connessione dei due Collettore solare SIMESOL 1
- 4) 8500005 Telaio di fissaggio
- 5) 8106952 "KIT GI 1CP composto da:
  - A) GR. IDR. SOLARE 1C TERMOSOLIS
  - B) KIT STAFFA SUPP. VASO ESP. SOL.
  - C) ASS. TUBO CORRUG. COLL. VASO ESP."

Codice	Riferimenti	Prezzo	Off. Pubbico	Conf.	Box
8500073TP	Tetto Piano	2.844,69 €	2.489,10 €	1	12
8500073TF	Tetto Inclinato	2.887,56 €	2.526,62 €	1	12

## Pannello Solare Naturale Collettore Solare Lt. 300

**Scheda Tecnica**

Codice	Riferimenti	Prezzo	Off. Pubbico	Conf.	Box
8500269	Piano/Incl.	2.929,18 €	2.563,04 €	1	12

## Scaldabacqua a Pompa

**Scheda Tecnica**

Installabile a muro nella versione 110 litri e a basamento nelle versioni 200 e 300 litri. Serbatoio in acciaio con vetrificazione a doppio strato. Anodo di magnesio anticorrosione sostituibile. Serpentino di riscaldamento avvolto esternamente al bollitore. Funzione anti-legionella automatica. Elevata silenziosità. Serpentino interno per collegamento ad impianto solare termico (versione 300 S). Contatto per integrazione con impianto fotovoltaico. Resistenza elettrica integrata per assicurare comfort anche nelle condizioni più estreme. Il prodotto raggiunge i requisiti necessari ai fini della detrazione fiscale del 65% e 110%

Codice	Riferimenti	Prezzo	Off. Pubbico	Conf.	Box
8115842	Lt 110	1.775,39 €	1.553,47 €	1	12
8115843	Lt 200	2.539,79 €	2.222,32 €	1	12
8115845	Lt 300 S	3.032,96 €	2.653,84 €	1	12

Codice	Eco contributo GSE	Importo
8500269	Eco contributo GSE	2.055,00 €
8115842	Eco contributo GSE	400,00 €
8115843	Eco contributo GSE	400,00 €
8115845	Eco contributo GSE	700,00 €





Tubo Lineare in Acciaio Monoparete

Codice	D.	Cm.	D.tà	Prezzo
MLA25080	80	0,25	4	8,67 €
MLA500080	80	0,50	4	11,21 €
MLA100080	80	1,00	5	23,46 €
MLA250100	100	0,25	5	9,68 €
MLA500100	100	0,50	33	16,33 €
MLA100100	100	1,00	12	26,16 €
MLA250120	120	0,25	0	10,56 €
MLA500120	120	0,50	2	19,13 €
MLA100120	120	1,00	8	25,33 €
MLA250150	150	0,25	4	12,39 €
MLA500150	150	0,50	3	23,66 €
MLA100150	150	1,00	4	36,67 €
MLA250180	180	0,25	5	15,22 €
MLA500180	180	0,50	5	27,90 €
MLA100180	180	1,00	5	43,67 €
MLA250200	200	0,25	5	16,00 €
MLA500200	200	0,50	5	28,90 €
MLA100200	200	1,00	4	46,34 €



Fascetta di Bloccaggio

Codice	D.	Off.	D.tà	Prezzo
FB080	80	5	25	3,55 €
FB100	100	5	110	3,88 €
FB120	120	5	16	4,11 €
FB150	150	5	11	4,56 €
FB180	180	5	20	4,99 €
FB200	200	5	12	5,44 €



Guarnizione Interna

Codice	D.	Off.	D.tà	Prezzo
GS0800	80	5	0	2,22 €
GS0100	100	5	129	2,77 €
GS0120	120	5	50	3,33 €
GS0150	150	5	12	4,44 €
GS0180	180	5	20	4,99 €
GS0200	200	5	4	5,57 €



Collare di fissaggio con tassello

Codice	Off.	D.tà	Prezzo	
CCTE080	80	5	67	9,45 €
CCTE100	100	5	50	11,11 €
CCTE120	120	5	50	11,67 €
CCTE150	150	5	10	13,33 €
CCTE180	180	5	10	14,44 €
CCTE200	200	5	0	15,55 €



Staffa a muro

Codice	Off.	D.tà	Prezzo	
SM080	80	5	10	35,56 €
SM100	100	5	20	36,11 €
SM120	120	5	10	16,13 €
SM150	150	5	10	20,16 €
SM180	180	5	10	23,69 €
SM200	200	5	6	55,57 €



Curva a 45°

Codice	D.	Off.	D.tà	Prezzo
C45080	80	2	37	19,68 €
C45100	100	2	19	20,99 €
C45120	120	2	9	17,69 €
C45150	150	2	2	19,90 €
C45180	180	2	5	21,54 €
C45200	200	2	0	30,57 €



Curva a 90°

Codice	D.	Off.	D.tà	Prezzo
C90080	80	2	31	26,11 €
C90100	100	2	28	27,12 €
C90120	120	2	8	29,02 €
C90150	150	2	10	25,75 €
C90180	180	2	5	43,97 €
C90200	200	2	5	54,35 €



Braga a T 90°

Codice	D.	Off.	D.tà	Prezzo
RT90080	80	1	3	40,28 €
RT90100	100	1	9	42,08 €
RT90120	120	1	10	34,66 €
RT90150	150	1	5	39,23 €
RT90180	180	1	5	65,51 €
RT90200	200	1	3	72,97 €



Tappo Con Scarico E/O Cieco Inox D. 80

Codice	D.	Off.	D.tà	Prezzo
TCS080	80	1	5	29,79 €
TCS100	100	1	33	31,68 €
TCS130	120	1	5	33,57 €
TCS150	150	1	5	38,13 €
TCS180	180	1	5	41,00 €
TCS200	200	1	3	32,32 €



Supporto Per Solaio E/O Muro D. 200

Codice	D.	Off.	D.tà	Prezzo
SPS080	80	1	10	35,69 €
SPS100	100	1	10	66,95 €
SPS120	120	1	10	75,32 €
SPS150	150	1	2	47,39 €
SPS180	180	1	2	100,42 €
SPS200	200	1	2	100,95 €



Braga a V 45°

Codice	D.	Off.	D.tà	Prezzo
RT135080	80	1	5	71,07 €
RT135100	100	1	5	71,07 €
RT135120	120	1	5	60,13 €
RT135150	150	1	4	74,35 €
RT135180	180	1	5	102,88 €
RT135200	200	1	0	107,56 €



Terminale a 4 venti innesto maschio

Codice	D.	Off.	D.tà	Prezzo
CB100	100	1	4	80,56 €
CB120	120	1	2	85,14 €
CB150	150	1	2	50,17 €
CB180	180	1	2	107,56 €
CB200	200	1	1	110,47 €



Terminale EOLICO innesto maschio

Codice	D.	Off.	D.tà	Prezzo
CR100	100	1	0	122,97 €
CR125	120	1	0	122,97 €
CR150	150	1	0	126,43 €
CR180	180	1	2	143,39 €
CR200	200	1	0	151,53 €



Cappello Parapioggia

Codice	D.	Off.	D.tà	Prezzo
CPP080	80	1	3	19,53 €
CPP100	100	1	9	21,66 €
CPP120	120	1	5	20,17 €
CPP150	150	1	2	23,58 €
CPP200	200	1	1	29,94 €

Copricaldaia - Copriscaidino



### Copricaldaia Verniciato Bianco

Codice	H	L	P	Prezzo
P160P	800	480	300	49,21 €
P167P BC85	850	500	350	61,03 €
P170P	870	500	350	75,35 €
BC102S BC102S	920	500	350	81,14 €
P200P BC102	1020	550	450	81,14 €
P213P BC108	1060	600	450	81,14 €
P236P BC125	1200	600	450	101,32 €



Tubo Alluminio Estensibile



### Esalatore Fumi Colore Bianco

Codice	Riferimenti	Prezzo	Off. Pubbico	Conf.	Box
E110	D. 110	19,93 €	17,44 €	1	12
E120	D. 120	19,93 €	17,44 €	1	12
E130	D. 130	19,93 €	17,44 €	1	12
E140	D. 140	19,93 €	17,44 €	1	12

Codice	Riferimenti	Prezzo	Off. Pubbico	Conf.	Box
TA80	mm 80	10,95 €	9,59 €	1	12
TA100	mm 100	12,89 €	11,28 €	1	12
TA120	mm 120	15,58 €	13,63 €	1	12
TA130	mm 130	16,54 €	14,47 €	1	12
TA140	mm 140	18,47 €	16,16 €	1	12
TA150	mm 150	19,47 €	17,04 €	1	12
TA160	mm 160	20,70 €	18,11 €	1	12
TA180	mm 180	23,71 €	20,74 €	1	12
TA200	mm 200	25,90 €	22,67 €	1	12
TA300	mm 300	44,66 €	39,08 €	1	12

### Ricambi Scaldabagni

Valvola Scald. Pes. Leva 1/2"Mf



Codice	Prezzo	Rif.	Off. Pubbico
VSSL1\2	3,04 €	7063	2,66 €

Valvola Scald. Pesante 1/2"Mf



Codice	Prezzo	Rif.	Off. Pubbico
VSS1\2	2,53 €	4000	2,21 €

Valvola Multifunzione 3/4" Mf



Codice	Prezzo	Rif.	Off. Pubbico
V1403\4	13,66 €	75	11,96 €

Resistenza Scald F.11/4" 1200W



Codice	Prezzo	Rif.	Off. Pubbico
RDT12	9,74 €	142	8,52 €

Resistenza Scaldabagno 1200W



Codice	Prezzo	Rif.	Off. Pubbico
RDF12	9,36 €	404	8,19 €

Valvola Scald. Con Rid. Pres.



Codice	Prezzo	Rif.	Off. Pubbico
VSRP	8,42 €	851	7,36 €

Termostato Scaldabagno Univer.



Codice	Prezzo	Rif.	Off. Pubbico
TUS	4,81 €	377	4,21 €

Resistenza Scaldabagno Faston Prolungati 1200W



Codice	Prezzo	Rif.	Off. Pubbico
RDAP12	9,36 €	339	8,19 €

Guarnizione flangia 75 Integrale



Codice	Prezzo	Rif.	Off. Pubbico
GCI75	1,21 €	282	1,06 €
GRT	0,17 €		0,15 €



Scaldabagno Bandini  
Braun Vetroporcellnatao  
Vert. 12 Lt Sopralavello 2  
Anni Garanzia



Codice	Cod. Off.	Pz	Prezzo	Costo tot.	D.
A12SP2A	A12SP2A	1	€ 120,66	€ 120,66	37
<b>Listino</b>	A12SP2AX5	5	€ 114,91	€ 574,56	
143,64 €	A12SP2AX10	10	€ 106,29	€1.062,94	
	A12SP2AX15	15	€ 96,53	€1.447,89	



Scaldabagno Bandini  
Braun Vetroporcellnatao  
Vert. 12 Lt Sottolavello 2  
Anni Garanzia



Codice	Cod. Off.	Pz	Prezzo	Costo tot.	D.
A12ST2A	A12ST2A	1	€ 113,12	€ 113,12	59
<b>Listino</b>	A12ST2AX5	5	€ 107,73	€ 538,65	
134,66 €	A12ST2AX10	10	€ 99,65	€ 996,50	
	A12ST2AX15	15	€ 90,49	€1.357,40	



Scaldabagno Bandini  
Braun Vetroporcellnatao  
Vert. 30 Lt 2 Anni  
Garanzia

Codice	Cod. Off.	Pz	Prezzo	Costo tot.	D.
SE302A	SE302A	1	€ 170,93	€ 170,93	11
<b>Listino</b>	SE302AX5	5	€ 162,79	€ 813,96	
203,49 €	SE302AX10	10	€ 150,58	€1.505,83	
	SE302AX15	15	€ 136,75	€2.051,18	



Scaldabagno Bandini  
Braun Vetroporcellnatao  
Vert. 50 Lt 2 Anni  
Garanzia

Codice	Cod. Off.	Pz	Prezzo	Costo tot.	D.
SE502A	SE502A	1	€ 173,45	€ 173,45	59
<b>Listino</b>	SE502AX5	5	€ 165,19	€ 825,93	
206,48 €	SE502AX10	10	€ 152,80	€1.527,97	
	SE502AX15	15	€ 138,76	€2.081,34	



Scaldabagno Bandini  
Braun Vetroporcellnatao  
Vert. 80 Lt 2 Anni  
Garanzia



Codice	Cod. Off.	Pz	Prezzo	Costo tot.	D.
SE802A	SE802A	1	€ 201,10	€ 201,10	68
<b>Listino</b>	SE802AX5	5	€ 191,52	€ 957,60	
239,40 €	SE802AX10	10	€ 177,16	€1.771,56	
	SE802AX15	15	€ 160,88	€2.413,15	

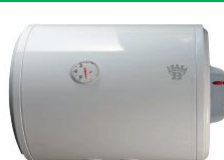

Scaldabagno Bandini  
Braun Vetroporcellnatao  
Oriz. 80 Lt 2 Anni  
Garanzia Sx



Codice	Cod. Off.	Pz	Prezzo	Costo tot.	D.
SO802ASX	SO802ASX	1	€ 241,32	€ 241,32	0
<b>Listino</b>	SO802ASXX5	5	€ 229,82	€1.149,12	
287,28 €	SO802ASXX10	10	€ 212,59	€2.125,87	
	SO802ASXX15	15	€ 193,05	€2.895,78	

### Scaldabagno Flangiato, Anodo, Regolazione



**smavit**  
Scheda Tecnica

Codice	Riferimenti	LT	Gar.	Prezzo	Off. Pubbico
SVV30	Scaldabagno Verticale 30 LT	30	2 A	122,36 €	107,07 €
SVV50	Scaldabagno Verticale 50 LT	50	2 A	141,82 €	124,09 €
SVV80	Scaldabagno Verticale 80 LT	80	2 A	151,43 €	132,50 €
SVH50	Scaldabagno Orizzontale 50 LT	50	2 A	187,57 €	164,12 €
SVH80	Scaldabagno Orizzontale 80 LT	80	2 A	163,45 €	143,02 €



**smavit**  
Scheda Tecnica

### Scaldabagno Flangiato, Anodo, Regolazione



Codice	Riferimenti	LT	Gar.	Prezzo	Off. Pubbico
SVK10	Scaldabagno 10 Lt Sopralavello	10	2 A	96,48 €	84,42 €
SVK10U	Scaldabagno 10 Lt Sottolavello	10	2 A	98,83 €	86,48 €
SVK15	Scaldabagno 15 Lt Sopralavello	15	2 A	105,89 €	92,65 €
SVK15U	Scaldabagno 15 Lt Sottolavello	15	2 A	108,24 €	94,71 €
SVK30	Scaldabagno 30 Lt Sopralavello	30	2 A	127,07 €	111,18 €



Cod. 201-302-404







Codice	Prezzo	Rif.	Off. Pubbico
DISOVE	4,25 €	6	3,72 €

Codice	Prezzo	Rif.	Off. Pubbico
93060001	42,68 €	6	37,35 €

Codice	Prezzo	Rif.	Off. Pubbico
4073A	8,93 €	6	7,81 €



Codice	Prezzo	Rif.	Off. Pubbico
PSE	2,48 €	6	2,17 €
PSEX12	2,35 €	12	2,06 €

Codice	Prezzo	Rif.	Off. Pubbico
PSP	6,61 €	6	5,78 €
PSPX12	6,28 €	12	5,49 €

Codice	Prezzo	Rif.	Off. Pubbico
RFG	8,61 €		7,53 €



Codice	Prezzo	Rif.	Off. Pubbico
PUK	3,41 €	12	2,98 €
PUKX144	3,24 €	144	2,83 €

Codice	Prezzo	Rif.	Off. Pubbico
MINIARCO1	7,41 €		6,48 €
MINIARCO1X6	7,04 €	6	6,16 €

Codice	Prezzo	Rif.	Off. Pubbico
KITCC32	12,21 €	1	10,69 €
KITCC32X4	11,60 €	4	10,15 €



Codice	Prezzo	Rif.	Off. Pubbico
PC301	7,97 €	1	6,98 €
PC301X4	7,57 €	4	6,63 €

Codice	Prezzo	Rif.	Off. Pubbico
PC309	15,68 €	1	13,72 €
PC309X2	14,89 €	2	13,03 €

Codice	Prezzo	Rif.	Off. Pubbico
PC306	27,32 €	1	23,90 €
PC306X2	25,95 €	2	22,71 €



Codice	Prezzo	Rif.	Off. Pubbico
SMQ	3,64 €		3,19 €

Codice	Prezzo	Rif.	Off. Pubbico
DCAL1626P	9,79 €		8,57 €

Codice	Prezzo	Rif.	Off. Pubbico
DPAC02	20,04 €		17,53 €



Chiave Per Codoli Radiatore Da 3/8" A 1"

Codice	Riferimenti	Prezzo	Off. Pubbico	Conf.	Box
CPCRM	41	30,36 €	26,57 €	1	12



Aspiratore da Muro ultra sottile APB101 4" 15\*15 15W QTA/036



Visualizza la gamma completa



Codice	Riferimenti	Prezzo	Off. Pubbico	Conf.	Box
APB101	15X15 CM.	17,07 €	14,94 €	1	12



Aspiratore da Muro 11a - 12 tubo D. 120 240 M/H 34 DB 19 W

Codice	Riferimenti	Prezzo	Off. Pubbico	Conf.	Box
8432011617700	D. 120	21,92 €	19,18 €	1	12
8432011617694	D. 150	24,32 €	21,28 €	1	12



Supporto per scabagno con gancio con tassello

Codice	Riferimenti	Prezzo	Off. Pubbico	Conf.	Box
SS100	8X70	0,72 €	0,63 €	1	12
SS140	10X140	1,56 €	1,36 €	1	13



Supporto per Sanitari Laterali

Codice	Riferimenti	Prezzo	Off. Pubbico	Conf.	Box
SSL	99	3,87 €	3,39 €	1	12



Pressatrice Manuale Profes.

Codice	Riferimenti	Prezzo	Off. Pubbico	Conf.	Box
PS000003	4	250,49 €	219,18 €	1	12



Pressatrice Professionale A Batteria Per Raccordi Tubi Multistrato Completa Di Inserti D. 16-20-26 Mm Con Profilo Th

Codice	Riferimenti	Prezzo	Off. Pubbico	Conf.	Box
PS000004	0	1.262,56 €	1.104,74 €	1	12



Giratugo per idraulici a 90° & 45°

Codice	Riferimenti	Prezzo	Off. Pubbico	Conf.	Box
G11\2190	D. 1" 90°	40,58 €	35,51 €	1	12
G2190	D. 2" 90°	59,28 €	51,87 €	1	12
GE145	D. 1" 45°	18,72 €	16,38 €	1	12
GE11\245	D. 1 1/2" 45°	28,70 €	25,11 €	1	12



Supporto per lavabo

Codice	Riferimenti	Prezzo	Off. Pubbico	Conf.	Box
SL140	140x10	1,57 €	1,37 €	1	12
SL180	180x10	1,85 €	1,62 €	1	13



Supporto sanitari a terra

Codice	Riferimenti	Prezzo	Off. Pubbico	Conf.	Box
SST	724	1,69 €	1,48 €	1	12



Sil 3004 Trasparente Antim.

Codice	Cod. Off.	Pz	Prezzo	Costo tot.	D.
TSTP	TSTP	1	€ 3,40	€ 3,40	3433
Listino	TSTPX30	30	€ 3,30	€ 98,96	
	TSTPX60	60	€ 3,23	€ 193,85	
	TSTPX120	120	€ 3,16	€ 379,53	



Sil 3004 Bianco Antimuffa

Codice	Cod. Off.	Pz	Off. Pubbico	Costo tot.	D.
TSBP	TSBP	1	€ 1,76	€ 1,76	2004
Listino	TSBPX30	30	€ 1,71	€ 51,22	
	TSBPX60	60	€ 1,67	€ 100,33	
	TSBPX120	120	€ 1,64	€ 196,43	



Batavia 7062507 18 V Agli Ioni Di Litio Per Sega A Gattuccio, 36 W 18V LI-ION SEGA ALTERNATIVA 0-3000 SPM LUNGHEZZA DEL

Codice	Riferimenti	Prezzo	Off. Pubbico	Conf.	Box
7062507	4	104,85 €	91,74 €	1	12



COMPRESSORE D'ARIA 18V, Colore: Grigio/Arancione

Codice	Riferimenti	Prezzo	Off. Pubbico	Conf.	Box
7063487	8	92,51 €	80,95 €	1	12



DECESPUGLIATORE 18 V AGLI IONI DI LITIO BATAVIA

Codice	Riferimenti	Prezzo	Off. Pubbico	Conf.	Box
7062516	1	84,52 €	73,96 €	1	12



Jig Saw Seghetto Alternativo Bat

Codice	Riferimenti	Prezzo	Off. Pubbico	Conf.	Box
7062513	5	67,88 €	59,39 €	1	12



Motosega Compatta Batavia

Codice	Riferimenti	Prezzo	Off. Pubbico	Conf.	Box
7063825	5	121,73 €	106,52 €	1	12



Idropulitrice A Batteria, 24 Bar, Senza Batteria/Caricabatterie

Codice	Riferimenti	Prezzo	Off. Pubbico	Conf.	Box
7063576	5	121,73 €	106,52 €	1	12



BATTERIA AGLI IONI DI LITIO 36W 18V 4 AH

Codice	Riferimenti	Prezzo	Off. Pubbico	Conf.	Box
7062518	20	77,46 €	67,77 €	1	12



FORBICI A BATTERIA BATAVIA 3,6V - Incl. Teste Di Taglio

Codice	Riferimenti	Prezzo	Off. Pubbico	Conf.	Box
7047996	2	42,59 €	37,27 €	1	12



Sega Circolare A Batteria 18V Maxxpack

Codice	Riferimenti	Prezzo	Off. Pubbico	Conf.	Box
7062508	2	109,56 €	95,86 €	1	12



Batavia 18V Batteria Utensile Multifunzione 7062510 Senza Caricabatteria

Codice	Riferimenti	Prezzo	Off. Pubbico	Conf.	Box
7062510	2	60,86 €	53,25 €	1	12



Batavia Bat7062511 Maxxpack 2 Modalità Trapano Sds 18V Nudo Unità

Codice	Riferimenti	Prezzo	Off. Pubbico	Conf.	Box
7062511	4	134,11 €	117,35 €	1	12



Motosega Compatta Batavia Completo Di Batteria E Copribatteria

Codice	Riferimenti	Prezzo	Off. Pubbico	Conf.	Box
7063824	6	199,00 €	174,12 €	1	12



Scala Telescopica Giraffe Air 3.27M | Con Softclose & Antiscivolo

Codice	Riferimenti	Prezzo	Off. Pubbico	Conf.	Box
7063596	5	219,11 €	191,72 €	1	12



COMPRESSORE D'ARIA 18V, Colore: Grigio/Arancione

Codice	Riferimenti	Prezzo	Off. Pubbico	Conf.	Box
7063487	8	92,51 €	80,95 €	1	12





Giraffe Air  
Telescoopladder 2,63M  
7063650 Batavia

Codice	Riferimenti	Prezzo	Off. Pubbico	Conf.	Box
7063650	5	170,43 €	149,13 €	1	12



Trapano Combinato Con  
Motore Senza Spazzole  
Batavia

Codice	Riferimenti	Prezzo	Off. Pubbico	Conf.	Box
7062722	2	219,13 €	191,74 €	1	12



Scala Telescopica In  
Alluminio, Altezza Di  
Lavoro (Max): 4,6 M, 3  
Colori, 15,3 Kg

Codice	Riferimenti	Prezzo	Off. Pubbico	Conf.	Box
7063088	4	304,34 €	266,30 €	1	12



Pompa Da Giardino 1500  
L/H 11 M - Batavia

Codice	Riferimenti	Prezzo	Off. Pubbico	Conf.	Box
7063549	4	109,49 €	95,80 €	1	12



SCALA A SFILLO IN  
ACCIAIO GR. 4+4

Codice	Riferimenti	Prezzo	Off. Pubbico	Conf.	Box
PRATIC4+4ACC	22	112,81 €	98,71 €	1	12



SCALA LIBELLULA 5  
GRADINI

Codice	Riferimenti	Prezzo	Off. Pubbico	Conf.	Box
S107A05W	20	71,94 €	62,95 €	1	12



SCALA A SFILLO IN  
ACCIAIO GR. 4+5

Codice	Riferimenti	Prezzo	Off. Pubbico	Conf.	Box
PRATIC4+5ACC	29	127,38 €	111,46 €	1	12



SCALA LIBELLULA 6  
GRADINI

Codice	Riferimenti	Prezzo	Off. Pubbico	Conf.	Box
S107A06W	19	84,07 €	73,56 €	1	12



SCALA A SFILLO IN  
ACCIAIO GR. 5+5

Codice	Riferimenti	Prezzo	Off. Pubbico	Conf.	Box
PRATIC5+5ACC	27	143,28 €	125,37 €	1	12



SCALA LIBELLULA 7  
GRADINI

Codice	Riferimenti	Prezzo	Off. Pubbico	Conf.	Box
S107A07W	6	105,40 €	92,23 €	1	12



SCALA LIBELLULA 4  
GRADINI

Codice	Riferimenti	Prezzo	Off. Pubbico	Conf.	Box
S107A04W	24	60,76 €	53,17 €	1	12



SCALA LIBELLULA 8  
GRADINI

Codice	Riferimenti	Prezzo	Off. Pubbico	Conf.	Box
S107A08W	16	120,88 €	105,77 €	1	12



SGABELLO STABILO 3  
GRADINI

Codice	Riferimenti	Prezzo	Off. Pubbico	Conf.	Box
G120L03W	27	41,73 €	36,52 €	1	12



SGABELLO STABILO 2  
GRADINI

Codice	Riferimenti	Prezzo	Off. Pubbico	Conf.	Box
G120L02W	35	31,79 €	27,81 €	1	12



Forno Casetta 81X103  
Sp.Lat. Kg. 6 X Uso  
Domestico



Codice	Riferimenti	Prezzo	Off. Pubbico	Conf.	Box
HS210	9	1.181,35 €	1.033,68 €	1	12

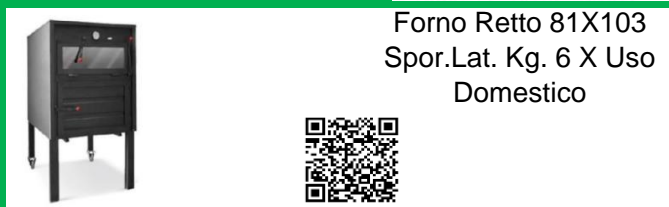

Forno Retto 81X103  
Spor.Lat. Kg. 6 X Uso  
Domestico



Codice	Riferimenti	Prezzo	Off. Pubbico	Conf.	Box
HS100	1	1.181,35 €	1.033,68 €	1	12

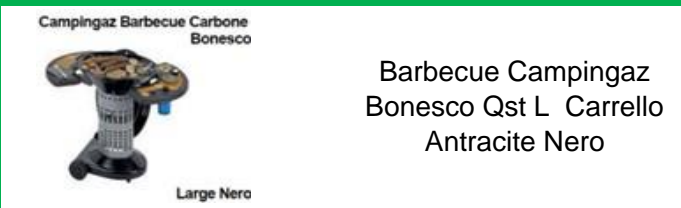

Barbecue Campingaz  
Bonesco Qst L Carrello  
Antracite Nero

Codice	Riferimenti	Prezzo	Off. Pubbico	Conf.	Box
3000001554	2	269,36 €	235,69 €	1	12

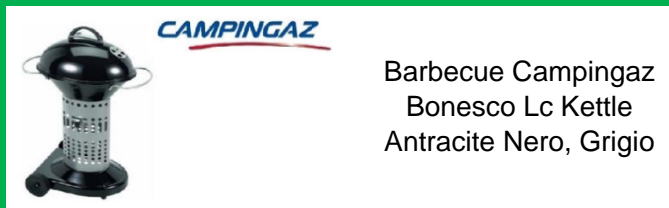

Barbecue Campingaz  
Bonesco Lc Kettle  
Antracite Nero, Grigio

Codice	Riferimenti	Prezzo	Off. Pubbico	Conf.	Box
3000001552	8	162,33 €	142,04 €	1	12

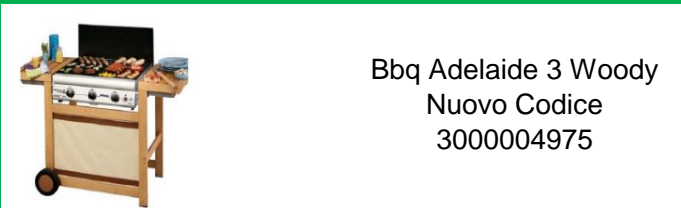

Bbq Adelaide 3 Woody  
Nuovo Codice  
3000004975

Codice	Riferimenti	Prezzo	Off. Pubbico	Conf.	Box
203431	18	295,52 €	258,58 €	1	12



Barbecue A Gas Pietra  
Lavica Da Esterno Bbq Da  
Giardino Con Coperchio  
Ruote E Fornello Laterale

Codice	Riferimenti	Prezzo	Off. Pubbico	Conf.	Box
3000002862	0	165,94 €	145,20 €	1	12

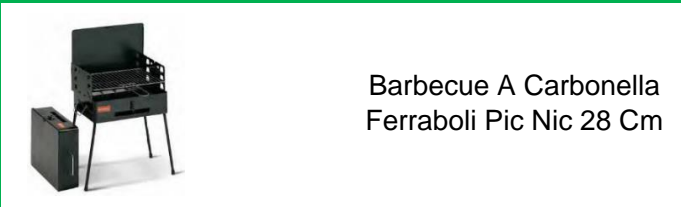

Barbecue A Carbonella  
Ferraboli Pic Nic 28 Cm

Codice	Riferimenti	Prezzo	Off. Pubbico	Conf.	Box
0000208	113	31,37 €	27,45 €	1	12

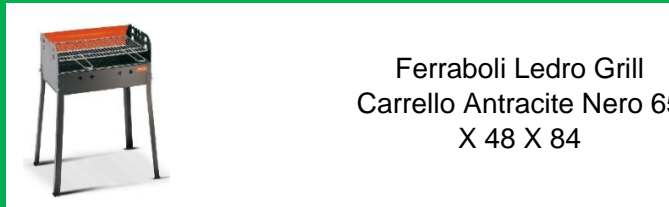

Ferraboli Ledro Grill  
Carrello Antracite Nero 65  
X 48 X 84

Codice	Riferimenti	Prezzo	Off. Pubbico	Conf.	Box
0000149	4	55,77 €	48,80 €	1	12

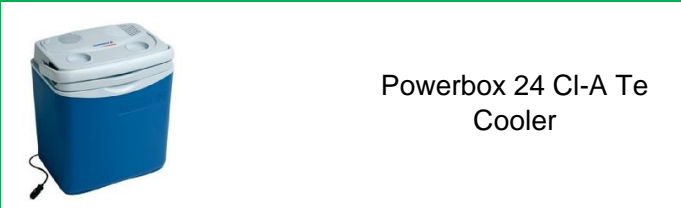

Powerbox 24 Cl-A Te  
Cooler

Codice	Riferimenti	Prezzo	Off. Pubbico	Conf.	Box
68679	13	86,21 €	75,43 €	1	12

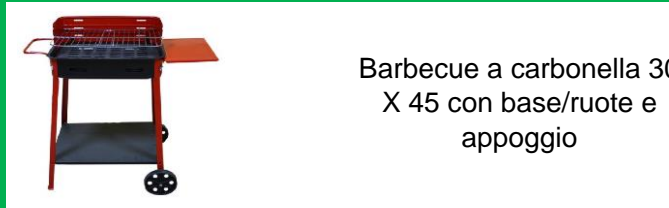

Barbecue a carbonella 30  
X 45 con base/ruote e  
appoggio

Codice	Riferimenti	Prezzo	Off. Pubbico	Conf.	Box
1068	31	65,06 €	56,93 €	1	12

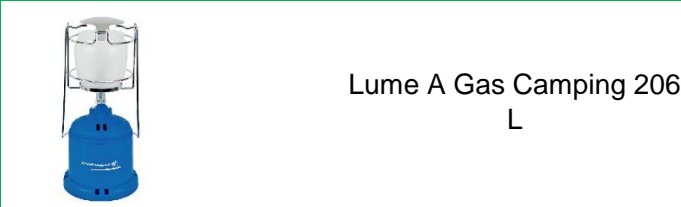

Lume A Gas Camping 206  
L

Codice	Riferimenti	Prezzo	Off. Pubbico	Conf.	Box
2000010189	17	27,07 €	23,69 €	1	12

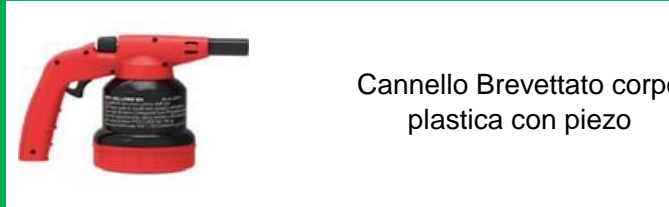

Cannello Brevettato corpo  
plastica con piezo

Codice	Riferimenti	Prezzo	Off. Pubbico	Conf.	Box
CPEH	278	16,21 €	14,19 €	1	12



Cartuccia Cp 250 Nuovo  
Cod.2000022384  
Cod. 2000034449

Codice	Riferimenti	Prezzo	Off. Pubbico	Conf.	Box
202208	4	3,99 €	3,49 €	1	12

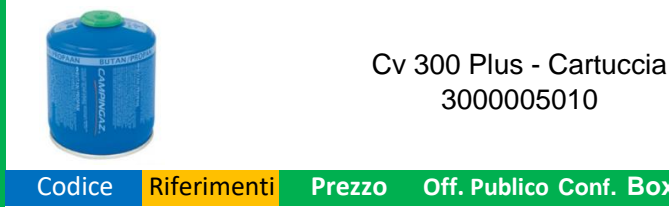

Cv 300 Plus - Cartuccia  
3000005010

Codice	Riferimenti	Prezzo	Off. Pubbico	Conf.	Box
203427	174	6,77 €	5,92 €	1	12



Set 10 Fascette Per Tubi

2x8 -18mm  
2x11-20mm  
2x13-23mm  
2x18-25mm  
2x14-27mm

Codice	Riferimenti	Prezzo	Off. Pubbico	Conf.	Box
770308	727	1,24 €	1,08 €	1	12



Set 6 Fascette Per Tubi

Codice	Riferimenti	Prezzo	Off. Pubbico	Conf.	Box
748310	1584	0,91 €	0,80 €	1	12



Fornellone Piccolo 30x30

bruciatore da 12,5cm  
30x30cm

Codice	Riferimenti	Prezzo	Off. Pubbico	Conf.	Box
792600	48	21,31 €	18,64 €	1	12



Fornellone Cm 30X30X13  
Con Bruciatore In Ghisa  
Kw 3,5 Omologato Ce

Codice	Riferimenti	Prezzo	Off. Pubbico	Conf.	Box
600CE	18	29,64 €	25,93 €	1	12



Girella 3 Bracci Orientabili

Codice	Riferimenti	Prezzo	Off. Pubbico	Conf.	Box
33425001	12	12,12 €	10,60 €	1	12



Giunto Riparatore 1/2"-5  
/8

Codice	Riferimenti	Prezzo	Off. Pubbico	Conf.	Box
33320001	39	2,73 €	2,39 €	1	12



Giunto Riparatore 5 /8-3/4"

Codice	Riferimenti	Prezzo	Off. Pubbico	Conf.	Box
33325001	23	3,19 €	2,79 €	1	12



Cartuccia Gas Da 190 Gr.



Codice	Riferimenti	Prezzo	Off. Pubbico	Conf.	Box
CG190	4155	1,71 €	1,50 €	1	12



Chiave Bombola Da 25

Import Export

Codice	Riferimenti	Prezzo	Off. Pubbico	Conf.	Box
CB25	232	1,67 €	1,46 €	1	12



Fornellone Grande 40x40

bruciatore da 17,5cm  
40x40CM

Codice	Riferimenti	Prezzo	Off. Pubbico	Conf.	Box
792601	31	29,67 €	25,96 €	1	12



Fornellone Cm 40X40X19  
Con Bruciatore In Ghisa  
Kw 8,5 Omologato Ce

Codice	Riferimenti	Prezzo	Off. Pubbico	Conf.	Box
230CE	22	41,66 €	36,45 €	1	12



Set 5 Giraviti Unior - 4,01  
5,5X1,25 6,5X 150 + 1X80

- 4.0x100; 5.5x125;  
6.5x180;  
+ 1x80; 2x100;

Codice	Riferimenti	Prezzo	Off. Pubbico	Conf.	Box
609CS5BI	128	17,43 €	15,25 €	1	12



Irrigatore 360°Turbina  
Fisso

33.435.001

Codice	Riferimenti	Prezzo	Off. Pubbico	Conf.	Box
33435001	8	21,08 €	18,44 €	1	12



Giunto Ripar.Uni.1/2"-5 /8-  
3/4"

Codice	Riferimenti	Prezzo	Off. Pubbico	Conf.	Box
33330001	10	4,00 €	3,50 €	1	12





Raccordo 1/2"-5/8 Fermo Sicu.

Codice	Riferimenti	Prezzo	Off. Pubbico	Conf.	Box
33305001	33	4,91 €	4,30 €	1	12



Raccordo 5/8-3/4 Fermo Sic.

Codice	Riferimenti	Prezzo	Off. Pubbico	Conf.	Box
33310001	0	4,38 €	3,83 €	1	12



Avvolgitubo C/Stand

Codice	Riferimenti	Prezzo	Off. Pubbico	Conf.	Box
538206	12	31,43 €	27,50 €	1	12



Doccia Da Giardino C/Base 2,25 Mt

Codice	Riferimenti	Prezzo	Off. Pubbico	Conf.	Box
538201	22	20,67 €	18,09 €	1	12



Irrigatore Multifunzione

Codice	Riferimenti	Prezzo	Off. Pubbico	Conf.	Box
770316	19	4,83 €	4,22 €	1	12



Raccordo 1/2"-5/8-3/4 Fermo

Codice	Riferimenti	Prezzo	Off. Pubbico	Conf.	Box
33315001	7	4,55 €	3,99 €	1	12



Tubo Garden 6 Strati 3/4 Mt. 25

Codice	Riferimenti	Prezzo	Off. Pubbico	Conf.	Box
33040001	15	67,56 €	59,11 €	1	12



Tubo Garden 6 Strati 1/2 Mt. 15

Codice	Riferimenti	Prezzo	Off. Pubbico	Conf.	Box
33010001	17	20,57 €	17,99 €	1	12



Tubo Garden 6 Strati 1/2 Mt. 25

Codice	Riferimenti	Prezzo	Off. Pubbico	Conf.	Box
33015001	11	34,33 €	30,04 €	1	12



Irrigatore Rotante

Codice	Riferimenti	Prezzo	Off. Pubbico	Conf.	Box
770315	30	4,20 €	3,68 €	1	12



Irrigatore X Giardino A Settore

Codice	Riferimenti	Prezzo	Off. Pubbico	Conf.	Box
516892	72	5,69 €	4,98 €	1	12



Irrigatore X Giardino A Settore

Codice	Riferimenti	Prezzo	Off. Pubbico	Conf.	Box
516890	68	3,96 €	3,47 €	1	12



Irrigatore X Giardino Rot.

Codice	Riferimenti	Prezzo	Off. Pubbico	Conf.	Box
516891	92	2,86 €	2,50 €	1	12



Lancia C/Getto Regolabile

Codice	Riferimenti	Prezzo	Off. Pubbico	Conf.	Box
770363	3	7,64 €	6,68 €	1	12



Ala Gocciolante Ø16Mm 2  
Lt/H 30Cm 100M

Codice	Riferimenti	Prezzo	Off. Pubbico	Conf.	Box
431160230100	4500	0,42 €	0,37 €	1	12



Gomito Per Ala Con  
Anellino Ø 16

Codice	Riferimenti	Prezzo	Off. Pubbico	Conf.	Box
9980016000	990	0,51 €	0,45 €	1	12



Manicotto Ala

Codice	Riferimenti	Prezzo	Off. Pubbico	Conf.	Box
MAALA	1620	0,49 €	0,43 €	1	12



Raccordo Maschio Per  
Ala Con Anellino Ø  
16X1/2

Codice	Riferimenti	Prezzo	Off. Pubbico	Conf.	Box
991401600B	800	0,36 €	0,32 €	1	12



Raccordo Maschio Per  
Ala Con Anellino Ø  
16X3/4

Codice	Riferimenti	Prezzo	Off. Pubbico	Conf.	Box
991401600C	790	0,36 €	0,32 €	1	12



Tee Per Ala Con Anellino  
Ø 16

Codice	Riferimenti	Prezzo	Off. Pubbico	Conf.	Box
9950016000	590	0,61 €	0,54 €	1	12



Raccordo Per Tubi 1/2"

Codice	Riferimenti	Prezzo	Off. Pubbico	Conf.	Box
515235	236	0,66 €	0,58 €	1	12



Lancia Erogatrice

Codice	Riferimenti	Prezzo	Off. Pubbico	Conf.	Box
770360	189	1,29 €	1,13 €	1	12



Lancia Erogatrice

Codice	Riferimenti	Prezzo	Off. Pubbico	Conf.	Box
770283	48	1,68 €	1,47 €	1	12



Pistola Da Giardino 9  
Getti

Codice	Riferimenti	Prezzo	Off. Pubbico	Conf.	Box
538210	87	8,94 €	7,83 €	1	12



Pistola Erogatore Per  
Tubo Da

Codice	Riferimenti	Prezzo	Off. Pubbico	Conf.	Box
770281	41	3,63 €	3,17 €	1	12



Pistola Erogatore Per  
Tubo Da

Codice	Riferimenti	Prezzo	Off. Pubbico	Conf.	Box
770282	79	4,15 €	3,63 €	1	12



Pistola Erogatrice

Codice	Riferimenti	Prezzo	Off. Pubbico	Conf.	Box
770358	8	9,78 €	8,56 €	1	12



Raccordo Per Tubi 3/4"

Codice	Riferimenti	Prezzo	Off. Pubbico	Conf.	Box
515236	276	0,91 €	0,80 €	1	12

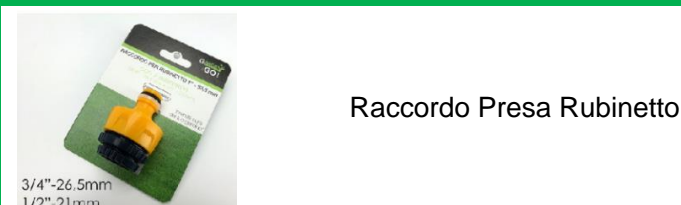

Raccordo Presa Rubinetto

3/4"-26,5mm  
1/2"-21mm

Codice	Riferimenti	Prezzo	Off. Pubbico	Conf.	Box
770355	67	1,24 €	1,08 €	1	12



Raccordo Presa Rubinetto

3/4"-26,5mm  
1/2"-21mm

Codice	Riferimenti	Prezzo	Off. Pubbico	Conf.	Box
770357	10	3,39 €	2,96 €	1	12



Raccordo Presa Rubinetto  
2 Vie

Codice	Riferimenti	Prezzo	Off. Pubbico	Conf.	Box
515238	109	0,96 €	0,84 €	1	12



Raccordo Rapido

1/2" - 13MM

Codice	Riferimenti	Prezzo	Off. Pubbico	Conf.	Box
770354	419	1,24 €	1,08 €	1	12



Raccordo Rapido A  
Innesto 1/2"

1/2" - 13MM

Codice	Riferimenti	Prezzo	Off. Pubbico	Conf.	Box
515237	417	1,24 €	1,08 €	1	12



Raccordo Rapido Acqua  
Stop

1/2" - 13MM

Codice	Riferimenti	Prezzo	Off. Pubbico	Conf.	Box
770354A	256	1,24 €	1,08 €	1	12



Raccordo Rapido Acqua  
Stop 1/2"

CON ACQUA STOP  
per tubo da 1/2" - 13mm

Codice	Riferimenti	Prezzo	Off. Pubbico	Conf.	Box
515237A	252	1,24 €	1,08 €	1	12



Raccordo Rubinetto 3/4" -  
1/2"

3/4"-26,5mm  
1/2"-21mm

Codice	Riferimenti	Prezzo	Off. Pubbico	Conf.	Box
515234	127	1,11 €	0,97 €	1	12

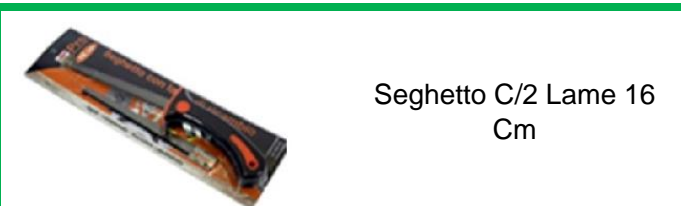

Seghetto C/2 Lama 16  
Cm

Codice	Riferimenti	Prezzo	Off. Pubbico	Conf.	Box
770147	9	5,53 €	4,84 €	1	12



Set 3 Pz Giardinaggio

21cm

Codice	Riferimenti	Prezzo	Off. Pubbico	Conf.	Box
747849	81	2,04 €	1,79 €	1	12

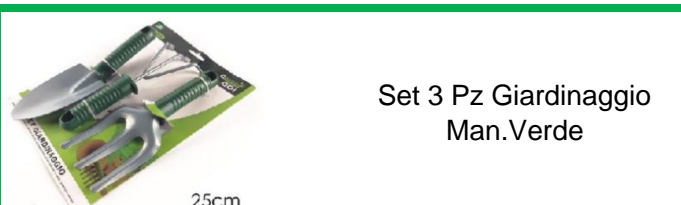

Set 3 Pz Giardinaggio  
Man.Verde

25cm

Codice	Riferimenti	Prezzo	Off. Pubbico	Conf.	Box
747850	26	2,04 €	1,79 €	1	12



Set 3 Raccordi  
C/Erogatore Per

Codice	Riferimenti	Prezzo	Off. Pubbico	Conf.	Box
770280	162	2,73 €	2,39 €	1	12

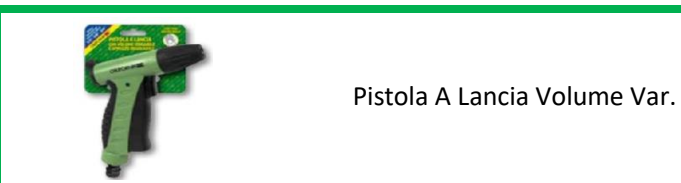

Pistola A Lancia Volume Var.

Codice	Riferimenti	Prezzo	Off. Pubbico	Conf.	Box
33405001	3	14,25 €	12,46 €	1	12



Racc.5/8-3/4 Fermo Acqua  
Stop

Codice	Riferimenti	Prezzo	Off. Pubbico	Conf.	Box
33310102	4	5,67 €	4,96 €	1	12





Giunto Riparatore 5 /8-3/4"

Codice	Riferimenti	Prezzo	Off. Pubbico	Conf.	Box
33325001	23	3,19 €	2,79 €	1	12



Irrigatore 360° Turbina Slit.

Codice	Riferimenti	Prezzo	Off. Pubbico	Conf.	Box
33430001	16	27,05 €	23,67 €	1	12



Irrigatore 9 Figure C/Pop Up

Codice	Riferimenti	Prezzo	Off. Pubbico	Conf.	Box
33420001	11	17,76 €	15,54 €	1	12



Tubo Estensibile 15 Mt C/Pistola 7

Codice	Riferimenti	Prezzo	Off. Pubbico	Conf.	Box
538219	5	24,76 €	21,66 €	1	12



Tubo Giallo Da Giardino

Codice	Riferimenti	Prezzo	Off. Pubbico	Conf.	Box
805800	10 mt	8,17 €	7,15 €	1	12
805801	15 mt	10,91 €	9,54 €	1	12
805802	20 mt	14,60 €	12,77 €	1	12



Tubo giardino completo di Pistola + Accessori.

Codice	Riferimenti	Prezzo	Off. Pubbico	Conf.	Box
692910	10 mt	8,55 €	7,48 €	1	
692907	15 mt	13,36 €	11,69 €	1	
692905	20 mt	17,08 €	14,94 €	1	
692906	30 mt	22,04 €	19,28 €	1	



Irrigatore 360° Turbina Fisso

Codice	Riferimenti	Prezzo	Off. Pubbico	Conf.	Box
33435001	8	21,08 €	18,44 €	1	12



Irrigatore 8 Figure

Codice	Riferimenti	Prezzo	Off. Pubbico	Conf.	Box
33415001	12	9,67 €	8,46 €	1	12



Lancia C/Spruo Regolabile Zx

Codice	Riferimenti	Prezzo	Off. Pubbico	Conf.	Box
33400001	9	6,71 €	5,87 €	1	12

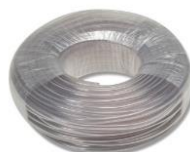

Tubo Antigelo 1 Prezzo al Kg.

Codice	Riferimenti	Prezzo	Off. Pubbico	Conf.	Box
TA14X19	375,72	5,44 €	4,76 €	1	Rt
TA18X24	375	5,44 €	4,76 €	1	Rt



Fascetta Stringitubo conf. 100 Pz

Codice	Riferimenti	Prezzo	Off. Pubbico	Conf.	Box
FS14-18	37	19,72 €	17,25 €	100	Sc
FS20-32	19	24,55 €	21,48 €	100	Sc



Cazzuola Pt 18 Progrid

Codice	Riferimenti	Prezzo	Off. Pubbico	Conf.	Box
123601	180	8,32 €	7,28 €	1	12



Martello Carpentiere Gr. 300 Faggio Expo

Codice	Riferimenti	Prezzo	Off. Pubbico	Conf.	Box
3004A	59	5,47 €	4,78 €	1	12



Martellina Catania Gr.400

Codice	Riferimenti	Prezzo	Off. Pubbico	Conf.	Box
110820	44	7,29 €	6,38 €	1	12



Metro Avvolgibile Mt. 2

Codice	Riferimenti	Prezzo	Off. Pubbico	Conf.	Box
748082	83	0,86 €	0,75 €	1	12



Cazzuolino Foglio Ulivo Cm.14 Expo

Codice	Riferimenti	Prezzo	Off. Pubbico	Conf.	Box
3062A	60	2,83 €	2,48 €	1	12



Set 5 Giraviti Unior - 4,01  
5,5X1,25 6,5X 150 + 1X80

Codice	Riferimenti	Prezzo	Off. Pubbico	Conf.	Box
609CS5BI	128	17,43 €	15,25 €	1	12



Imbuto Flessibile Con Filtro

Codice	Riferimenti	Prezzo	Off. Pubbico	Conf.	Box
749103	214	1,37 €	1,20 €	1	12



Cazzuolino Foglio Olivo Cm.14

Codice	Riferimenti	Prezzo	Off. Pubbico	Conf.	Box
123473	60	4,53 €	3,96 €	1	12



Martello Carpentiere Gr. 300 In Fibbra Expo

Codice	Riferimenti	Prezzo	Off. Pubbico	Conf.	Box
3004B	45	8,10 €	7,08 €	1	12



Mazzetta Club C/M Gr. 1000

Codice	Riferimenti	Prezzo	Off. Pubbico	Conf.	Box
10145	23	12,71 €	11,12 €	1	12



Mazzetta Master Gr.1000 Progrid

Codice	Riferimenti	Prezzo	Off. Pubbico	Conf.	Box
10143	13	15,26 €	13,35 €	1	12



Cazzuola P.T. 19.1 Ghiera

Codice	Riferimenti	Prezzo	Off. Pubbico	Conf.	Box
123341	66	7,51 €	6,58 €	1	12



Tubo Per Travaso

Codice	Riferimenti	Prezzo	Off. Pubbico	Conf.	Box
749104	98	1,24 €	- €	1	12



Pinza Manici Super Grip Da 200

Codice	Riferimenti	Prezzo	Off. Pubbico	Conf.	Box
406BI	44	10,36 €	9,06 €	1	12



Scaldaletto Matrimoniale  
Misto Lana 150X160Cm

Codice	Riferimenti	Prezzo	Off. Pubbico	Conf.	Box
AR423	68	92,60 €	81,02 €	1	6



Scaldaletto Singolo Misto  
Lana 150X80Cm

Codice	Riferimenti	Prezzo	Off. Pubbico	Conf.	Box
AR412	34	55,31 €	48,40 €	1	6



Scaldaletto Singolo  
150X80Cm

Codice	Riferimenti	Prezzo	Off. Pubbico	Conf.	Box
AR4U80	16	31,26 €	27,36 €	1	6



Ardes Tikappa Scaldaletto  
Matrimoniale 2 Temperatura  
160X140

Codice	Riferimenti	Prezzo	Off. Pubbico	Conf.	Box
AR4U140	11	52,91 €	46,30 €	1	6



Termoventilatore Ceramico  
Murale, Display Led, Con  
Telecomando. Potenza  
2000W

Codice	Riferimenti	Prezzo	Off. Pubbico	Conf.	Box
AR4W01	8	48,31 €	42,27 €	1	1



Termoventilatore Ceramico  
Ardes

Codice	Riferimenti	Prezzo	Off. Pubbico	Conf.	Box
AR4W02	11	42,80 €	37,45 €	1	4



Ardes Termoventilatore  
Verticale Con Progr. Gior.  
P.1000/2000W

Codice	Riferimenti	Prezzo	Off. Pubbico	Conf.	Box
AR449TI	5	32,88 €	28,77 €	1	6



Ardes Termoventilatore  
1000/2000W

Codice	Riferimenti	Prezzo	Off. Pubbico	Conf.	Box
AR451B	-	15,64 €	13,68 €	1	6



Ardes Termoventilatore  
Caldobagno Ip21

Codice	Riferimenti	Prezzo	Off. Pubbico	Conf.	Box
AR4F06T	19	53,63 €	46,93 €	1	6



Stufa Alogena Con 3  
Elementi Riscaldanti, Nera

Codice	Riferimenti	Prezzo	Off. Pubbico	Conf.	Box
AR454B	32	30,85 €	27,00 €	1	4



Ardes Stufa Al Carbonio  
900W Oscillante/Basculante

Codice	Riferimenti	Prezzo	Off. Pubbico	Conf.	Box
AR4B02	5	64,46 €	56,40 €	1	4



Stufe a Gas da Interno  
infrarossi; 3 livelli di potenza;  
sensore ODS; classe A KW 4.2

**Qlima PROMO**



Codice	Riferimenti	Prezzo	Off. Pubbico	Conf.	Box
GH1142R	23	130,38 €	114,08 €	1	12



Sole Mio Scaldino Elettrico  
550W Con Lampada Spia,  
Bronzo

Codice	Riferimenti	Prezzo	Off. Pubbico	Conf.	Box
AR71	35	31,39 €	27,47 €	1	



Radiatore 9 Elementi  
"Kompact" Compatto

Codice	Riferimenti	Prezzo	Off. Pubbico	Conf.	Box
S719	23	28,35 €	24,80 €	1	



Serie Dream con Piedi  
Mobile comprendente: Mobile 2 Ante cm. 60-80-100, Lavabo, Specchio Reversibile montato su base in legno(senza luce) cm. 60X80



Articolo	Colori	Prezzo
DREAM60APPSI	Signal	283,25 €
DREAM80APPSI	Signal	302,07 €
DREAM100APPSI	Signal	385,30 €
<b>Specchio da Bagno Reversibile senza led</b>		
SP60-80	60x80	67,39 €
SP80-100	80x100	85,97 €

Serie Eirene Con Piedi  
MOBILE EIRENE 2 CASSETTI 60 SOSPESO + LAVABO + Specchio Reversibile montato su base in legno(senza luce) cm. 60X80



Articolo	Colori	Prezzo
EIRENE80APP3CSI	Signal	398,97 €
EIRENE100APP3CSI	Signal	479,21 €

Serie Dream Con Sospeso  
Mobile comprendente: Mobile 2 Ante cm. 60, Lavabo, Specchio Reversibile montato su base in legno(senza luce) cm. 60X80



Articolo	Colori	Prezzo
DREAM60SI	Signal	247,89 €
DREAM80SI	Signal	271,48 €

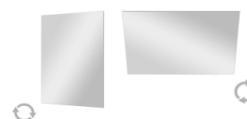

Serie Eirene Sospeso  
MOBILE EIRENE 2 CASSETTI 60 SOSPESO + LAVABO + Specchio Reversibile montato su base in legno(senza luce) cm. 60X80



Articolo	Colori	Prezzo
EIRENE60SI	Signal	295,08 €
EIRENE80SI	Signal	336,93 €
EIRENE100SI	Signal	385,30 €

MOBILE BAGNO FLY 80  
MOBILE bagno in composizione: Lavabo, Completo di 2 mobili cassettoni, Colonna 2 Ante con chiusura soft + Specchio Reversibile montato su base in legno(senza luce) cm. 60X80



Articolo	Colori	Prezzo
FLY80SI	Signal	487,97 €

Colonna Dream H.  
112 Largo 33 Profondo 30  
Colonna 2 Ante chiusura Rallentata, Reversibile apertura sportello DX o Sx



Articolo	Colori	Prezzo
COLDREAMSI	Signal	101,52 €
COLDREAMBT	Bianco Titanio	101,52 €
COLDREAMBE	Bengala	101,52 €
COLDREAMDV	Dolce Vita	101,52 €
COLDREAMOS	Ossido	101,52 €
COLDREAMSH	Sherwood	101,52 €

Cubo Dream con Anta apertura Push  
Cubo Dream H. 45 Largo 45 Profondo 15



Articolo	Colori	Prezzo
CUBOSI	Signal	57,86 €
CUBOBT	Bianco Titanio	57,86 €
CUBOBE	Bengala	57,86 €
CUBODV	Dolce Vita	57,86 €
CUBOOS	Ossido	57,86 €
CUBOSH	Sherwood	57,86 €



N.B. Prodotti Su Ordine  
10/15 Giorni Lavorazione

SI Signal  
BT Bianco Titanio  
BE Bengala  
DV Dolce Vita  
OS Ossido  
SH Sherwood



Specchio da bagno con 2 ante  
larghezza sportello cm. 17,5 Altezza Specchio cm. 57, Larghezza dello specchio cm. 80, Profondità cm. 14, Due Luci a led



Articolo	Colori	Prezzo
SMILE80SI	Signal	102,24 €
SMILE80BT	Bianco Titanio	102,24 €
SMILE80BE	Bengala	102,24 €
SMILE80DV	Dolce Vita	102,24 €
SMILE80OS	Ossido	102,24 €
SMILE80SH	Sherwood	102,24 €

Specchio da bagno con 1 anta  
larghezza sportello cm. 17,5 Altezza Specchio cm. 57, Larghezza dello specchio cm. 60, Profondità cm. 14, Due Luci a led



Articolo	Colori	Prezzo
JOY60SI	Signal	89,46 €
JOY60BT	Bianco Titanio	89,46 €
JOY60BE	Bengala	89,46 €
JOY60DV	Dolce Vita	89,46 €
JOY60OS	Ossido	89,46 €
JOY60SH	Sherwood	89,46 €



11) Colonna Dream Aperta 2 Ripiani

Articolo	Colori	Prezzo
CDA2RSI	Signal	98,68 €

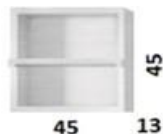

4) Cubo Dream Aperto

Articolo	Colori	Prezzo
CAD1MSI	Signal	53,13 €



1) Colonna Sospesa Slim con Apertura Push Reversibile

Articolo	Colori	Prezzo
CSSP80SI	Signal	103,74 €



2) Mezza Colonna Slim CM. 60 Apertura Dx Su Richiesta Sx

Articolo	Colori	Prezzo
CSSP60DXSI	Signal	101,21 €



8) Mezza Colonna Slim CM. 60 Apertura Dx Su Richiesta Sx

Articolo	Colori	Prezzo
CSP60DXSI	Signal	96,15 €



6) Colonna Dream Sospesa 2 Ante Reversibile

Articolo	Colori	Prezzo
CD2ARSI	Signal	116,39 €



Modello Sigma- Specchio Argentato Senza Rame da 5 mm - Sensore Touch per Accensione-Struttura in Alluminio-Luce 6000 K-230V / 50 hz

Codice	Riferimento	Prezzo
SIGMA60	D. 60	156,87 €
SIGMA70	D. 70	179,64 €
SIGMA80	D. 80	156,87 €



Modello Delta- Specchio Argentato Senza Rame da 5 mm - Sensore Touch per Accensione-Struttura in Alluminio-Luce 6000 K-230V / 50 hz

Codice	Riferimento	Prezzo
DELTA6080	D. 60x80	165,22 €
DELTA70100	D. 70x100	201,15 €

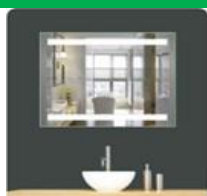

Modello Beta- Specchio Argentato Senza Rame da 5 mm - Sensore Touch per Accensione-Struttura in Alluminio-Luce 6000 K-230V / 50 hz

Codice	Riferimento	Prezzo
BETA6080	D. 60x80	172,31 €
BETA70100	D. 70x100	197,35 €



5) Colonna Dream Aperta Con Mensola

Articolo	Colori	Prezzo
CDA1RSI	Signal	96,15 €



4M) Cubo Dream Aperto Con Mensola

Articolo	Colori	Prezzo
CADSI	Signal	50,60 €



3) Colonna Sospesa Slim con Apertura Push Reversibile

Articolo	Colori	Prezzo
CSSP60DXSI	Signal	101,21 €



7) Colonna Dream Sospesa CM. 56 1 Anta

Articolo	Colori	Prezzo
CSSP56SI	Signal	101,21 €



9) Base Multiuso con Cassetto più Sportello

Articolo	Colori	Prezzo
BMC56SI	Signal	111,33 €



10) Colonna con piedini Multiuso 2 Sportelli + Cassetto

Articolo	Colori	Prezzo
CD2A1C168SI	Signal	194,82 €



Modello Paint- Specchio Argentato Senza Rame da 5 mm - Sensore Touch per Accensione-Struttura in Alluminio-Luce 6000 K-230V / 50 hz

Codice	Riferimento	Prezzo
PAINT6080	D. 60x80	€ 79,07
PAINT70100	D. 70x100	€ 90,71

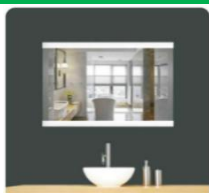

Modello Omega- Specchio Argentato Senza Rame da 5 mm - Sensore Touch per Accensione-Struttura in Alluminio-Luce 6000 K-230V / 50 hz

Codice	Riferimento	Prezzo
OMEGA6080	D. 60x80	169,02 €
OMEGA70100	D. 70x100	193,56 €

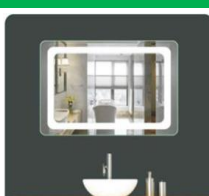

Modello Alfa- Specchio Argentato Senza Rame da 5 mm - Sensore Touch per Accensione-Struttura in Alluminio-Luce 6000 K-230V / 50 hz

Codice	Riferimento	Prezzo
ALFA6080	D. 60x80	176,86 €
ALFA70100	D. 70x100	201,15 €

## LAVATOIO 80X50 BASIC CON PIEDINI E STROFINATOIO IN

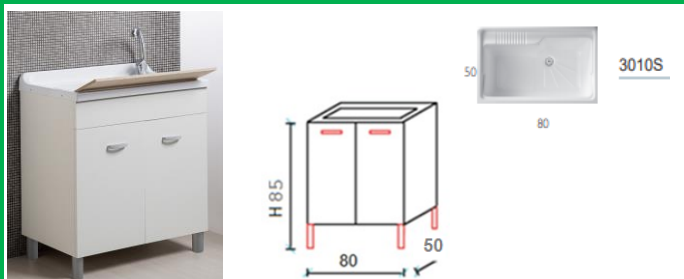

Codice	Riferimenti	Prezzo	Off. Pubbico	Conf.	Box
BB85		206,80 €	180,95 €	1	12

## LAVATOIO 60X60 BASIC CON PIEDINI E STROFINATOIO IN

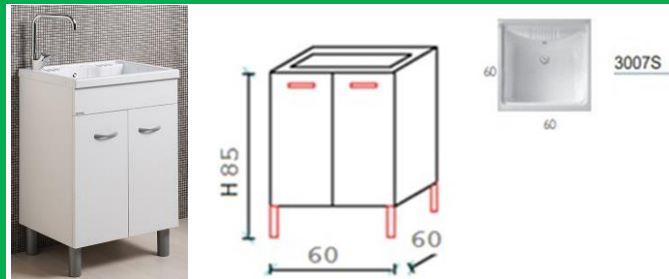

Codice	Riferimenti	Prezzo	Off. Pubbico	Conf.	Box
BB66		133,96 €	117,21 €	1	12

## LAVATOIO 50X50 BASIC CON PIEDINI E STROFINATOIO IN

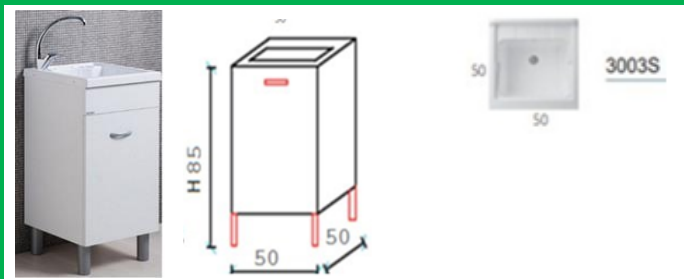

Codice	Riferimenti	Prezzo	Off. Pubbico	Conf.	Box
BB55		128,73 €	112,64 €	1	12

## LAVATOIO 60X50 BASIC CON PIEDINI E STROFINATOIO IN

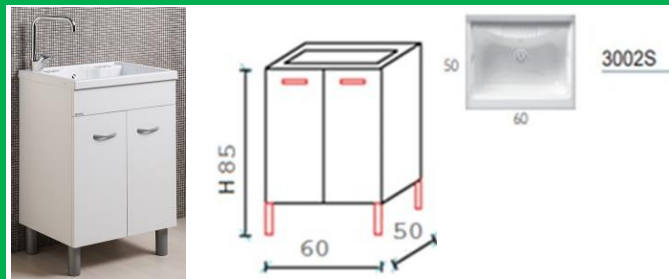

Codice	Riferimenti	Prezzo	Off. Pubbico	Conf.	Box
BB65		131,36 €	114,94 €	1	12

## LAVATOIO 45X50 BASIC CON PIEDINI E STROFINATOIO IN

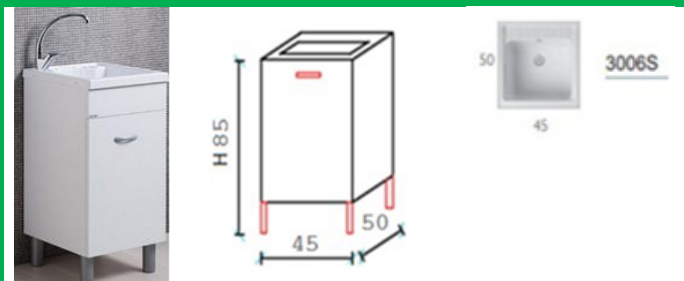

Codice	Riferimenti	Prezzo	Off. Pubbico	Conf.	Box
BB54		127,68 €	111,72 €	1	12

## LAVATOIO 45X60 BASIC CON PIEDINI E STROFINATOIO IN

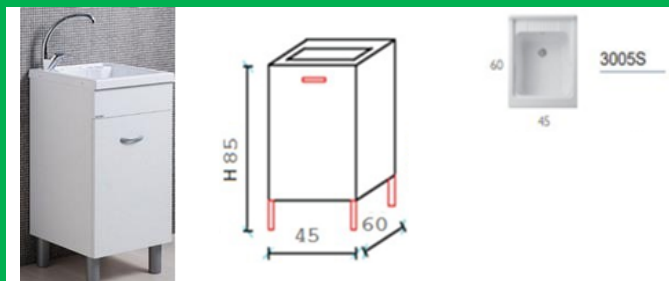

Codice	Riferimenti	Prezzo	Off. Pubbico	Conf.	Box
BB64		164,51 €	143,95 €	1	12



Linea Coprilavatrice	Riferimenti	Riferimenti	Prezzo	Off. Pubbico	Conf.	Box
Lav. dx	CL64D	60X109XH90	229,88 €	201,14 €		12
Lav. Sx	CL64S	60X109XH90	229,88 €	201,14 €		12
Lav. dx	CL66D	60X124XH90	243,98 €	213,48 €		12
Lav. Sx	CL66S	60X124XH90	243,98 €	213,48 €		12



Mobile Portalavatrice, in nobilitato classe E1 da 1,8 bordo colle poliuretaniche, vasca ABS completo di sifone.



**LAVATOIO PVC C/SPORT. 45X50 ZZ**

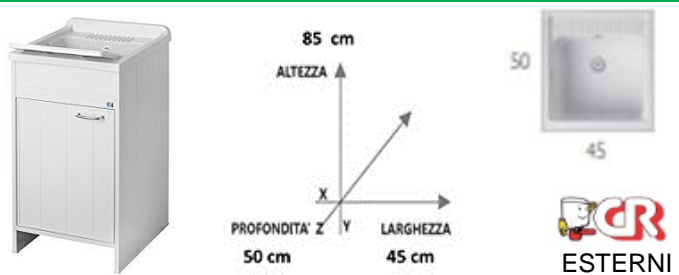

Codice	Riferimenti	Prezzo	Off. Pubbico	Conf.	Box
9006K		99,74 €	87,27 €	1	12

**LAVATOIO PVC C/SPORT. 50X50 ZZ**

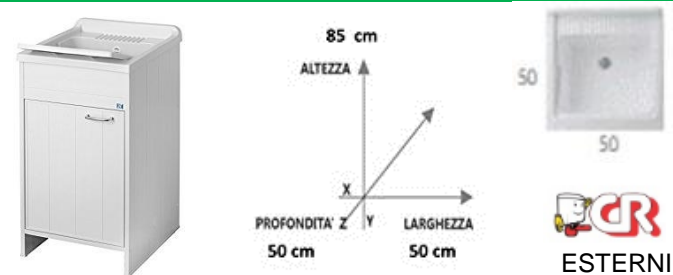

Codice	Riferimenti	Prezzo	Off. Pubbico	Conf.	Box
9003K		99,74 €	87,27 €	1	12

**LAVATOIO PVC C/SPORT. 60X60 ZZ**

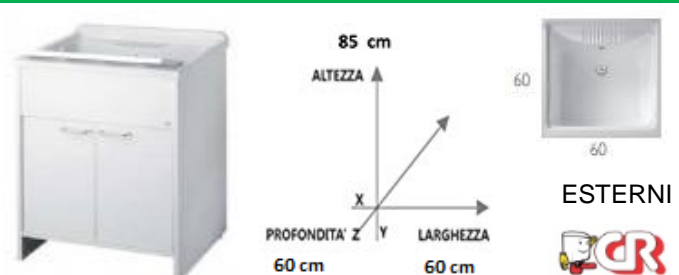

Codice	Riferimenti	Prezzo	Off. Pubbico	Conf.	Box
9007K		124,67 €	109,09 €	1	12

**LAVATOIO PVC C/SPORT. 60X50 ZZ**

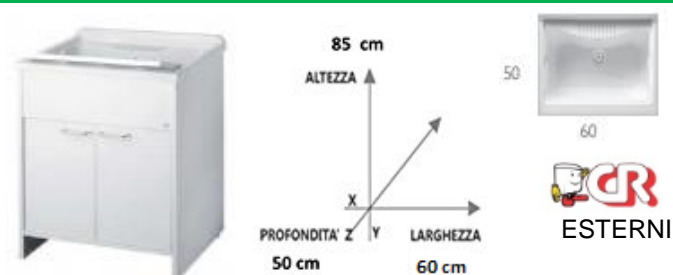

Codice	Riferimenti	Prezzo	Off. Pubbico	Conf.	Box
9002K		112,21 €	98,18 €	1	12

**Sottolavelli con cassetti 120x50 Bianco cassettiera DX**



Codice	Riferimenti	Prezzo	Off. Pubbico	Conf.	Box
CL120CBDX		257,23 €	225,07 €	1	12

**Sottolavelli con cassetti 120x50 Bianco cassettiera SX**



Codice	Riferimenti	Prezzo	Off. Pubbico	Conf.	Box
CL120CBSX		257,23 €	225,07 €	1	12

**Sottolavelli con cassetti 120x50 Teck cassettiera DX**



Codice	Riferimenti	Prezzo	Off. Pubbico	Conf.	Box
CL120CTDX		257,23 €	225,07 €	1	12

**Sottolavelli con cassetti 120x50 Teck cassettiera SX**



Codice	Riferimenti	Prezzo	Off. Pubbico	Conf.	Box
CL120CTSX		257,23 €	225,07 €	1	12

**Sottolavelli 80x50 TECK Lavello inox 80X50 1 vasche piu'**

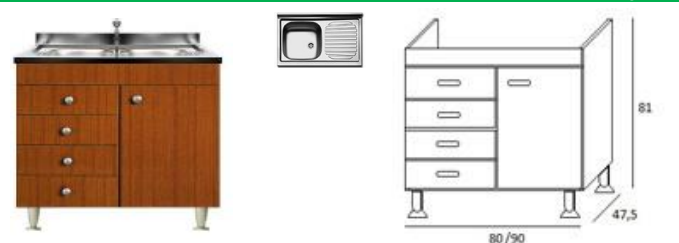

Codice	Riferimenti	Prezzo	Off. Pubbico	Conf.	Box
CL80CTL		220,04 €	192,54 €	1	12
CL80CTLD		220,04 €	192,54 €	1	12

**Sottolavelli 80x50 Bianco Lavello inox 80X50 1 vasche**

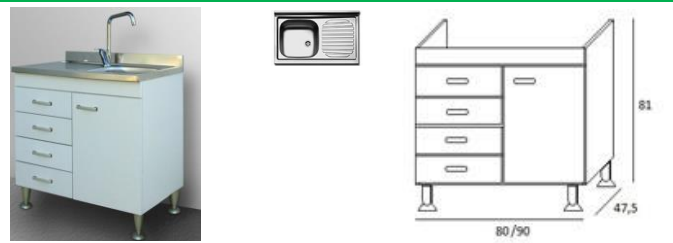

Codice	Riferimenti	Prezzo	Off. Pubbico	Conf.	Box
CL80CBLS		220,04 €	192,54 €	1	12
CL80CBLD		220,04 €	192,54 €	1	12

## Sottolavelli 80x50 Bianco Lavello inox 80X50 1 vasche



Codice	Riferimenti	Prezzo	Off. Pubbico	Conf.	Box
CL80BDX		186,08 €	162,82 €	1	12

## Sottolavelli 80x50 TECK Lavello inox 80X50 1 vasche piu'



Codice	Riferimenti	Prezzo	Off. Pubbico	Conf.	Box
CL80TDX		186,08 €	162,82 €	1	12

## Sottolavelli 120x50 Bianco DX Lavello inox 120 X50



Codice	Riferimenti	Prezzo	Off. Pubbico	Conf.	Box
CL120BDX		238,64 €	208,81 €	1	12

## Sottolavelli 120x50 Teck DX Lavello inox 120 X50



Codice	Riferimenti	Prezzo	Off. Pubbico	Conf.	Box
CL120TDX		238,64 €	208,81 €	1	12

### SERIE PISA LAVELLO APPOGGIO

CODICE APELL	Misura	Indicazioni	Indicazioni	Indicazioni	Prezzo	Off. Pubbico	Conf.	Box
3740001C5	PI120RPC	destro	appoggio 50cm	prelucido	117,34 €	102,68 €	1	5
3740201C5	PI120LPC	sinistro	appoggio 50cm	prelucido	117,34 €	102,68 €	1	5



Categorie: **APPOGGIO, Pisa.**  
Etichette **Appoggio, Finitura Prelucida.**

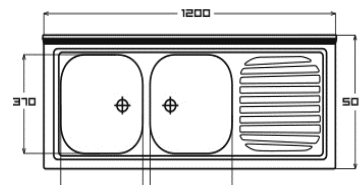

CODICE APELL	Codice	Prezzo	Off. Pubbico	Conf.	Box
3710001C5	PI801RPC	89,46 €	78,28 €	1	12
3710201C5	PI801LPC	89,46 €	78,28 €	1	12

CODICE APELL	Codice	Prezzo	Off. Pubbico	Conf.	Box
3750001C5	PI802PC	103,40 €	90,48 €	1	12

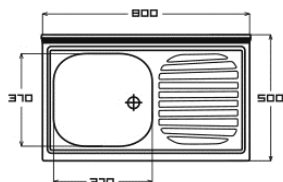

## LAVELLO INOX 86X50 SX ZZ

ht. 19  
hv. 17



### LAVELLO SALDATO SATINATO

Altezza Vasca HV 17 Altezza totale HT 19  
lavello import Turchia MoD. Sole

Codice	Riferimenti	Prezzo	Off. Pubbico	Conf.	Box
AI86501GSSX		63,25 €	55,35 €	1	12

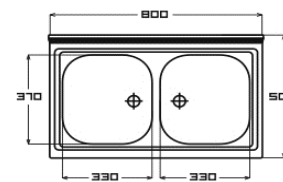

## LAVELLO INOX 86X50 DX ZZ

ht. 19  
hv. 17



### LAVELLO SALDATO SATINATO

Altezza Vasca HV 17 Altezza totale HT 19  
lavello import Turchia MoD. Sole

Codice	Riferimenti	Prezzo	Off. Pubbico	Conf.	Box
AI86501GSDX		63,25 €	55,35 €	1	12

TUTTI I MOBILI SONO REALIZZATI IN NOBILITATO SP.18MM.  
 - VASCHE IN GRANITO RESISTENTI AGLI ACIDI, DUREVOLI NEL TEMPO.

**LAVATOIO**



Codice	Misura	Prezzo	Off. Pubbico	Conf.	Box
EL70	70-50 H83	386,72 €	338,38 €	1	12
EL60	60-50 H83	365,95 €	320,21 €	1	12
EL50	50-50 H83	359,42 €	314,49 €	1	12

Mobile completo di vasca in granito colori a scelta

**COLORI VASCHE GRANITO DISPONIBILI**



BIANCO



SAND



NERO BRILLANTATO

**FINITURE DEI MOBILI DISPONIBILI**



BIANCO LUCIDO



ROVER SBIANCATO



FRASSINO MOIORE



ROVER WELL

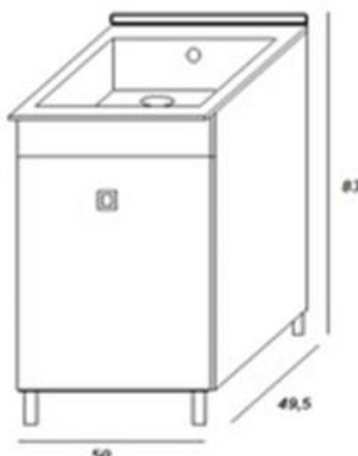



**GRANITEK**  
ESTETICA PIETRA NATURALE



**Gamma Completa**

G68 Bianco Titano  
cod. **LGF36068**

G62 Bianco Antico  
LGF36062

G61 Pietra Antica  
LGF36061

G59 Antracite  
LGF36059

G54 Nero  
LGF36054

G53 Terra  
LGF36053

G52 Bianco  
cod. **LGF36052**

G51 Avena  
LGF36051

G40 Full Black  
LGF36040



### Altri colori Richiedi il Prezzo

MASTER 500 1160X500 2 VASCHE  
C/GOCCIOLATOIO 51 AVENAZZ



**Prezzo**  
250,95 €  
**Pz** 10

**Codice** Riferimenti **Off. Pubbico**  
LGM50051 **GTK** 219,58 €

MASTER 400 860X500 MM 1 VASCA  
C/GOCCIOLATOIO 51 AVENA ZZ



**Prezzo**  
232,36 €  
**Pz** 3

**Codice** Riferimenti **Off. Pubbico**  
LGM40051 **GTK** 203,32 €

MASTER 450 860X500 MM 2 VASCHE 51  
AVENA ZZ



**Prezzo**  
237,01 €  
**Pz** 1

**Codice** Riferimenti **Off. Pubbico**  
LGM45051 **GTK** 207,39 €

LIFE 500 1160X500 2 VASCHEZZ CON  
GOCCIOLATOIO 51 AVENA



**Prezzo**  
232,36 €  
**Pz** 18

**Codice** Riferimenti **Off. Pubbico**  
LG250051 **GTK** 203,32 €

LIVING 400 860X500 1 VASCA CON  
GOCCIOLATOIO 51 AVENA



**Prezzo**  
193,57 €  
**Pz** 1

**Codice** Riferimenti **Off. Pubbico**  
LGL40051 **GTK** 169,37 €

LIFE 450 860X500 2 VASCHE ZZ 51 AVENA



**Prezzo**  
223,07 €  
**Pz** 0

**Codice** Riferimenti **Off. Pubbico**  
LG245051 **GTK** 195,19 €

FOX 360 860X500 MM 1 VASCA 51 AVENA ZZ



**Prezzo**  
264,90 €

**Codice** Riferimenti **Off. Pubbico**  
LGF36051 **GTK** 231,78 €

Lavello Laterale Monocomando  
Avena "Zc"

**Prezzo**



**Prezzo**  
45,54 €

**Codice** **Off. Pubbico**  
MXB005003AV 39,85 €

Mix Elleci S01 Avena 51



**Prezzo**  
92,35 €

**Codice** **Off. Pubbico**  
MGKS0151 80,81 €

Mix Elleci C01 Chrome



**Prezzo**  
89,82 €

**Codice** **Off. Pubbico**  
MIKC01CR 78,59 €

LAVELLO CRITERIA 900 C/KIT ZZCOLATOIO-TAGLIERE-  
DOS.SAP.-PIL ZZ



**EAPELL**



**Codice** **Riferimenti** **Prezzo** **Off. Pubbico** **Conf. Box**  
CRT860IKIT 292,78 € 256,18 € 1 12

VASCONE CRITERIA CR860 ZZ CR860IBC



**EAPELL**

860 x 500

**Codice** **Riferimenti** **Prezzo** **Off. Pubbico** **Conf. Box**  
CR860I 293,94 € 257,20 € 1 12

**KIT 4 PZ BOMPANI-APELL: LAVELLO CRITERIA COMPLETO DI ACCESSORI + FORNO 8 F. PIANO DA 75 G. GHISA+MIX CANNA ALTA ELLECCI**



LIMITED QUANTITIES AT THIS PRICE!

Codice	Descrizione	Prezzo	D.	Codice	Prezzo	Pz	Off. Pubbico	Costo tot.
CRT860IKIT	LAVELLO CRITERIA 900 C/KIT COLATOIO-TAC	292,78 €	7		1.224,99 €	2	€1.071,87	€2.143,73
BO2430H/E	Forno BO FLAT COMBI 8 FUNZ. "ZZ"	480,18 €	6	K4BF8P75MEC				
BO293MF/N	Piano 75 BO I 5FV(TC)ACS INOX FRONT 200:	362,21 €	12					
MIKC01CR	MIX ELLECCI C01 CHROME "ZC"	89,82 €	3					
					KIT 4 PZ BOMPANI-APELL: LAVELLO CRITERIA COMPLETO DI ACCESSORI + FORNO 8 F. PIANO DA 75 G. GHISA+MIX CANNA ALTA ELLECCI			
					€ 1.224,99			

**KIT 4 PZ BOMPANI-SOLE: LAVELLO SOLE + FORNO 6 F. PIANO DA 60 FRONTALE +MIX CANNA ALTA**



LIMITED QUANTITIES AT THIS PRICE!

Codice	Descrizione	Prezzo	D.	Codice	Prezzo	Pz	Off. Pubbico	Costo tot.
AI86501GSSX	Lavello inox 86X50 Sx	63,25 €	84		503,99 €	2	€ 440,99	€ 881,98
33703089	Forno Pop Evo Elettrico, Convection + Fan, €	255,25 €	0	K4S86BF6P60MCA				
33802764	Piano Cottura Gas Su MetalloGas, 4 Zone, In	155,74 €	6					
MLMDE00	Mix Debora Lav. Mon. C /Bassa	29,74 €	174					
					KIT 4 PZ BOMPANI-SOLE: LAVELLO SOLE + FORNO 6 F. PIANO DA 60 FRONTALE +MIX CANNA ALTA			
					€ 503,99			

**KIT 4 PZ BOMPANI-APELL: LAVELLO APELL 116 + FORNO BOMPANI 8 F.+PIANO DA 60 + MIX ELLECCI AVENA**



**CANDY**



CHW6BRAV4WGT



**ellecci**

Codice	Descrizione	Prezzo	D.	Codice	Prezzo	Pz	Off. Pubbico	Costo tot.
PTPL1162GO	Lavello 50.116 2V+G Gran.Avena	176,60 €	0		900,69 €	2	€ 788,11	€1.576,21
FCC604NAV	Fcc604Nav Forno Elettrico Da Incasso Ventil	388,09 €	5	K4BF8P75ACE				
CHW6BRAV4WGT	Piano Da 60Cm Avena; Griglie In Piattina; 4	243,66 €	1					
MGKC0151	Mix Ellecci C01 Avena 51	92,35 €	13					
					KIT 4 PZ BOMPANI-APELL: LAVELLO APELL 116 + FORNO BOMPANI 8 F.+PIANO DA 60 + MIX ELLECCI AVENA			
					€ 900,69			

**KIT 4 PZ SCHOCK-ELLECCI: LAVELLO MASTER + FORNO 5 F. PIANO DA 60 G. CANNA ALTA ELLECCI ESTRAIBILE**



Codice	Descrizione	Prezzo	D.	Codice	Prezzo	Pz	Off. Pubbico	Costo tot.
LGM50040	MASTER 500 1160X500 2 VASCHE C/GOCCIC	250,95 €	0		1.020,49 €	2	€ 892,93	€1.785,86
SFN54BKN	Forno NEW ENGLAND 5 FUNZ. NERO MAT "	453,11 €	14	K4SF5P60ECE				
STS64BK	Piano Cottura SILVER PC 60 BLACK "ZZ"	197,51 €	2					
MGKC0240	MIX C02 ELLECCI NERO 40 "ZC"	118,92 €	4					
					KIT 4 PZ SCHOCK-ELLECCI: LAVELLO MASTER + FORNO 5 F. PIANO DA 60 G. CANNA ALTA ELLECCI ESTRAIBILE			
					€ 1.020,49			

## Parete Combinabili Singole



vetro 6 mm

temperato

Codice	Riferimenti	Prezzo	Off. Pubbico	Conf.
PBS700218	68<>70 h. 190	113,86 €	99,63 €	1
PBS800218	78<>80 h. 190	118,92 €	104,05 €	1
PBS900218	88<>90 h. 190	121,45 €	106,27 €	1
PBS1000218	98<>100 h. 190	123,98 €	108,48 €	1
PBS1200218	118<>120 h. 190	129,04 €	112,91 €	1
PBS1400218	138<>140 h. 190	136,63 €	119,55 €	1

## Componi i lati secondo le tue necessità



Visualizza la gamma completa



## Porta Strass 118<>122 Sc.Le Vetro Trasparente Prof. Cromo

Codice	Misura	Prezzo
PS1200218	118<>122	240,37 €
PS1400218	138<>142	250,49 €

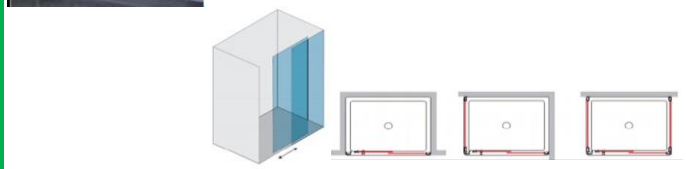

## Parete Fissa 68<>72 Prof. Cromo Vetro Trasparente

Codice	Misura	Prezzo
PF700218	68<>72	197,66 €
PF750218	73<>77	201,15 €
PF800218	78<>82	210,41 €

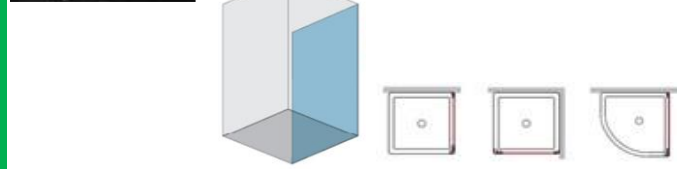

## Porta Doccia Strass 2 Ante 150 Vetro Satinato Prof. Cromo

Codice	Misura	Prezzo
PS2A1500218	148<>152	312,43 €
PS2A1600218	158<>162	325,18 €
PS2A1700218	168<>172	337,93 €
PS2A1800218	178<>182	364,35 €

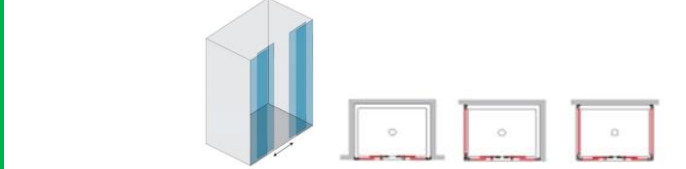

## Porta Doccia Strass 1 Anta 70 Vetro Satinato Prof. Cromo

Codice	Misura	Prezzo
PS1A700218	68<>72	191,28 €
PS1A750218	73<>77	197,66 €
PS1A800218	78<>82	204,03 €
PS1A900218	88<>92	213,60 €

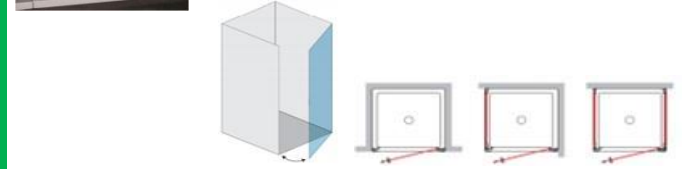

## Porta Doccia Book5 2 Ante 70 Vetro Temperato 5 Mm Trasparente

Codice	Misura	Prezzo
PB700218	68<>72	255,04 €
PB750218	73<>77	258,23 €
PB800218	78<>82	264,61 €
PB900218	88<>92	270,98 €
PB1000218	98<>102	280,55 €

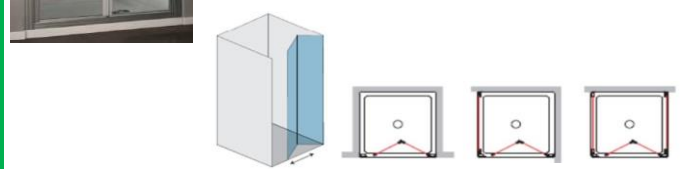

## Porta Doccia Strass 2 Ante 70 Vetro Trasparente prof. Cromo

Codice	Misura	Prezzo
PS2B700218	70 cm	191,28 €
PS2B750218	75 cm	200,85 €
PS2B800218	80 cm	209,50 €
PS2B900218	90 cm	220,43 €
PS2B1000218	100 cm	229,54 €

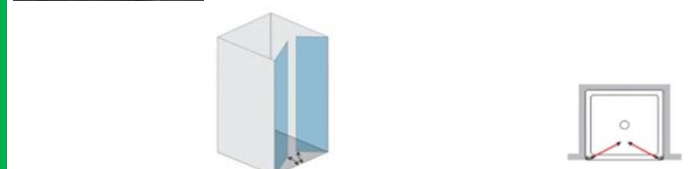





**Serie ANTARES**

Nuovi modelli prodotti in Pvc atossico, igienici e pratici per la pulizia, predisposti di binario con sistema di scorrimento laterale e con chiusura magnetica e attrezzati con sistema di scorrimento a pannelli lamellari anticondensa. Semplice da montare.

**MODELLI BOX DOCCIA IN PVC SERIE ANTARES**

Ariel/Antares PVC shower box - Ariel/Antares PVC shower box



**MODELLI BOX VASCA IN PVC SERIE ANTARES**

Ariel/Antares PVC shower for bath - Ariel/Antares PVC shower box for bath

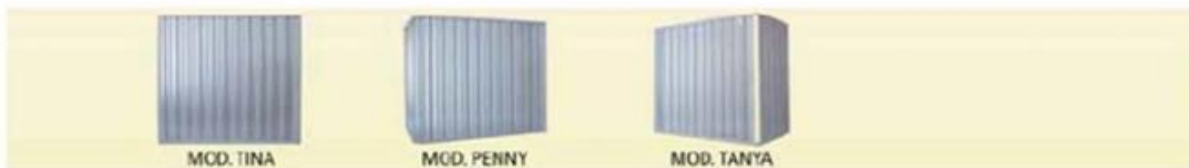

**BOX DOCCIA PVC SERIE "ANTARES" MOD. VERA**



Codice	Misura	Prezzo
BOXW70	70X70X70	148,11 €
BOXW80	80X80X80	156,50 €
BOXW90	90X90X90	165,05 €



**BOX DOCCIA PVC SERIE "ANTARES" MOD. MARY**



Codice	Misura	Prezzo
BOXQ70	70X70X70	120,23 €
BOXQ80	80X80X80	155,79 €
BOXQ90	90X90X90	181,55 €

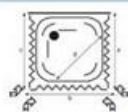

**BOX DOCCIA PVC SERIE "ANTARES" MOD. ANTHONY**



Codice	Misura	Prezzo
BOXU70	80 X 80	113,11 €
BOXU80	80 X 80	117,38 €
BOXU790	75 X 90	124,49 €
BOXU90	90 X 90	153,06 €
BOXU100	100 X 100	128,76 €

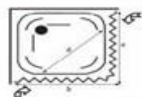

**BOX DOCCIA PVC SERIE "ANTARES" MOD. ANTHONY**



Codice	Misura	Prezzo
BOXS80	80 X 80	140,14 €
BOXS90	90 X 90	147,97 €
BOXX80	80X80 ap. Centr.	206,59 €
BOXX90	90X90 ap. Centr.	217,86 €

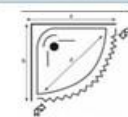

**BOX DOCCIA PVC SERIE "ANTARES" MOD. ELAN**



Codice	Misura	Prezzo
BOXE70	70	68,29 €
BOXE80	80	72,56 €
BOXE90	90	77,54 €
BOXE100	100	95,79 €
BOXE120	120	106,28 €
BOXE140	140	118,03 €
BOXE150	150	172,15 €
BOXE170	170	155,68 €

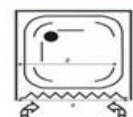

**BOX DOCCIA PVC SERIE "ANTARES" MOD. LILLY**



Codice	Misura	Prezzo
BOXZ70	70 X 70	110,34 €
BOXZ80	80 X 80	106,35 €
BOXZ790	75 X 90	102,44 €
BOXZ90	90 X 90	108,09 €
BOXZ100	100 X 100	118,09 €
BOXZ8120	80 X 120	168,46 €
BOXZ8140	80 X 140	182,49 €

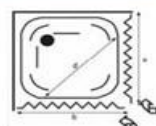

Vaso Civita Partete 360x480x405 mm in Ceramica Bianco Lucido



**PROMO**

**made in india**

Codice	Riferimenti	Prezzo	Off. Pubbico	Conf.
VSPPB	360x480x405	50,60 €	44,28 €	1
SAT1750	Copriwater\	34,08 €	29,82 €	1

Lavabo Civita in Ceramica Bianco Lucido



**PROMO**

**made in india**

Codice	Riferimenti	Prezzo	Off. Pubbico	Conf.
LUPB60	605x460x175	50,60 €	44,28 €	1
LUPB65	650x552x190	50,60 €	44,28 €	1

Vaso Civita Scarico Terra 360x475x400 mm in Ceramica Bianco Lucido



**PROMO**

**made in india**

Codice	Riferimenti	Prezzo	Off. Pubbico	Conf.
VSTPB	360x475x400	50,60 €	44,28 €	1
SAT1750	Copriwater	34,08 €	29,82 €	1

Colonna Civita 195x195x690 mm in Ceramica Bianco



**PROMO**

**made in india**

Codice	Riferimenti	Prezzo	Off. Pubbico	Conf.
CLUPB	195x195x690	50,60 €	44,28 €	1

Bidet Civita 365x525x400 mm in Ceramica Bianco Lucido



**PROMO**

**made in india**

Codice	Riferimenti	Prezzo	Off. Pubbico	Conf.
BUPB	365x525x400	50,60 €	44,28 €	1

Cassetta Alta Civita 435x250x325 mm in Ceramica Bianco



**PROMO**

**made in india**

Codice	Riferimenti	Prezzo	Off. Pubbico	Conf.
CAPB	435x250x325	37,95 €	33,21 €	1

Pila in Porcellana bianca 60X50X40



**PROMO**

**made in india**

Codice	Riferimenti	Prezzo	Off. Pubbico	Conf.
AS03	60X50X40	126,51 €	110,70 €	1

Buttaioio in Porcellana Bianca 380x470x250



**PROMO**

**made in india**

Codice	Riferimenti	Prezzo	Off. Pubbico	Conf.
AS01	380x470x250	88,56 €	77,49 €	1

Serie Jubilaeum

**AZZURRA**  
riscopri la purezza



Articoli in Esaurimento

Serie Jubilaeum



Codice	Riferimenti	Prezzo	Off. Pubbico	Conf.
JUVCTP000000	Vaso	202,42 €	177,11 €	1
JUBITOB0000M	Bidet	202,42 €	177,11 €	1

Codice	Riferimenti	Prezzo	Off. Pubbico	Conf.
GLZ100P	Vaso	166,94 €	146,07 €	1
GLZ500B4	Bidet	166,93 €	146,06 €	1

Serie fast



Codice	Riferimenti	Prezzo	Off. Pubbico	Conf.
FABITM	Vaso	97,59 €	85,39 €	1
FAVCTP	Bidet	97,59 €	85,39 €	1

Serie Cult

**AZZURRA**  
riscopri la purezza



Codice	Riferimenti	Prezzo	Off. Pubbico	Conf.
CLZ100B4P	Vaso	102,02 €	89,27 €	1
CLZ500B4	Bidet	102,02 €	89,27 €	1

Guardate in piattaforma per residui sanitari e mobili bagno

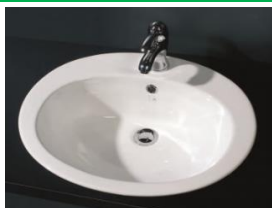

Lavabo Soprapiano

Codice	Riferimenti	Prezzo	Off. Pubbico	Conf.
TATZASW		138,45 €	121,15 €	1



Vaso Scarico Terra S/Europa

Codice	Riferimenti	Prezzo	Off. Pubbico	Conf.
CNVW3200S	Vaso	65,22 €	57,07 €	1

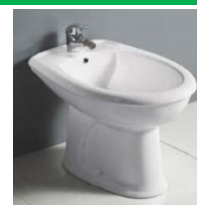

Bidet S/Europa

Codice	Riferimenti	Prezzo	Off. Pubbico	Conf.
CNVBD3200	bidet	54,84 €	47,98 €	1



Lavabo Corinto Cm 48X27 S/Foro

Codice	Riferimenti	Prezzo	Off. Pubbico	Conf.
AVB4		50,10 €	43,84 €	1



Labavo Corinto Cm. 58X45

Codice	Riferimenti	Prezzo	Off. Pubbico	Conf.
AVB6		50,10 €	43,84 €	1



Lavabo Sottopiano Largo 580 Profondo 360 " Zz"

Codice	Riferimenti	Prezzo	Off. Pubbico	Conf.
TATZAVW		115,68 €	101,22 €	1



## Piatto doccia EASY STONE

Piatto doccia rettangolare completa di piletta sifonata 90x120.

Effetto Pietra. Sp. 2,5 cm.

Colore Bianco

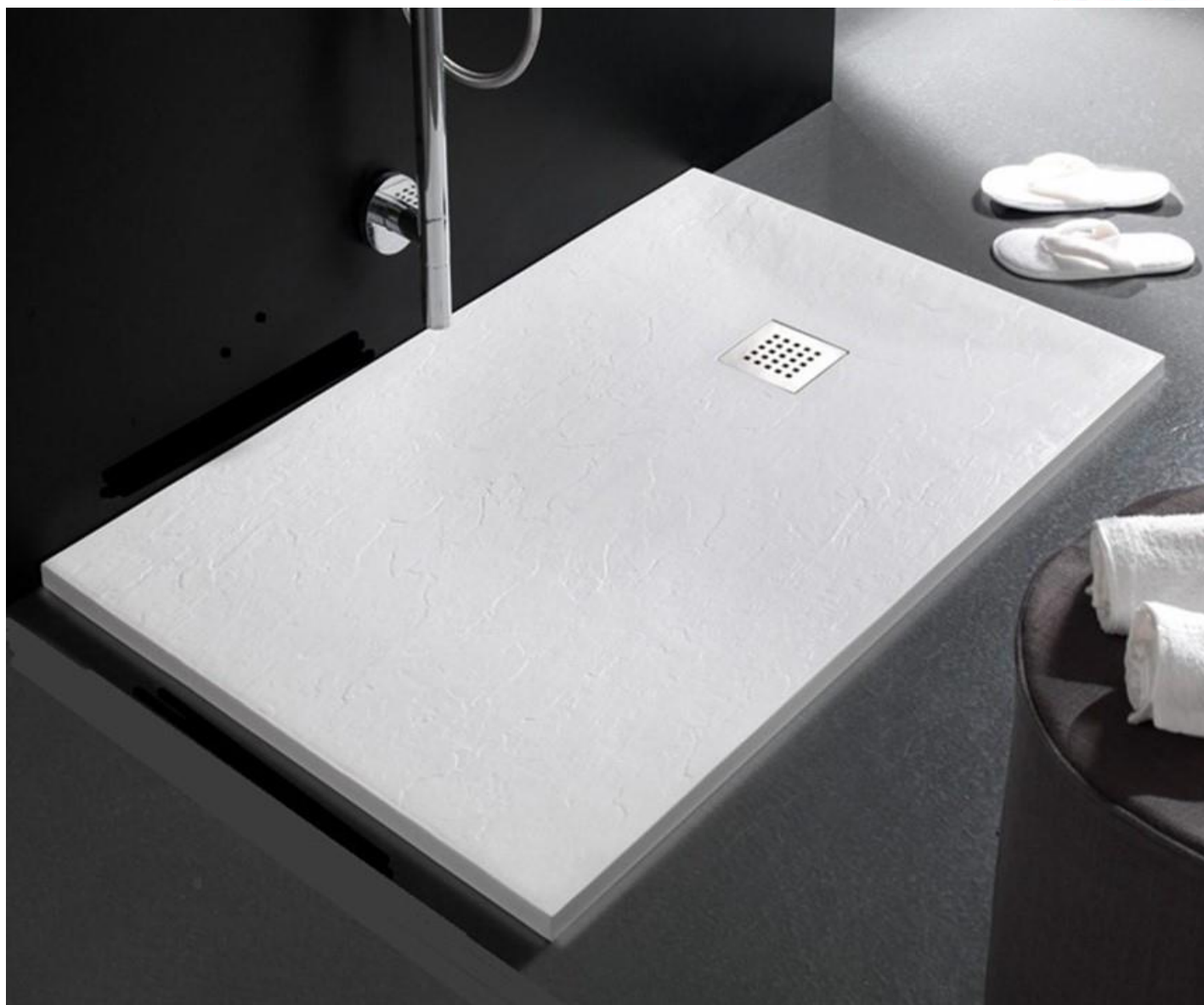
**PROMO**

Codice Csr	Codice	Colore	Misura	Descrizione	Prezzo	Off. Pubblico
720090070		Bianco	70x90 cm	Piatto doccia EASY STONE	249,40 €	218,23 €
720100070		Bianco	70x100 cm	Piatto doccia EASY STONE	268,41 €	234,86 €
720120070		Bianco	70x120 cm	Piatto doccia EASY STONE	315,91 €	276,42 €
720140070		Bianco	70x140 cm	Piatto doccia EASY STONE	363,42 €	317,99 €
720160070		Bianco	70x160 cm	Piatto doccia EASY STONE	361,95 €	316,70 €
720170070		Bianco	70x170 cm	Piatto doccia EASY STONE	415,67 €	363,71 €
720100080		Bianco	80x100 cm	Piatto doccia EASY STONE	327,79 €	286,82 €
720120080		Bianco	80x120 cm	Piatto doccia EASY STONE	356,29 €	311,76 €
720140080		Bianco	80x140 cm	Piatto doccia EASY STONE	403,80 €	353,32 €
720160080		Bianco	80x160 cm	Piatto doccia EASY STONE	395,88 €	346,40 €
720170080		Bianco	80x170 cm	Piatto doccia EASY STONE	446,14 €	390,37 €

**AIRGAMA**

*Componenti interne / Inner parts*

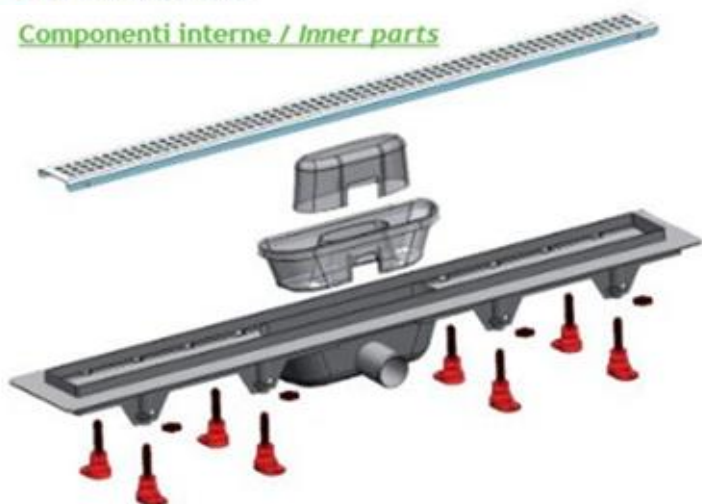

*Imballo singolo  
1 Channel per box*



*Design ricercato / Innovative design*



*Sifone interno / inner siphon*



*Guaina impermeabilizzante / Waterproof tape*



*Piedini regolabili / Adjustable height*



Codice	Descrizione	D.	L	H	Prezzo	Off. Pubbico
CDG390NX40	griglia	40	390	66	164,53 €	143,97 €
CDG650NX40	griglia	40	650	66	181,43 €	158,75 €
CDG75SNX4050	griglia	40	750	66	156,57 €	137,00 €
CDG85SNX4050	griglia	40	850	66	167,75 €	146,78 €
CDP390NX40	piana	40	390	66	135,18 €	118,29 €
CDP650NX40	piana	40	650	66	126,38 €	110,58 €
CDP75VNX4050	piana	40	750	66	167,75 €	146,78 €
CDP85VNX4050	piana	40	850	66	180,66 €	158,07 €

## Legenda Sintesi Raccordi Polietilene ottone

Codice	Descrizione	Ø	Codice	Descrizione	Codice	Descrizione	Codice	Descrizione	Codice	Descrizione
NM20PB	Nipples Maschio	20	NF20PB	Nipples Femmina	GF20PB	Gomito Femmina	T20PB	Tee 3 lati	TF20PB	Tee f. 1/2"X20
NM25PB	Nipples Maschio	25	NF25PB	Nipples Femmina	GF25PB	Gomito Femmina	T25PB	Tee 3 lati	TF25PB	Tee f. 3/4"X25
NM32PB	Nipples Maschio	32	NF32PB	Nipples Femmina	GF32PB	Gomito Femmina	T32PB	Tee 3 lati	TF32PB	Tee f. 1"X32
NM40PB	Nipples Maschio	40	NF40PB	Nipples Femmina	GF40PB	Gomito Femmina	T40PB	Tee 3 lati	TF40PB	Tee f. 1 1/4"X40
NM50PB	Nipples Maschio	50	NF50PB	Nipples Femmina	GF50PB	Gomito Femmina	T50PB	Tee 3 lati	TF50PB	Tee f. 1 1/2"X50
NM63PB	Nipples Maschio	63	NF63PB	Nipples Femmina	GF63PB	Gomito Femmina	T63PB	Tee 3 lati	TF63PB	Tee f. 2"X63

## Legenda Sintesi Raccordi Polietilene Plastica

D.	C.	Ø	Codice	Descrizione	Codice Finale	Codice	Descrizione	Codice Finale	Codice	Descrizione	Codice Finale	Codice	Codice Finale
1/2"	D	20	330-	Nipplo Maschio	330-D20	330A-	Nipplo Femmina	330A-D20	331-	Nipplo Doppio	331-20	332-	332-20
3/4"	G	25	330-	Nipplo Maschio	330-G25	330A-	Nipplo Femmina	330A-G25	331-	Nipplo Doppio	331-25	332-	332-25
1"	H	32	330-	Nipplo Maschio	330-H32	330A-	Nipplo Femmina	330A-H32	331-	Nipplo Doppio	331-32	332-	332-32
1 1/4"	HB	40	330-	Nipplo Maschio	330-HB40	330A-	Nipplo Femmina	330A-HB40	331-	Nipplo Doppio	331-40	332-	332-40
1 1/2"	HD	50	330-	Nipplo Maschio	330-HD50	330A-	Nipplo Femmina	330A-HD50	331-	Nipplo Doppio	331-50	332-	332-50
2"	OL	63	330-	Nipplo Maschio	330-OL63	330A-	Nipplo Femmina	330A-OL63	331-	Nipplo Doppio	331-63	332-	332-63
2 1/2"	OLD	75	330-	Nipplo Maschio	330-OLD75	330A-	Nipplo Femmina	330A-OLD75	331-	Nipplo Doppio	331-75	332-	332-75
3"	Y	90	330-	Nipplo Maschio	330-Y90	330A-	Nipplo Femmina	330A-Y90	331-	Nipplo Doppio	331-90	332-	332-90
4"	Z	110	330-	Nipplo Maschio	330-Z110	330A-	Nipplo Femmina	330A-Z110	331-	Nipplo Doppio	331-110	332-	332-110

Legenda Sintesi Raccordi Ottone Giallo Lettera indicativa "G"; Per i Raccordi Cromati la lettera indicativa sarà "C"; Per la raccorderia Zincata la lettera indicativa sarà "Z"; Sul foglio ordine attenzionare lo slesc nel codice articolo \ e non /

Codice	Descrizione	Ø	Codice	Descrizione	Codice	Descrizione	Codice	Descrizione	Codice	Descrizione
GZ3\8	Gomito Zincato FF	3/8"	GZ3\8MF	Gomito Zincato FF	TZ3\8	Tee ZINCATO FFF	NZ3\8	NIPLES ZINCATO	MZ3\8	MAMICOTTO ZINCATO
GZ1\2	Gomito Zincato FF	1/2"	GZ1\2MF	Gomito Zincato FF	TZ1\2	Tee ZINCATO FFF	NZ1\2	NIPLES ZINCATO	MZ1\2	MAMICOTTO ZINCATO
GZ3\4	Gomito Zincato FF	3/4"	GZ3\4MF	Gomito Zincato FF	TZ3\4	Tee ZINCATO FFF	NZ3\4	NIPLES ZINCATO	MZ3\4	MAMICOTTO ZINCATO
GZ1	Gomito Zincato FF	1"	GZ1MF	Gomito Zincato FF	TZ1	Tee ZINCATO FFF	NZ1	NIPLES ZINCATO	MZ1	MAMICOTTO ZINCATO
GZ11\4	Gomito Zincato FF	1 1/4"	GZ11\4MF	Gomito Zincato FF	TZ11\4	Tee ZINCATO FFF	NZ11\4	NIPLES ZINCATO	MZ11\4	MAMICOTTO ZINCATO
GZ11\2	Gomito Zincato FF	1 1/2"	GZ11\2MF	Gomito Zincato FF	TZ11\2	Tee ZINCATO FFF	NZ11\2	NIPLES ZINCATO	MZ11\2	MAMICOTTO ZINCATO
GZ2	Gomito Zincato FF	2"	GZ2MF	Gomito Zincato FF	TZ2	Tee ZINCATO FFF	NZ2	NIPLES ZINCATO	MZ2	MAMICOTTO ZINCATO
GZ2\1\2	Gomito Zincato FF	2 1/2"	GZ2\1\2MF	Gomito Zincato FF	TZ3	Tee ZINCATO FFF	NZ3	NIPLES ZINCATO	MZ3	MAMICOTTO ZINCATO
GZ3	Gomito Zincato FF	3"	GZ3MF	Gomito Zincato FF	TZ4	Tee ZINCATO FFF	NZ4	NIPLES ZINCATO	MZ4	MAMICOTTO ZINCATO
GZ4	Gomito Zincato FF	4"	GZ4MF	Gomito Zincato FF	TZ5	Tee ZINCATO FFF	NZ5	NIPLES ZINCATO	MZ5	MAMICOTTO ZINCATO

## Legenda Colori Guarnizioni

D.	C.	Codice	Descrizione	Codice Finale
1/4"	B	2100ESE	Guarnizione Esente	2100ESE0B
3/8"	C	2100ESE	Guarnizione Esente	2100ESE0C
1/2"	D	2100ESE	Guarnizione Esente	2100ESE0D
3/4"	G	2100ESE	Guarnizione Esente	2100ESE0G
1"	H	2100ESE	Guarnizione Esente	2100ESE0H
1 1/4"	HB	2100ESE	Guarnizione Esente	2100ESEHB
1 1/2"	HD	2100ESE	Guarnizione Esente	2100ESEHD
2"	OL	2100ESE	Guarnizione Esente	2100ESEOL
2 1/2"	OLD	2100ESE	Guarnizione Esente	2100ESEOLD
3"	OY	2100ESE	Guarnizione Esente	2100ESE0Y
4"	OZ	2100ESE	Guarnizione Esente	2100ESE0Z

## Legenda Raccordi e Tubi Pvc

D.	C.	Descrizione	Codice Finale	C.	Descrizione	Codice Finale
32	CC	Curva Chiusa	CC32	CA	Curva Aperta	CA32
40	CC	Curva Chiusa	CC40	CA	Curva Aperta	CA40
50	CC	Curva Chiusa	CC50	CA	Curva Aperta	CA50
63	CC	Curva Chiusa	CC63	CA	Curva Aperta	CA63
80	CC	Curva Chiusa	CC80	CA	Curva Aperta	CA80
100	CC	Curva Chiusa	CC100	CA	Curva Aperta	CA100
125	CC	Curva Chiusa	CC125	CA	Curva Aperta	CA125
140	CC	Curva Chiusa	CC140	CA	Curva Aperta	CA140
160	CC	Curva Chiusa	CC160	CA	Curva Aperta	CA160
200	CC	Curva Chiusa	CC200	CA	Curva Aperta	CA200

## Legenda Colori Rubinetti

I.	Colore	I.	Colore
00	Cromato	80	Granito Bianco
04	Bianco	81	Granito Nero
		82	Granito Rosa
		83	Granito Pietro
		84	Granito Grigio
		85	Granito Avena
47	Bronzato		
65	Rame		
100	Terra Francia		

D.	C.	Descrizione	Codice Finale	C.	Descrizione	Codice Finale
32	BV	Braga a V	BV32	BT	Braga a T	BT32
40	BV	Braga a V	BV40	BT	Braga a T	BT40
50	BV	Braga a V	BV50	BT	Braga a T	BT50
63	BV	Braga a V	BV63	BT	Braga a T	BT63
80	BV	Braga a V	BV80	BT	Braga a T	BT80
100	BV	Braga a V	BV100	BT	Braga a T	BT100
125	BV	Braga a V	BV125	BT	Braga a T	BT125
140	BV	Braga a V	BV140	BT	Braga a T	BT140
160	BV	Braga a V	BV160	BT	Braga a T	BT160
200	BV	Braga a V	BV200	BT	Braga a T	BT200



**PROFESSIONALITA' E QUALITA'****EVOKlima**™

TECNOLOGIA - BENESSERE - RISPETTO PER L'AMBIENTE

**WWW.EVOKLIMA.IT**

PRESENTE NELLA PIATTAFORMA

[www.edrcsr.it](http://www.edrcsr.it)**TUTTO PER LA CASA DALLA A ALLA Z****LA PIATTAFORMA  
RIVOLTA  
AI RIVENDITORI  
E PROFESSIONISTI DEL SETTORE****Gruppo C. S. R. s. r. l. unipersonale****Deposito Zona Industriale Asi contrada San Benedetto Aragona (AG)****Email: [edrcsr@gmail.com](mailto:edrcsr@gmail.com) [Info@evoklima.it](mailto:Info@evoklima.it) Tel. 09221801565**

Responsabile magazzino agrigento Alessio Conti+39 328 202 6997