



Curva Aperta 45° (storta)



Codice	SubCodice	Riferimenti	Listino	U.M.	Conf.
CA32	8000100118720	D. 32	€ 0,44	1	10
CA40	0	D. 40	€ 0,53	1	10
CA50	0	D. 50	€ 0,80	1	10
CA63	0	D. 63	€ 1,25	1	10
CA80	0	D. 80	€ 1,51	1	10
CA100	8000100118775	D. 100	€ 1,69	1	10
CA125	8000100118768	D. 125	€ 2,67	1	10
CA140	8000100118751	D. 140	€ 4,00	1	10
CA160	8000100118744	D. 160	€ 5,34	1	10
CA200	8000100118737	D. 200	€ 8,89	1	10

Curva Chiusa 87° (gomito)



Codice	SubCodice	Riferimenti	Listino	U.M.	Conf.
CC32	8000100118843	D. 32	€ 0,53	1	10
CC40	8000100118829	D. 40	€ 0,62	1	10
CC50	8000100118805	D. 50	€ 0,89	1	10
CC63	8000100118799	D. 63	€ 1,33	1	10
CC80	8000100118782	D. 80	€ 1,69	1	10
CC100	8000100118898	D. 100	€ 1,96	1	10
CC125	8000100118881	D. 125	€ 3,11	1	10
CC140	8000100118874	D. 140	€ 4,89	1	10
CC160	8000100118867	D. 160	€ 5,78	1	10
CC200	8000100118850	D. 200	€ 10,67	1	10

Derivazione (braga) "V" 45°



Codice	SubCodice	Riferimenti	Listino	U.M.	Conf.
BV32	8000100117839	D. 32	€ 0,80	1	10
BV40	8000100118232	D. 40	€ 0,89	1	10
BV50	8000100118225	D. 50	€ 1,16	1	10
BV63	8000100118218	D. 63	€ 2,22	1	10
BV80	8000100118201	D. 80	€ 3,20	1	10
BV100	8000100117891	D. 100	€ 3,56	1	10
BV125	8000100117884	D. 125	€ 6,23	1	10
BV140	8000100117877	D. 140	€ 8,45	1	10
BV160	8000100117860	D. 160	€ 10,67	1	10
BV200	8000100117853	D. 200	€ 21,34	1	10

Derivazione (braga) "T" 90°



Codice	SubCodice	Riferimenti	Listino	U.M.	Conf.
BT32	8000100117471	D. 32	€ 0,80	1	10
BT40	8000100117464	D. 40	€ 0,89	1	10
BT50	8000100117457	D. 50	€ 1,16	1	10
BT63	8000100117444	D. 63	€ 2,22	1	10
BT80	8000100117433	D. 80	€ 3,20	1	10
BT100	8000100117525	D. 100	€ 3,56	1	10
BT125	8000100117518	D. 125	€ 6,23	1	10
BT140	8000100117501	D. 140	€ 8,45	1	10
BT160	8000100117495	D. 160	€ 10,67	1	10
BT200	8000100117488	D. 200	€ 21,34	1	10

Derivazione Ridotta (braga ridotta) "V" 45°



Codice	SubCodice	Riferimenti	Listino	U.M.	Conf.
BVR100X40	8000100118195	100x40	€ 3,11	1	10
BVR100X50	8000100118171	100X50	€ 3,11	1	10
BVR100X63	8000100118157	100X63	€ 3,11	1	10
BVR100X80	8000100118140	100X80	€ 3,11	1	10
BVR125X40	8000100118126	125X40	€ 7,11	1	10
BVR125X50	8000100118119	125X50	€ 7,11	1	10
BVR125X63	8000100118102	125X63	€ 7,11	1	10
BVR125X80	8000100118096	125X80	€ 7,11	1	10
BVR125X100	8000100118133	125X100	€ 7,11	1	10



Derivazione Ridotta (braga ridotta) "T" 90°

Codice	SubCodice	Riferimenti	Listino	U.M.	Conf.
BVR100X40		100x40	Richiedere	1	10
BVR100X50		100X50	Richiedere	1	10
BVR100X63		100X63	Richiedere	1	10
BVR100X80		100X80	Richiedere	1	10
BVR125X40		125X40	Richiedere	1	10
BVR125X50		125X50	Richiedere	1	10
BVR125X63		125X63	Richiedere	1	10
BVR125X80		125X80	Richiedere	1	10
BVR125X100		125X100	Richiedere	1	10



Riduzione Bicchiere Sul Maggiore

Codice	SubCodice	Riferimenti	Listino	U.M.	Conf.
R40X32		40Fx32M	Richiedere	1	10
R50X40		50Fx40M	Richiedere	1	10
R63X40		63Fx40M	Richiedere	1	10
R80X63		80Fx63M	Richiedere	1	10
R80X40		80Fx40M	Richiedere	1	10
R100X80		100Fx80M	Richiedere	1	10
R100X63		100Fx63M	Richiedere	1	10
R100X40		100Fx40M	Richiedere	1	10
R125X100		125Fx100M	Richiedere	1	10
R140X100		140Fx100M	Richiedere	1	10
R140X125		140Fx125M	Richiedere	1	10
R160X140		160Fx140M	Richiedere	1	10
R200X160		200Fx160M	Richiedere	1	10



Aumento Bicchiere Sul Minore

Codice	SubCodice	Riferimenti	Listino	U.M.	Conf.
A32X40		40Mx32F	Richiedere	1	10
A40X50		50Mx40F	Richiedere	1	10
A40X63		63Mx40F	Richiedere	1	10
A40X80		80Mx40F	Richiedere	1	10
A40X100		100Mx40F	Richiedere	1	10
A63X80		80Mx63F	Richiedere	1	10
A63X100		100Mx63F	Richiedere	1	10
A80X100		100Mx80F	Richiedere	1	10
A100X125		125Mx100F	Richiedere	1	10
A100X140		140Mx100F	Richiedere	1	10
A125X140		140Mx125F	Richiedere	1	10
A140X160		160Mx140F	Richiedere	1	10
A160X200		200Mx160F	Richiedere	1	10



Tampone aumento Bicchere Minore

Codice	SubCodice	Riferimenti	Listino	U.M.	Conf.
T40X32		40x32	Richiedere	1	10
T63X40		63x40	Richiedere	1	10
T80X40		80x40	Richiedere	1	10
T100X40		100x40	Richiedere	1	10
T125X100		125x100	Richiedere	1	10
T125X40		125x40	Richiedere	1	10
T100X32X3		100x32x32	Richiedere	1	10
T100X40X3		100x40x32	Richiedere	1	10
T100X40X4		100x40x40	Richiedere	1	10

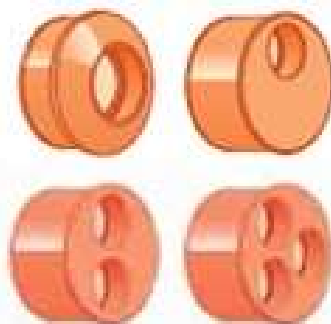

Tampone a tre fori da 40

Codice	SubCodice	Riferimenti	Listino	U.M.	Conf.
TA100TF40		100-40-40-40	Richiedere	1	10





ISPEZIONABILE

SIFONE O-O DA 100 "ZC"

Codice	SubCodice	Riferimenti	Listino	U.M.	Conf.
SOO100240	Richiedere	2 usc. 40 predisposti	Richiedere	1	10



SIFONE O-O DA 100 "ZC"

Codice	SubCodice	Riferimenti	Listino	U.M.	Conf.
SOO100	0		€ 13,34	1	10
SOO125	0		€ 17,79	1	10



SIFONE V-O DA 100 "ZC"

Codice	SubCodice	Riferimenti	Listino	U.M.	Conf.
SVO100	0		€ 17,79	1	10
SVO125	0		€ 22,23	1	10



SIFONE ROMA DA 100 PVC "ZC"

Codice	SubCodice	Riferimenti	Listino	U.M.	Conf.
SR100	0		€ 27,57	1	10
SR80	0		€ 27,21	1	10



SIFONE VV DA 100 MONOLOITICO "ZC"

Codice	SubCodice	Riferimenti	Listino	U.M.	Conf.
SVV100	0		€ 23,12	1	10



SIFONE VERTICALE MARTINO 80 "ZC"

Codice	SubCodice	Riferimenti	Listino	U.M.	Conf.
SVM80	0		€ 18,72	1	10
SVM100	0		€ 22,72	1	10



BOCCHETTONE ANGOLO 100 PVC "ZC"

Codice	SubCodice	Riferimenti	Listino	U.M.	Conf.
BPA100	0	angolo 100	€ 8,82	1	10
BP100	0	pavimento 100	€ 8,82	1	10

Nota bene i pezzi speciali possono essere lavorati artigianalmente con saldature professionali

GIUNTO SCORREVOLE DA 80 "ZC"

Codice	SubCodice	Riferimenti	Listino	U.M.	Conf.
GS80	0	D. 80	€ 6,23	1	10
GS100	0	D. 100	€ 7,11	1	10
GS125	0	D. 125	€ 10,67	1	10



GIUNTO RIPARAZIONE DA 100 "ZC"

Codice	SubCodice	Riferimenti	Listino	U.M.	Conf.
GR100	0	D. 100	€ 7,11	1	10
GR125	0	D. 125	€ 10,67	1	10



Tappo a Vite

Codice	SubCodice	Riferimenti	Listino	U.M.	Conf.
TV32	0	D. 32	€ 2,54	1	10
TV40	0	D. 40	€ 0,81	1	10
TV50	0	D. 50	€ 1,60	1	10
TV63	0	D. 63	€ 2,04	1	10
TV80	0	D. 80	€ 2,22	1	10
TV100	0	D. 100	€ 2,67	1	10
TV125	0	D. 125	€ 3,56	1	10
TV140	0	D. 140	€ 5,78	1	10
TV160	0	D. 160	€ 7,74	1	10
TV200	0	D. 200	€ 10,22	1	10



Tappo Fisso

Codice	SubCodice	Riferimenti	Listino	U.M.	Conf.
TFS32	0	D. 32	€ 0,56	1	10
TFS40	0	D. 40	€ 0,27	1	10
TFS50	0	D. 50	€ 0,36	1	10



Valvola Antiriflusso

Codice	SubCodice	Riferimenti	Listino	U.M.	Conf.
VA100	0	D. 100	€ 66,70	1	10
VA125	0	D. 125	€ 75,60	1	10
VA140	0	D. 140	€ 80,04	1	10
VA160	0	D. 160	€ 124,51	1	10
VA200	0	D. 200	€ 142,30	1	10



Scorrevole con fermo Cod. MFS

Codice	SubCodice	Riferimenti	Listino	U.M.	Conf.
MFS32	0		€ 1,60	1	10
MFS40	0		€ 3,56	1	10



Scorrevole senza fermo Cod. MFS

Codice	SubCodice	Riferimenti	Listino	U.M.	Conf.
MS80	0	D. 80	€ 4,09	1	10
MS100	0	D. 100	€ 4,45	1	10
MS125	0	D. 125	€ 5,34	1	10



Curva 90° con ispezione in Testa

Codice	SubCodice	Riferimenti	Listino	U.M.	Conf.
CSTV87100	0	D. 100	€ 7,29	1	10



Nota bene i pezzi speciali possono essere lavorati artigianalmente con saldature professionali

CSTVS



Curva 90° con ispezione SX

Codice	SubCodice	Riferimenti	Listino	U.M.	Conf.
CSTVS87100	0	D. 100	€ 12,37	1	10
CSTVS87125	0	D. 125	€ 13,24	1	10
CSTVS87140	Richiedere	D. 140	Richiedere	1	10
CSTVS87160	0	D. 160	€ 20,14	1	10
CSTVS87200	Richiedere	D. 200	Richiedere	1	10

CSTVD



Curva 90° con ispezione DX

Codice	SubCodice	Riferimenti	Listino	U.M.	Conf.
CSTVD87100	0	D. 100	€ 7,29	1	10
CSTVD87125	0	D. 125	€ 13,24	1	10
CSTVD87140	Richiedere	D. 140	Richiedere	1	10
CSTVD87160	0	D. 160	€ 20,14	1	10
CSTVD87200	Richiedere	D. 200	Richiedere	1	10

CSTVD



Curva 45° con ispezione DX

Codice	SubCodice	Riferimenti	Listino	U.M.	Conf.
CSTVD45100	0	D. 100	€ 6,38	1	10
CSTVD45125	0	D. 125	€ 13,24	1	10
CSTVD45140	Richiedere	D. 140	Richiedere	1	10
CSTVD45160	0	D. 160	€ 20,14	1	10
CSTVD45200	Richiedere	D. 200	Richiedere	1	10

CSTVS



Curva 45° con ispezione SX

Codice	SubCodice	Riferimenti	Listino	U.M.	Conf.
CSTVS45100	0	D. 100	€ 12,37	1	10
CSTVS45125	0	D. 125	€ 13,24	1	10
CSTVS45140	Richiedere	D. 140	Richiedere	1	10
CSTVS45160	0	D. 160	€ 20,14	1	10
CSTVS45200	Richiedere	D. 200	Richiedere	1	10

DSTVD



Derivazione V 45° Con ispezione DX

Codice	SubCodice	Riferimenti	Listino	U.M.	Conf.
DSTVD45100	8000100117938	D. 100	€ 10,48	1	10
DSTVD45125	8000100117921	D. 125	€ 20,56	1	10

DSTVS



Derivazione V 45° Con ispezione SX

Codice	SubCodice	Riferimenti	Listino	U.M.	Conf.
DSTVS45100	8000100117914	D. 100	€ 17,38	1	10
DSTVS45125	8000100117907	D. 125	€ 20,88	1	10

DSTVS



Derivazione T 87° 30' Con ispezione DX

Codice	SubCodice	Riferimenti	Listino	U.M.	Conf.
DSTVS87100	0	D. 100	€ 17,38	1	10
DSTVS87125	0	D. 125	€ 20,88	1	10

DSTVD



Derivazione T 87° 30' Con ispezione SX

Codice	SubCodice	Riferimenti	Listino	U.M.	Conf.
DSTVD87100	0	D. 100	€ 10,48	1	10
DSTVD87125	0	D. 125	€ 20,88	1	10



Derivazione T 87° 30' Con tappo ispezione

Codice	SubCodice	Riferimenti	Listino	U.M.	Conf.
DTIS100	0	D. 100	€ 5,69	1	10



Braga doppia a Croce

Codice	SubCodice	Riferimenti	Listino	U.M.	Conf.
BC100	8000100118287	D. 100	€ 6,24	1	10



Braga doppia ad angolo 45°

Codice	SubCodice	Riferimenti	Listino	U.M.	Conf.
BVD100	8000100118256	D. 100	€ 10,67	1	10
BVD125	8000100118249	D. 125	€ 16,01	1	10



Braga doppia scagno ad angolo 45°

Codice	SubCodice	Riferimenti	Listino	U.M.	Conf.
BVS100	8000100118270	D. 100	€ 18,31	1	10
BVS125	8000100118263	D. 125	€ 27,33	1	10



Braga a "V" ridotta 45°

Codice	SubCodice	Riferimenti	Listino	U.M.	Conf.
BVR100X40	8000100118195	100x40	€ 3,11	1	10
BVR100X50	8000100118171	100X50	€ 3,11	1	10
BVR100X63	8000100118157	100X63	€ 3,11	1	10
BVR100X80	8000100118140	100X80	€ 3,11	1	10



Derivazione ridotta 45° doppia lineare

Codice	SubCodice	Riferimenti	Listino	U.M.	Conf.
BVR40X100X40	8000100118089	40x100x40	€ 7,56	1	10



Derivazione ridotta 45° doppia stesso lato

Codice	SubCodice	Riferimenti	Listino	U.M.	Conf.
DR2V10040	8000100118034	100x40x40	€ 5,13	1	10



Derivazione ridotta 45° tripla 1+2 lineare

Codice	SubCodice	Riferimenti	Listino	U.M.	Conf.
DR3V10040	8000100118010	40X100x40X40	€ 9,17	1	10



Derivazione ridotta 45° Poker 2+2 lineare

Codice	SubCodice	Riferimenti	Listino	U.M.	Conf.
DR4V10040	8000100118003	40X40X100x40X40	€ 10,48	1	10



Nota bene i pezzi speciali possono essere lavorati artigianalmente con saldature professionali



Derivazione Ridotta (braga ridotta) "T" 90°

Codice	SubCodice	Riferimenti	Listino	U.M.	Conf.
BVR100X40	8000100118195	100x40	Richiedere	1	10
BVR100X50	8000100118171	100X50	Richiedere	1	10
BVR100X63	8000100118157	100X63	Richiedere	1	10



Derivazione ridotta 87° doppia stesso lato

Codice	SubCodice	Riferimenti	Listino	U.M.	Conf.
DR2T10040	8000100117723	100x40X40	Richiedere	1	10



Derivazione ridotta 87° tripla stesso lato

Codice	SubCodice	Riferimenti	Listino	U.M.	Conf.
DR3T10040	8000100117709	100x40X40x40	Richiedere	1	10



Derivazione ridotta 87° poker stesso lato

Codice	SubCodice	Riferimenti	Listino	U.M.	Conf.
DR4T10040	8000100117693	100x40X40x40x40	Richiedere	1	10



Derivazione ridotta 87° doppia ad angolo

Codice	SubCodice	Riferimenti	Listino	U.M.	Conf.
DR2TS10040	8000100117716	40x100x40	Richiedere	1	10



Derivazione ridotta 87° poker ad angolo

Codice	SubCodice	Riferimenti	Listino	U.M.	Conf.
DR4TS10040	8000100117686	40x40x100x40x40	Richiedere	1	10



Parafoglie in Plastica "Universale"

Codice	SubCodice	Riferimenti	Listino	U.M.	Conf.
PF60-125	0	60<>125	Richiedere	1	10

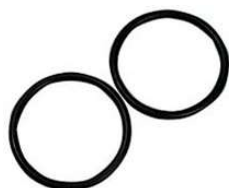

Oring per tappo a vite

Codice	SubCodice	Riferimenti	Listino	U.M.	Conf.
GTV100	0	D. 100	Richiedere	1	10
GTV125	0	D. 125	Richiedere	1	10
GTV140	0	D. 140	Richiedere	1	10

Nota bene i pezzi speciali possono essere lavorati artigianalmente con saldature professionali



Curva wc 87° uscita 100 x 110 wc

Codice	SubCodice	Riferimenti	Listino	U.M.	Conf.
CWC	0	100X110-WC	€ 3,11	1	10



Curva wc 87° uscita 100 x 110 wc attacco laterale

Codice	SubCodice	Riferimenti	Listino	U.M.	Conf.
CWC40D	0	WCx40 Dx	€ 4,00	1	10
CWC40S	0	WCx40 Sx	€ 4,00	1	10

sx



Curva wc 87° uscita 100 x 110 wc attacco laterale

Codice	SubCodice	Riferimenti	Listino	U.M.	Conf.
CWC2L40	0	WCx40 Laterale	€ 4,89	1	10



Curva wc 87° uscita 100 x 110 wc attacco laterale

Codice	SubCodice	Riferimenti	Listino	U.M.	Conf.
CWC3L40	0	WCx40 Laterale	€ 4,89	1	10

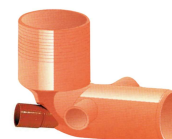

Colla per tubi arancio Riempitivo

Codice	SubCodice	Riferimenti	Listino	U.M.	Conf.
TCRP	8028530003195	gr. 125	€ 3,10	1	100
BCRP	8007174839001	gr. 500	€ 8,92	1	24
BCRP700	0	gr. 700	€ 12,96	1	24



Colla per tubi arancio Universale

Codice	SubCodice	Riferimenti	Listino	U.M.	Conf.
TCVC	0	gr. 125	€ 2,00	1	100
BCVC	0	gr. 500	€ 4,43	1	24
BCVC1	0	gr. 1000	€ 7,92	1	12



Colla per tubi Trasparente Alta Resa

Codice	SubCodice	Riferimenti	Listino	U.M.	Conf.
TTCF	0	gr. 125	€ 5,22	1	12



Scivolante in gel per tubi PVC

Codice	SubCodice	Riferimenti	Listino	U.M.	Conf.
S150	0	gr. 250	€ 1,85	1	10
S250	0		€ 2,00	1	10



Curva Aperta 45° Redi

Codice	SubCodice	Riferimenti	Listino	U.M.	Conf.
CA32R	0	D. 32 redi	€ 1,14	1	50
CA40R	0	D. 40 redi	€ 0,84	1	50
CA50R	Richiedere	D. 50 redi	Richiedere	1	50



REDI
LE STRADE DELL'ACQUA

Curva Chiusa 90° Redi

Codice	SubCodice	Riferimenti	Listino	U.M.	Conf.
CC32R	0	D. 32 redi	€ 1,04	1	50
CC40R	0	D. 40 redi	€ 0,77	1	50
CC50R	Richiedere	D. 50 redi	Richiedere	1	50



REDI
LE STRADE DELL'ACQUA

Nota bene i pezzi speciali possono essere lavorati artigianalmente con saldature professionali



Tubo in Pvc 1 mt

Codice	SubCodice	Riferimenti	Listino	U.M.	Conf.
T32X1	8000100120488	32x1	€ 2,09	1	10
T40X1	8000100120457	40x1	€ 2,65	1	10
T50X1	8000100120426	50x1	€ 3,37	1	10
T63X1	8000100120396	63x1	€ 4,35	1	10
T80X1	8000100120365	80x1	€ 4,11	1	10
T100X1	8000100120631	100x1	€ 5,14	1	10
T125X1	8000100120600	125x1	€ 6,48	1	10
T140X1	8000100120570	140x1	€ 7,60	1	10
T160X1	8000100120549	160x1	€ 9,29	1	10
T200X1	8000100120518	200x1	€ 14,62	1	10



Tubo in Pvc 2 mt

Codice	SubCodice	Riferimenti	Listino	U.M.	Conf.
T32X2	8000100120471	32x2	€ 3,95	1	10
T40X2	8000100120440	40x2	€ 5,04	1	10
T50X2	8000100120419	50x2	€ 6,41	1	10
T63X2	8000100120389	63x2	€ 8,37	1	10
T80X2	8000100120358	80x2	€ 7,81	1	10
T100X2	8000100120624	100x2	€ 9,81	1	10
T125X2	8000100120594	125x2	€ 12,36	1	10
T140X2	8000100120563	140x2	€ 14,55	1	10
T160X2	8000100120532	160x2	€ 17,80	1	10
T200X2	8000100120501	200x2	€ 27,98	1	10



Tubo in Pvc 3 mt

Codice	SubCodice	Riferimenti	Listino	U.M.	Conf.
T32X3	8000100120464	32x3	€ 5,53	1	10
T40X3	8000100120433	40x3	€ 7,06	1	10
T50X3	8000100120402	50x3	€ 8,97	1	10
T63X3	8000100120372	63x3	€ 11,01	1	10
T80X3	8000100120341	80x3	€ 10,99	1	10
T100X3	8000100120617	100x3	€ 13,80	1	10
T125X3	8000100120587	125x3	€ 17,36	1	10
T140X3	8000100120556	140x3	€ 20,42	1	10
T160X3	8000100120525	160x3	€ 25,63	1	10
T200X3	8000100120495	200x3	€ 40,32	1	10



Collare leggero per pluviale

Codice	SubCodice	Riferimenti	Listino	U.M.	Conf.
CL32	0	D. 32	€ 0,55	1	10
CL40	0	D. 40	€ 0,76	1	10
CL50	0	D. 50	€ 0,70	1	10
CL60	0	D. 63	€ 0,84	1	10
CL80	0	D. 80	€ 0,84	1	10
CL100	0	D. 100	€ 0,87	1	10
CL125	0	D. 125	€ 0,96	1	10
CL140	0	D. 140	€ 0,89	1	10
CL160	0	D. 160	€ 0,96	1	10
CL200	0	D. 200	€ 4,07	1	10



CURVA TECNICA RIDOTTA PVC ARANCIO 87°30' MF

Codice	SubCodice	Riferimenti	Listino	U.M.	Conf.
CR40X32MF	0	D. 40X32	€ 2,26	1	10
CR50X40MF	0	D. 50X40	€ 1,77	1	10



Tubo in PP 1 Bicchiere



Codice	SubCodice	Riferimenti	Mis.	Listino	U.M.	Conf.
VS0501005	0	HTEM 1 BICCHERE MT. 50 D. 32	€ 1,90	1	10	
VS0501009	0	HTEM 1 BICCHERE MT. 1,00 D. 32	€ 3,02	1	10	
VS0501013	0	HTEM 1 BICCHERE MT. 2,00 D. 32	€ 5,67	1	10	
VS0501015	0	HTEM 1 BICCHERE MT. 3,00 D. 32	€ 8,36	1	10	
VS0501025	0	HTEM 1 BICCHERE MT. 50 D. 40	€ 1,75	1	10	
VS0501029	0	HTEM 1 BICCHERE MT. 1,00 D. 40	€ 2,67	1	10	
VS0501033	0	HTEM 1 BICCHERE MT. 2,00 D. 40	€ 5,16	1	10	
VS0501035	0	HTEM 1 BICCHERE MT. 3,00 D. 40	€ 7,57	1	10	
VS0501045	0	HTEM 1 BICCHERE MT. 50 D. 50	€ 2,12	1	10	
VS0501049	0	HTEM 1 BICCHERE MT. 1,00 D. 50	€ 3,39	1	10	
VS0501053	0	HTEM 1 BICCHERE MT. 2,00 D. 50	€ 6,50	1	10	
VS0501055	0	HTEM 1 BICCHERE MT. 3,00 D. 50	€ 9,48	1	10	
VS0501145	0	HTEM 1 BICCHERE MT. 50 D. 90	€ 5,39	1	10	
VS0501149	0	HTEM 1 BICCHERE MT. 1,00 D. 90	€ 8,64	1	10	
VS0501153	0	HTEM 1 BICCHERE MT. 2,00 D. 90	€ 16,45	1	10	
VS0501155	0	HTEM 1 BICCHERE MT. 3,00 D. 90	€ 24,99	1	10	
VS0501085	0	HTEM 1 BICCHERE MT. 50 D. 110	€ 6,13	1	10	
VS0501089	0	HTEM 1 BICCHERE MT. 1,00 D. 110	€ 9,48	1	10	
VS0501093	0	HTEM 1 BICCHERE MT. 2,00 D. 110	€ 18,39	1	10	
VS0501095	0	HTEM 1 BICCHERE MT. 3,00 D. 110	€ 27,87	1	10	
VS0501125	0	HTEM 1 BICCHERE MT. 50 D. 160	€ 17,19	1	10	
VS0501129	0	HTEM 1 BICCHERE MT. 1,00 D. 160	€ 26,94	1	10	
VS0501133	0	HTEM 1 BICCHERE MT. 2,00 D. 160	€ 48,31	1	10	
VS0501135	0	HTEM 1 BICCHERE MT. 3,00 D. 160	€ 69,68	1	10	

Tubo in PP 2 Bicchiere



Codice	SubCodice	Riferimenti	Mis.	Listino	U.M.	Conf.
VS0501201	0	HTEM 2 BICCHERE MT. 50 D. 32	€ 2,65	1	10	
VS0501203	0	HTEM 2 BICCHERE MT. 1,00 D. 32	€ 3,48	1	10	
VS0501205	0	HTEM 2 BICCHERE MT. 2,00 D. 32	€ 6,41	1	10	
VS0501207	0	HTEM 2 BICCHERE MT. 3,00 D. 32	€ 8,73	1	10	
VS0501213	0	HTEM 2 BICCHERE MT. 50 D. 40	€ 2,12	1	10	
VS0501215	0	HTEM 2 BICCHERE MT. 1,00 D. 40	€ 3,12	1	10	
VS0501217	0	HTEM 2 BICCHERE MT. 2,00 D. 40	€ 5,48	1	10	
VS0501219	0	HTEM 2 BICCHERE MT. 3,00 D. 40	€ 8,22	1	10	
VS0501225	0	HTEM 2 BICCHERE MT. 50 D. 50	€ 2,65	1	10	
VS0501227	0	HTEM 2 BICCHERE MT. 1,00 D. 50	€ 3,81	1	10	
VS0501229	0	HTEM 2 BICCHERE MT. 2,00 D. 50	€ 7,29	1	10	
VS0501231	0	HTEM 2 BICCHERE MT. 3,00 D. 50	€ 10,87	1	10	
VS0501281	0	HTEM 2 BICCHERE MT. 50 D. 90	€ 6,60	1	10	
VS0501283	0	HTEM 2 BICCHERE MT. 1,00 D. 90	€ 9,85	1	10	
VS0501285	0	HTEM 2 BICCHERE MT. 2,00 D. 90	€ 17,47	1	10	
VS0501287	0	HTEM 2 BICCHERE MT. 3,00 D. 90	€ 26,11	1	10	
VS0501249	0	HTEM 2 BICCHERE MT. 50 D. 110	€ 7,90	1	10	
VS0501251	0	HTEM 2 BICCHERE MT. 1,00 D. 110	€ 11,23	1	10	
VS0501253	0	HTEM 2 BICCHERE MT. 2,00 D. 110	€ 20,81	1	10	
VS0501255	0	HTEM 2 BICCHERE MT. 3,00 D. 110	€ 30,10	1	10	

Braga Semplice a 45° in PP

Codice	SubCodice	Riferimenti	Mis.	Listino	U.M.	Conf.
VS0508001	0	BRAGA 45°	D. 32	€ 2,18	1	10
VS0508007	0	BRAGA 45°	D. 40	€ 1,60	1	10
VS0508013	0	BRAGA 45°	D. 50	€ 2,02	1	10
VS0599061	0	BRAGA 45°	D. 90	€ 5,48	1	10
VS0508025	0	BRAGA 45°	D. 110	€ 5,39	1	10
VS0508037	0	BRAGA 45°	D. 160	€ 76,77	1	10



Braga Semplice a 90° in PP

Codice	SubCodice	Riferimenti	Mis.	Listino	U.M.	Conf.
VS0508005	0	BRAGA 87° 30'	D. 32	€ 2,23	1	10
VS0508011	0	BRAGA 87° 30'	D. 40	€ 1,60	1	10
VS0508017	0	BRAGA 87° 30'	D. 50	€ 2,09	1	10
VS0599065	0	BRAGA 87° 30'	D. 90	€ 5,48	1	10
VS0508029	0	BRAGA 87° 30'	D. 110	€ 5,39	1	10
VS5008041	0	BRAGA 87° 30'	D. 160	€ 76,77	1	10



Curva MF a 90° in PP

Codice	SubCodice	Riferimenti	Mis.	Listino	U.M.	Conf.
VS0504011	0	CURVA 87° 30'	D. 32	€ 0,93	1	10
VS0504023	0	CURVA 87° 30'	D. 40	€ 0,82	1	10
VS0504035	0	CURVA 87° 30'	D. 50	€ 1,07	1	10
VS0599051	0	CURVA 87° 30'	D. 90	€ 2,79	1	10
VS0504059	0	CURVA 87° 30'	D. 110	€ 3,34	1	10
VS0504083	0	CURVA 87° 30'	D. 160	€ 21,25	1	10



Curva MF a 45° in PP

Codice	SubCodice	Riferimenti	Mis.	Listino	U.M.	Conf.
VS0504005	0	CURVA 45°	D. 32	€ 0,93	1	10
VS0504017	0	CURVA 45°	D. 40	€ 0,82	1	10
VS0504029	0	CURVA 45°	D. 50	€ 1,03	1	10
VS0599045	0	CURVA 45°	D. 90	€ 2,79	1	10
VS0504053	0	CURVA 45°	D. 110	€ 3,30	1	10
VS0504065	0	CURVA 45°	D. 125	€ 7,39	1	10
VS0504077	0	CURVA 45°	D. 160	€ 21,25	1	10



HTRE ISPEZIONE CON TAPPO

Codice	SubCodice	Riferimenti	Mis.	Listino	U.M.	Conf.
VS0516007	0		D. 110	€ 6,27	1	10



Aumento a Tappo in PP

Codice	SubCodice	Riferimenti	Mis.	Listino	U.M.	Conf.
RDEC53	0	32-50		€ 1,61	1	10
RDEC14C	0	40-110		€ 3,37	1	10



SIFONE FIRENZE

Codice	SubCodice	Riferimenti	Mis.	Listino	U.M.	Conf.
VS0533110	0	SIFONE FIRENZE	D. 110	€ 32,31	1	10





TRONCHETTO COLLEGAMENTO

Codice	SubCodice	Riferimenti	Mis.	Listino	U.M.	Conf.
VS0564121	0	D. 40/40		€ 3,26	1	10
VS0564123	0	D. 50/50		€ 3,34	1	10
VS0564190	0	D. 90/100		€ 7,79	1	10
VS0564101	0	D. 110/110		€ 10,84	1	10



TAPPO DI CHIUSURA

Codice	SubCodice	Riferimenti	Mis.	Listino	U.M.	Conf.
VS0524001	0	D. 40		€ 0,55	1	10
VS0524003	0	D. 50		€ 0,69	1	10
VS0599141	0	D. 90		€ 1,77	1	10
VS024007	Richiedere	D. 110		Richiedere	1	10



Manicotto FF in PP

Codice	SubCodice	Riferimenti	Mis.	Listino	U.M.	Conf.
VS0528000	0	Manicotto FF	D. 32	€ 1,77	1	10
VS0528001	0	Manicotto FF	D. 40	€ 1,23	1	10
VS0528003	0	Manicotto FF	D. 50	€ 1,75	1	10
VS0599111	0	Manicotto FF	D. 90	€ 3,48	1	10
VS0528007	0	Manicotto FF	D. 110	€ 3,62	1	10
VS0528011	Richiedere	Manicotto FF	D. 160	Richiedere	1	10



Bicchere Aumento in PP

Codice	SubCodice	Riferimenti	Listino	U.M.	Conf.
VS0514001	0	HTR AUMENTI ECCENTRICID. 40-32	€ 1,37	1	10
VS0514002	0	HTR AUMENTI ECCENTRICID. 50-32	€ 1,61	1	10
VS0514003	0	HTR AUMENTI ECCENTRICID. 50-40	€ 0,94	1	10
VS0513001	0	Bicchere AumentoD. 50-40	€ 1,52	1	10
VS0599131	0	HTR AUMENTI ECCENTRICID. 90-40	€ 3,25	1	10
VS0599133	0	HTR AUMENTI ECCENTRICID. 90/50	€ 2,28	1	10
VS0514008	0	HTR AUMENTI ECCENTRICID. 110-40	€ 2,35	1	10
VS0514009	0	HTR AUMENTI ECCENTRICID. 110-50	€ 2,42	1	10
RDEC19	0	HTR AUMENTI ECCENTRICID. 110-90	€ 3,76	1	10
VS0514015	0	HTR AUMENTI ECCENTRICID. 125/110	€ 6,88	1	10



HTEA braga ridotta 45°

Codice	SubCodice	Riferimenti	Mis.	Listino	U.M.	Conf.
VS0510001	0	D.40/32		€ 2,40	1	10
VS0599071	0	D.90/40		€ 3,63	1	10
VS0599073	0	D.90/50		€ 3,74	1	10
VS0510025	0	D.110/40		€ 3,11	1	10
VS0599089	0	D.110/90		€ 9,79	1	10
VS0510031	0	D.110/50		€ 3,64	1	10
VS0510061	0	D.160/110		€ 49,82	1	10



Braga ridotta 87° 30"

Codice	SubCodice	Riferimenti	Mis.	Listino	U.M.	Conf.
VS0599075	0	D.90/40		€ 3,63	1	10
VS0599077	0	D.90/50		€ 3,90	1	10
VS0510029	0	D.110/40		€ 3,74	1	10
VS0510035	0	D.110/50		€ 3,67	1	10
VS0510065	0	D.160/110		€ 81,37	1	10



Tronchetto per collegamento Pvc

Codice	SubCodice	Riferimenti	Mis.	Listino	U.M.	Conf.
VS0530001	0	D.40		€ 3,34	1	10
VS0530003	0	D.50		€ 3,81	1	10
VS0599121	0	D.90		€ 8,60	1	10
VS0530007	0	D.110		€ 7,06	1	10



Tronchetto per collegamento Pvc

Codice	SubCodice	Riferimenti	Mis.	Listino	U.M.	Conf.
VS0530001	0	D.40		€ 3,34	1	10
VS0530003	0	D.50		€ 3,81	1	10
VS0599121	0	D.90		€ 8,60	1	10
VS0530007	0	D.110		€ 7,06	1	10



HTSW curva tecnica completa, senza morsetto con tappo

Codice	SubCodice	Riferimenti	Mis.	Listino	U.M.	Conf.
VS0518113	0	D.40		€ 1,28	1	10
VS0518117	0	D.50		€ 1,35	1	10
VS051807	Richiedere	D.40/46		Richiedere	1	10



AUMENTO CONCENTRICO 90/110

Codice	SubCodice	Riferimenti	Mis.	Listino	U.M.	Conf.
VS0599161	0	D.90/110		€ 5,59	1	10

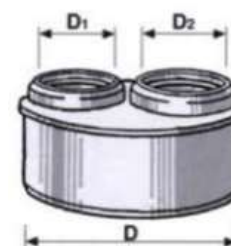

RACCORDO WC PP HTSK D.110X230"ZC"

Codice	SubCodice	Riferimenti	Mis.	Listino	U.M.	Conf.
VS0536001	0	D.110		€ 5,83	1	10



RACCORDO SELLA

Codice	SubCodice	Riferimenti	Mis.	Listino	U.M.	Conf.
SL104	0	100X40		€ 5,55	1	10
SL124	0	125X40		€ 4,78	1	10

Sella



Curve Tecniche ad incollaggio

Codice	SubCodice	Riferimenti	Mis.	Listino	U.M.	Conf.
CR40X32FF	0	D. 40 F x 32 F		€ 1,52	1	10
CR40X32FM	Richiedere	D. 40 F x 32 M		Richiedere	1	10
C40FF	0	D. 40 F x 40 F		€ 1,86	1	10



DESCRIZIONE

Il cavidotto corrugato è un tubo in polietilene particolarmente adatto alla protezione dei cavi nelle installazioni elettriche e di telecomunicazione interrate.

CARATTERISTICHE CAVIDOTTO CORRUGATO

Il cavidotto a doppia parete CORRUGAR è costituito da due tubolari coestrusi e sagomati in modo che la parete interna, in polietilene bassa densità, resti continua e liscia, mentre quella esterna, in polietilene alta densità, assuma la tipica corrugazione necessaria a conferire al manufatto un'adeguata resistenza strutturale.

L'estrema cura dell'imballo consente un agevole stoccaggio in magazzino grazie ad un razionale packaging che rende le matasse facilmente impilabili; una particolare additivazione garantisce per 18 mesi lo stoccaggio anche a cielo aperto.

MATERIALI CAVIDOTTO CORRUGATO A DOPPIA PARETE

Sia la parte esterna sia quella interna sono realizzate con materiali di prima scelta non rigenerati, garanzia di qualità e lunga durata del manufatto. Inoltre, la qualità delle materie prime selezionate per la fabbricazione assicura l'assenza di memoria plastica nel cavidotto facilitando la posa in trincea.

Il prodotto abbina doti di estrema leggerezza e flessibilità assieme ad una resistenza allo schiacciamento di valore tale da poter essere utilizzato senza particolari precauzioni di posa in opera.

Tubo corrugato in HDPE Cavidotto

Codice	Riferimenti	Listino	U.M.	Conf.
CAV40	D. 40X31	€ 1,62	1	50
CAV50	D. 50X40	€ 1,95	1	50
CAV63	D. 63X50	€ 2,40	1	50
CAV75	D. 75X60	€ 1,67	1	50
CAV90	D. 90X73	€ 2,17	1	50
CAV110	D. 110X92	€ 2,69	1	50
CAV125	D. 125X105	€ 3,38	1	50
CAV140	D. 140X120	€ 4,05	1	50
CAV160	D. 160X137	€ 5,35	1	50
CAV200	D. 200X171	€ 9,87	1	50



TUBO CORRUGATO NERO

Sistemi di tubazioni di materia plastica per connessioni di scarico e collettori di fognatura interrati non in pressione:
 Sistemi di tubazioni a parete strutturata di PVC-U, PP e PE Superficie interna liscia e superficie esterna profilata (UNI EN 13476-3)
 Classe di rigidità anulare (SN): SN 4 - 8 KPa (tubi in PE)
 Tubi in barre da mt. 6 - Bicchiere e guarnizione.

SISTEMA DI GIUNZIONE PER TUBI / Joint system profile for pipes / Système de jonction pour tubes

DN/OD ≤ 1000 E DN/ID ≤ 600

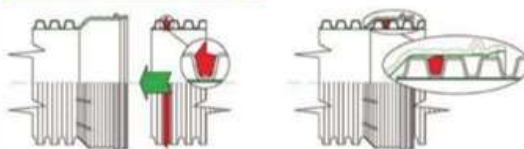

PROFILO COSTOLA PER
 Outside layer profile for
 Profilé paroi annéelée pour
 STANDARD DN/OD

PROFILO COSTOLA
 Outside layer profile for
 Profilé paroi annéelée pour
 STANDARD DN/ID

Tubo corrugato in HDPE Drenaggio

Codice	Riferimenti	Listino	U.M.	Conf.
DREN63	D. 63X50	1,54 €	1	50
DREN75	D. 75X60	1,70 €	1	50
DREN90	D. 90X73	2,42 €	1	50
DREN110	D. 110X92	3,01 €	1	50
DREN125	D. 125X105	3,77 €	1	50
DREN140	D. 140X120	4,05 €	1	50
DREN160	D. 160X137	5,97 €	1	50
DREN200	D. 200X171	11,01 €	1	50





TELAIO + GRIGLIA

Codice	Riferimenti	Listino
UTG20PP	200X200	3,44 €
UTG30PP	300X300	6,88 €
UTG40PP	400X400	13,76 €
UTG55PP	550X550	32,69 €

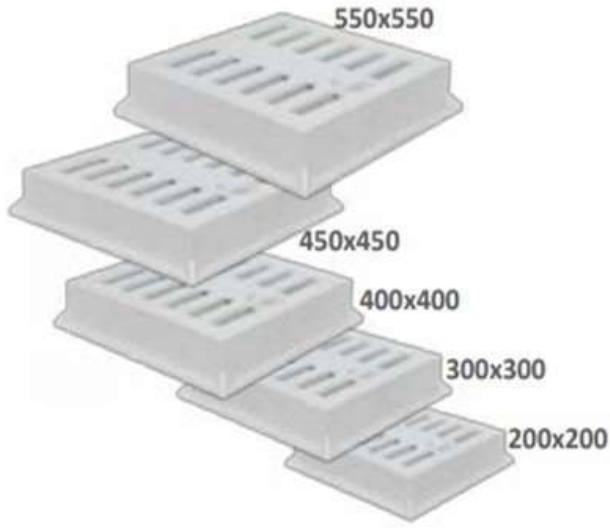

CHIUSINO SIFONATO

Codice	Riferimenti	Listino
CS10PP	10X10	1,41 €
CS15PP	15X15	2,25 €



Chiusino 10x10 Sifonato Usc. 40

Codice	Riferimenti	Listino
CHABS1040G	Grigio	7,10 €
CHABS1040M	Cromo	10,93 €

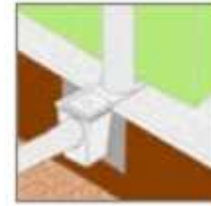

Pozzetto pluviale universale usc. tonde 80-82-90-100-110

Codice	Riferimenti	Listino
PPU	Grigio	5,65 €

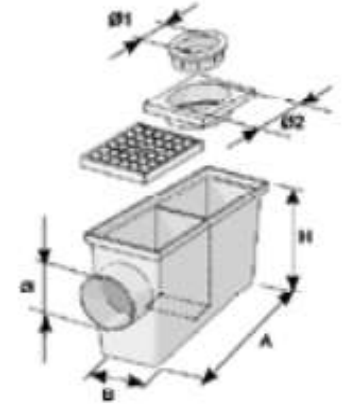

POZZETTO & COPERCHIO

Codice	Riferimenti	Listino
PUC20PP	200X200	4,39 €
PUC30PP	300X300	10,63 €
PUC40PP	400X400	21,76 €
PUC55PP	550X550	65,53 €



TELAIO + COPERCHIO

Codice	Riferimenti	Listino
UTC20PP	200X200	3,44 €
UTC30PP	300X300	6,88 €
UTC40PP	400X400	13,76 €
UTC55PP	550X550	32,69 €

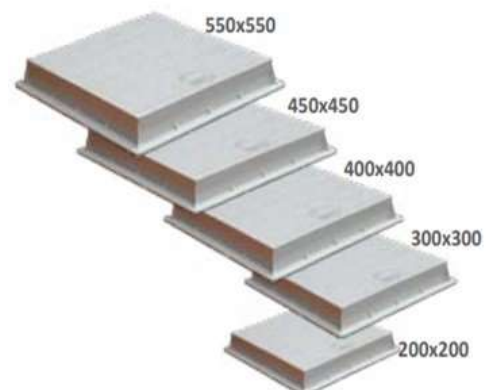

PROFESSIONALITA' E QUALITA'



EVOKlima™

TECNOLOGIA - BENESSERE - RISPETTO PER L'AMBIENTE

