

2020-2021

CLIMATIZZATORI - CALDAIE - SCALDABAGNI ELETTRICI & GAS

www.fcdistribution.net
info@fcdistribution.net





www.bandiniwaterheaters.it



MADE IN ITALY

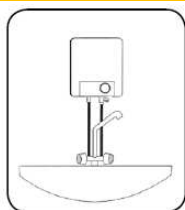
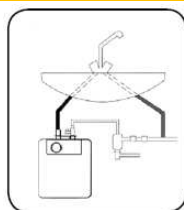

Codice	RIFERIMENTI	Listino
A5SP2A	5 LT Sopr. 2A	€ 108,81
A5ST2A	5 LT Sott. 2A	€ 108,81
A5SP5A	5 LT Sopr. 5A	€ 137,40
A5ST5A	5 LT Sott. 5A	€ 137,40

modello	H	L	P	
A5 SP	mm 340	250	245	sopralavello
A5 ST	mm 340	250	245	sottolavello

MODELLO	Profilo	Classe Energetica	dispersione termica 65°C (Kwh/24h)	Potenza W	Voltaggio V	Tempo di Risc. dt 50°C	Temp. Max esercizio C°	Pressione Max esercizio (bar)
A5	XXS	B	0,38	1500	230	16'	50	8

Codice	RIFERIMENTI	Listino
A12SP2A	12 LT Sopr. 2A	€ 96,38
A12ST2A	12 LT Sott. 2A	€ 96,38
A12SP5A	12 LT Sopr. 5A	€ 111,60
A12ST5A	12 LT Sott. 5A	€ 111,60

modello	H	L	P	
A12 SP	mm 410	350	220	sopralavello
A12 ST	mm 410	350	220	sottolavello

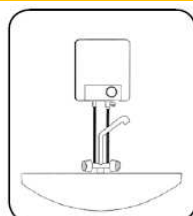
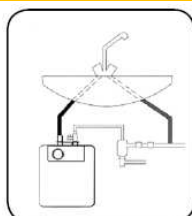

MODELLO	Profilo	Classe Energetica	dispersione termica 65°C (Kwh/24h)	Potenza W	Voltaggio V	Tempo di Risc. dt 50°C	Temp. Max esercizio C°	Pressione Max esercizio (bar)
A12 SP	XXS	B	0,38	1500	230	30'	75	8
A12 ST	XXS	C	0,38	1500	230	30'	75	8

Codice	RIFERIMENTI	Listino
A15SP2A	15 LT Sopr. 2A	€ 115,93
A15ST2A	15 LT Sott. 2A	€ 115,93
A15SP5A	15 LT Sopr. 5A	€ 149,20
A15ST5A	15 LT Sott. 5A	€ 149,20

modello	H	L	P	
A15 SP	mm 410	350	260	sopralavello
A15 ST	mm 410	350	260	sottolavello

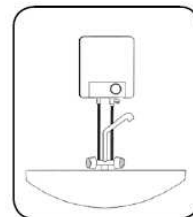
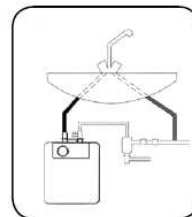

MODELLO	Profilo	Classe Energetica	dispersione termica 65°C (Kwh/24h)	Potenza W	Voltaggio V	Tempo di Risc. dt 50°C	Temp. Max esercizio C°	Pressione Max esercizio (bar)
A15 SPTR	XXS	B	0,42	1500	230	32'	65	8
A15 STTR	XXS	C	0,42	1500	230	32'	65	8
A15 SP	XXS	B	0,42	1500	230	32'	65	8
A15 ST	XXS	C	0,42	1500	230	32'	65	8

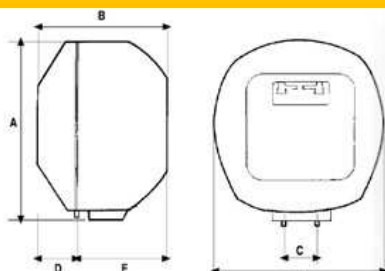

modello	A	B	C	D	E	F
B30	mm	535	325	100	120	205

SCocca IN PLASTICA

Codice	RIFERIMENTI	Listino
B302A	30 LT Sopr. 2A	€ 167,40
B305A	30 LT Sopr. 5A	€ 190,00

MODELLO	Profilo	Classe Energetica	dispersione termica 65°C (Kwh/24h)	Potenza W	Voltaggio V	Tempo di Risc. dt 50°C	Temp. Max esercizio C°	Pressione Max esercizio (bar)
B30	S	C	0,70	1500	230	75'	75	8

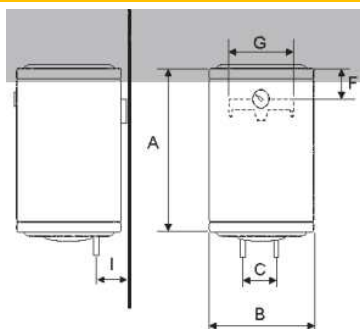

modello	A	B	C	F	G	I
SE50	mm	510	460	100	130	350
SE80	mm	700	460	100	130	350
SE100	mm	805	460	100	130	350
SE120	mm	1000	460	100	130	350
SE150	mm	935	550	140	180	350
SE200	mm	1105	550	140	180	350

Codice	RIFERIMENTI	Listino
SE502A	50 LT Vert. 2 A	€ 136,96
SE802A	80 LT Vert. 2 A	€ 142,04
SE1002A	100 LT Vert. 2 A	€ 220,05
SE1202A	120 LT Vert. 2 A	€ 310,22
SE1502A	150 LT Vert. 2 A	€ 404,70
SE2002A	200 LT Vert. 2 A	€ 432,60
SE505A	50 LT Vert. 5 A	€ 167,40
SE805A	80 LT Vert. 5 A	€ 181,35
SE1005A	100 LT Vert. 5 A	€ 274,82
SE1205A	120 LT Vert. 5 A	€ 373,55
SE1505A	150 LT Vert. 5 A	€ 519,55
SE2005A	200 LT Vert. 5 A	€ 552,84

MODELLO	Profilo	Classe Energetica	dispersione termica 65°C (Kwh/24h)	Potenza W	Voltaggio V	Tempo di Risc. dt 50°C	Temp. Max esercizio C°	Pressione Max esercizio (bar)
SE50	M	D	0,98	1200	230	170'	75	8
SE80	M	D	1,32	1200	230	260'	75	8
SE100	M	D	1,51	1500	230	245'	75	8
SE120	L	D	1,84	1500	230	315'	75	8
SE150	L	D	2,09	2000	230	416'	75	8
SE200	L	D	2,41	2000	230	499'	75	8

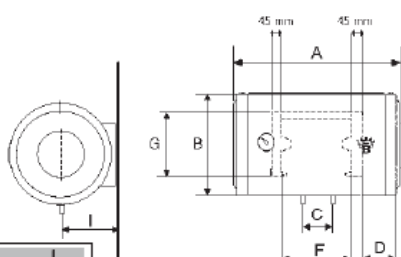

modello	A	B	C	D	F	G	I
SO50	mm	510	460	100	155	125	350
SO80	mm	700	460	100	145	330	350
SO100	mm	805	460	100	145	435	350
SO120	mm	1000	460	100	210	510	350
SO150	mm	935	550	140	210	450	350
SO200	mm	1105	550	140	190	640	350

Codice	RIFERIMENTI	Listino
SO502ADX	50 LT Oriz. Dx-Sx 2 A	€ 224,34
SO802ADX	80 LT Oriz. Dx-Sx 2 A	€ 237,15
SO1002ADX	100 LT Oriz. Dx-Sx 2 A	€ 264,07
SO1202ADX	120 LT Oriz. Dx-Sx 2 A	€ 392,90
SO1502ADX	150 LT Oriz. Dx-Sx 2 A	€ 490,57
SO2002ADX	200 LT Oriz. Dx-Sx 2 A	€ 532,44
SO502ADX	50 LT Oriz. Dx-Sx 5 A	€ 224,34
SO802ADX	80 LT Oriz. Dx-Sx 5 A	€ 237,15
SO1002ADX	100 LT Oriz. Dx-Sx 5 A	€ 264,07
SO1202ADX	120 LT Oriz. Dx-Sx 5 A	€ 392,90
SO1502ADX	150 LT Oriz. Dx-Sx 5 A	€ 490,57
SO2002ADX	200 LT Oriz. Dx-Sx 5 A	€ 532,44

MODELLO	Profilo	Classe Energetica	dispersione termica 65°C (Kwh/24h)	Potenza W	Voltaggio V	Tempo di Risc. dt 50°C	Temp. Max esercizio C°	Pressione Max esercizio (bar)
SO50	M	D	1,11	1500	230	170'	75	8
SO80	M	D	1,61	1500	230	260'	75	8
SO100	M	D	1,66	1500	230	245'	75	8
SO120	L	D	2,02	1500	230	315'	75	8
SO150	L	D	2,29	2000	230	416'	75	8
SO200	L	D	2,55	2000	230	499'	75	8

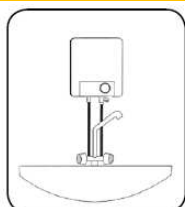
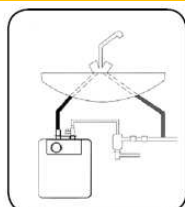

Codice	RIFERIMENTI	Listino
A5SP2A	5 LT Sopr. 2A	€ 108,81
A5ST2A	5 LT Sott. 2A	€ 108,81
A5SP5A	5 LT Sopr. 5A	€ 137,40
A5ST5A	5 LT Sott. 5A	€ 137,40

modello	H	L	P	
A5 SP	mm 340	250	245	sopralavello
A5 ST	mm 340	250	245	sottolavello

MODELLO	Profilo	Classe Energetica	dispersione termica 65°C (Kwh/24h)	Potenza W	Voltaggio V	Tempo di Risc. dt 50°C	Temp. Max esercizio C°	Pressione Max esercizio (bar)
A5	XXS	B	0,38	1500	230	16'	50	8

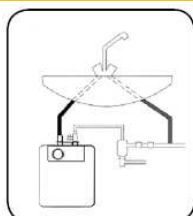

Codice	RIFERIMENTI	Listino
A12SP2A	12 LT Sopr. 2A	€ 96,38
A12ST2A	12 LT Sott. 2A	€ 96,38
A12SP5A	12 LT Sopr. 5A	€ 111,60
A12ST5A	12 LT Sott. 5A	€ 111,60

modello	H	L	P	
A12 SP	mm 410	350	220	sopralavello
A12 ST	mm 410	350	220	sottolavello

MODELLO	Profilo	Classe Energetica	dispersione termica 65°C (Kwh/24h)	Potenza W	Voltaggio V	Tempo di Risc. dt 50°C	Temp. Max esercizio C°	Pressione Max esercizio (bar)
A12 SP	XXS	B	0,38	1500	230	30'	75	8
A12 ST	XXS	C	0,38	1500	230	30'	75	8

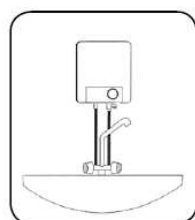
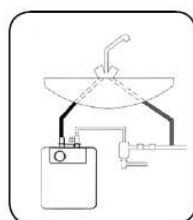

Codice	RIFERIMENTI	Listino
A15SP2A	15 LT Sopr. 2A	€ 115,93
A15ST2A	15 LT Sott. 2A	€ 115,93
A15SP5A	15 LT Sopr. 5A	€ 149,20
A15ST5A	15 LT Sott. 5A	€ 149,20

modello	H	L	P	
A15 SP	mm 410	350	260	sopralavello
A15 ST	mm 410	350	260	sottolavello

MODELLO	Profilo	Classe Energetica	dispersione termica 65°C (Kwh/24h)	Potenza W	Voltaggio V	Tempo di Risc. dt 50°C	Temp. Max esercizio C°	Pressione Max esercizio (bar)
A15 SPTR	XXS	B	0,42	1500	230	32'	65	8
A15 STTR	XXS	C	0,42	1500	230	32'	65	8
A15 SP	XXS	B	0,42	1500	230	32'	65	8
A15 ST	XXS	C	0,42	1500	230	32'	65	8

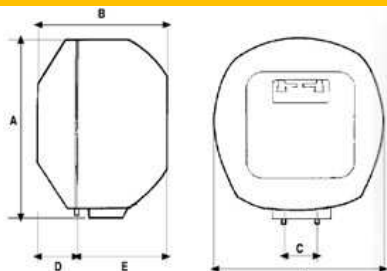

modello	A	B	C	D	E	F
B30	mm	535	325	100	120	205

SCocca IN PLASTICA

Codice	RIFERIMENTI	Listino
B302A	30 LT Sopr. 2A	€ 167,40
B305A	30 LT Sopr. 5A	€ 190,00

MODELLO	Profilo	Classe Energetica	dispersione termica 65°C (Kwh/24h)	Potenza W	Voltaggio V	Tempo di Risc. dt 50°C	Temp. Max esercizio C°	Pressione Max esercizio (bar)
B30	S	C	0,70	1500	230	75'	75	8

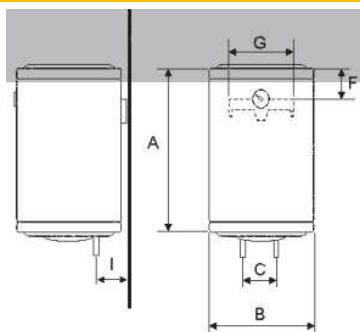

modello	A	B	C	F	G	I
SE50	mm	510	460	100	130	350
SE80	mm	700	460	100	130	350
SE100	mm	805	460	100	130	350
SE120	mm	1000	460	100	130	350
SE150	mm	935	550	140	180	350
SE200	mm	1105	550	140	180	350

Codice	RIFERIMENTI	Listino
SE502A	50 LT Vert. 2 A	€ 136,96
SE802A	80 LT Vert. 2 A	€ 142,04
SE1002A	100 LT Vert. 2 A	€ 220,05
SE1202A	120 LT Vert. 2 A	€ 310,22
SE1502A	150 LT Vert. 2 A	€ 404,70
SE2002A	200 LT Vert. 2 A	€ 432,60
SE505A	50 LT Vert. 5 A	€ 167,40
SE805A	80 LT Vert. 5 A	€ 181,35
SE1005A	100 LT Vert. 5 A	€ 274,82
SE1205A	120 LT Vert. 5 A	€ 373,55
SE1505A	150 LT Vert. 5 A	€ 519,55
SE2005A	200 LT Vert. 5 A	€ 552,84

MODELLO	Profilo	Classe Energetica	dispersione termica 65°C (Kwh/24h)	Potenza W	Voltaggio V	Tempo di Risc. dt 50°C	Temp. Max esercizio C°	Pressione Max esercizio (bar)
SE50	M	D	0,98	1200	230	170'	75	8
SE80	M	D	1,32	1200	230	260'	75	8
SE100	M	D	1,51	1500	230	245'	75	8
SE120	L	D	1,84	1500	230	315'	75	8
SE150	L	D	2,09	2000	230	416'	75	8
SE200	L	D	2,41	2000	230	499'	75	8

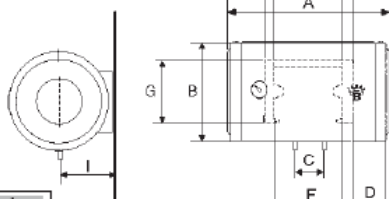

modello	A	B	C	D	F	G	I
SO50	mm	510	460	100	155	125	350
SO80	mm	700	460	100	145	330	350
SO100	mm	805	460	100	145	435	350
SO120	mm	1000	460	100	210	510	350
SO150	mm	935	550	140	210	450	350
SO200	mm	1105	550	140	190	640	350

Codice	RIFERIMENTI	Listino
SO502ADX	50 LT Oriz. Dx-Sx 2 A	€ 224,34
SO802ADX	80 LT Oriz. Dx-Sx 2 A	€ 237,15
SO1002ADX	100 LT Oriz. Dx-Sx 2 A	€ 264,07
SO1202ADX	120 LT Oriz. Dx-Sx 2 A	€ 392,90
SO1502ADX	150 LT Oriz. Dx-Sx 2 A	€ 490,57
SO2002ADX	200 LT Oriz. Dx-Sx 2 A	€ 532,44
SO502ADX	50 LT Oriz. Dx-Sx 5 A	€ 224,34
SO802ADX	80 LT Oriz. Dx-Sx 5 A	€ 237,15
SO1002ADX	100 LT Oriz. Dx-Sx 5 A	€ 264,07
SO1202ADX	120 LT Oriz. Dx-Sx 5 A	€ 392,90
SO1502ADX	150 LT Oriz. Dx-Sx 5 A	€ 490,57
SO2002ADX	200 LT Oriz. Dx-Sx 5 A	€ 532,44

MODELLO	Profilo	Classe Energetica	dispersione termica 65°C (Kwh/24h)	Potenza W	Voltaggio V	Tempo di Risc. dt 50°C	Temp. Max esercizio C°	Pressione Max esercizio (bar)
SO50	M	D	1,11	1500	230	170'	75	8
SO80	M	D	1,61	1500	230	260'	75	8
SO100	M	D	1,66	1500	230	245'	75	8
SO120	L	D	2,02	1500	230	315'	75	8
SO150	L	D	2,29	2000	230	416'	75	8
SO200	L	D	2,55	2000	230	499'	75	8



comfort e risparmio



Codice	Riferimenti	Prezzo
SV50\5A	ARISTON VERT. 50LT. 5 ANNI	ZZ € 250,60
SV80\5A	ARISTON VERT. 80 LT.5 ANNI	ZZ € 251,70

alte prestazioni



Codice	Riferimenti	Prezzo
SV50A	Ariston 3 anni LT. 50 VERT.	ZZ € 198,13
SV80A	Ariston 3 anni LT. 80 VERT.	ZZ € 199,20



Codice	Riferimenti	Prezzo
SO80\5A	ARISTON ORIZZ. 80LT. 5 ANNI	€ 309,52



Codice	Riferimenti	Prezzo
SO80A	SCALDABAGNO ARISTON LT. 80	€ 237,44

super compatto



Codice	Riferimenti	Prezzo
S10\5A	ARISTON SOPR. 10 LT. 5 /ANNI	€ 140,50
SS10\5A	Ariston 5 anni LT. 10 SOTT.	€ 147,60
S30\5A	ARISTON SOPR. 30 LT. 5 /ANNI	€ 200,18

installazione versatile



Codice	Riferimenti	Prezzo
S10A	Ariston 3 anni LT. 10 SOPR.	ZZ € 114,58
SS10A	Ariston 3 anni LT. 10 SOTT.	€ 119,37
S30A	Ariston 3 anni LT. 30	€ 158,90

ARISTON



CALDAIA MURALE A CONDENSAZIONE La caldaia murale CARES Premium coniuga la tecnologia della condensazione con la praticità installativa e la compattezza delle dimensioni. Cares Premium è disponibile nella versione riscaldamento e produzione acqua calda sanitaria nelle potenze di 24 e 30 kW

Trasformabile Metano-Gpl

Codice	Riferimenti	Prezzo	Codice Aziendale
CP24FF	24 Kw	€ 1.504,79	3301119
CP30FF	30 Kw	€ 1.859,17	3301120

kit Scarico coassiale 60/100 XX caldaia condensazione



Codice	Riferimenti	Prezzo
3318073	Kit fumo	€ 56,92

FAST EVO PREMIUM Scaldacqua a gas istantaneo a camera Stagna



Codice	Riferimenti	Prezzo
3318517	x fast evo Es.	€ 57,00
3318932	x fast evo New	€ 57,00



FAST EVO PREMIUM Scaldacqua a gas istantaneo a camera Stagna

Codice	Riferimenti	Prezzo
F11FFIM	11 LT MET	€ 755,40
F16FFIM	16 LT MET	€ 856,08
F11FFIG	11 LT GPL	€ 755,40
F16FFIG	16 LT GPL	€ 856,08



FAST EVO C/B Scaldacqua a gas istantaneo a camera aperta

Codice	Riferimenti	Prezzo
F11FIM	11 LT MET	€ 334,41
F14FIM	14 LT MET	€ 406,89
F16FIM	16 LT MET	€ 452,45
F11FIG	11 LT GPL	€ 334,41
F14FIG	14 LT GPL	€ 406,89
F16FIG	16 LT GPL	€ 452,45



Stufe a Gas

Gazzelle Evo

Metano

GPL



fondital
BE INNOVATIVE

Codice	Riferimenti	Listino	Codice	Riferimenti	Listino
GEIT301PR2	w3000	€ 1.143,90	GEIT361PR2	w3000	€ 1.206,40
GEIT501PR2	w5000	€ 1.188,54	GEIT561PR2	w5000	€ 1.250,00
GEIT701PR2	w7000	€ 1.244,34	GEIT761PR2	w7000	€ 1.309,07

Caratteristiche

Codice	Pot. Termica Nominale	Rid.	Pot.Nom.	Rid.
GEIT301PR2	w2900	2000	2720	1989
GEIT501PR2	w4900	3000	4610	3030
GEIT501PR2	w6400	4500	6280	4730

Radiatore a Gs Modello Stratos completo di kit Fumi standard



Italkero



Colore	Codice	Riferimenti	Listino
BIANCO	SR30	2,30 KW	€ 1.048,90
BIANCO	SR50	4,34 KW	€ 1.178,25
BIANCO	SR70	6,25 KW	€ 1.380,00
BIANCO	SR90	7,74 KW	€ 1.764,45
SILVER	SR30S	2,30 KW	€ 1.080,40
SILVER	SR50S	4,34 KW	€ 1.213,60
SILVER	SR70S	6,25 KW	€ 1.421,40
SILVER	SR90S	7,74 KW	€ 1.817,40

CALORIO M

RADIATORE INDIVIDUALE MODULANTE A METANO



	W	GAS	D. TUBI
CALORIO 42M	3,62	0,383	49 35
CALORIO 52M	5,23	0,553	49 35

CODICE	DESCRIZIONE	Listino
F11380439	CALORIO 42M	€ 1.331,96
F11385439	CALORIO 52M	€ 1.391,16

SUPERCROMO

RADIATORE INDIVIDUALE A METANO



	W	GAS	D. TUBI
SUPERCROMO 3001	2,58	0,273	49 35
SUPERCROMO 3002	2,58	0,273	49 35

CODICE	DESCRIZIONE	Listino
F11327430	SUPERCROMO 3001	€ 1.050,77
F11328430	SUPERCROMO 3002	€ 1.120,74

Stufa Pellet Kw 7 Freepoint Indigo



FreePoint

INDIGO STUFA AIR

Codice	RIFERIMENTI	Listino
70190055	BORDEAUX	€ 1.074,71
70190056	BIANCO	€ 1.074,71
70190054	ANTRACITE	€ 1.074,71

Pot. nominale: Kw 7 . Pot. ridotta : Kw 2,5 . Pot. focolare (max) : Kw 7,67
 Rend. nominale: 90% . Volume riscaldabile (min-max) : 57- 156 m3
 CO al 13% O2 nominale : 0,036 . CO al 13% O2 ridotto : 0,025
 Emissioni CO (13% O2) (min-max) : 240-280 mg/nm3
 Emissioni OGC (13% O2) (min-max) : 1,0- 2,0 mg/nm3
 Emissioni NOX (13% O2) (min-max) : 113-112 mg/nm3
 Contenuto di polveri al 13% O2 (min-max) : 12-12 mg/nm3
 Specifiche Tecniche : Capacità serbatoio : 15kg
 Combustibile Consumo orario (min-max):0,57- 1,65 kg/h
 Autonomia (min-max) : 9- 26,3h
 Assorbimento elettrico in accensione (max): 320W
 Assorbimento elettrico in lavoro (max): 40W
 Tensione di alimentazione e frequenza : 230V/40Hz
 Depressione canna fumaria: Pa10 . Diametro scarico fumi : 80mm
 Diametro ingresso aria comburente: 60mm
 Massa fumi (min-max) : 2,8-4,8 gr/sec

Stufa Pellet Kw 8,7 Freepoint Pretty Airtight



FreePoint

PRETTY STUFA AIR

Codice	RIFERIMENTI	Listino
7018015	BORDEAUX	€ 1.697,44
7018014	ANTRACITE	€ 1.697,44

Caratteristiche Tecniche:
 Potenza nominale 8,7 Kw
 Potenza ridotta 2,3 Kw
 Rendimento nominale 88 %
 Rendimento ridotto 90 %
 Volume riscaldabile (min-max) 55 - 207 m3
 CO al 13% O2 nominale 0,006%
 CO al 13% O2 ridotto 0,031 %
 Capacità serbatoio 18 Kg
 Combustibile: Pellet oslash;6
 Consumo
 Consumo orario (min - max) 0,5 - 1,9 Kg/h
 Autonomia (min - max) 36 - 9,5 h
 Assorbimento elettrico in accensione (max) 364 W
 Assorbimento elettrico in lavoro (max) 59 W
 Tensione di alimentazione e frequenza 230 - 50 V - Hz



ECOTEC PURE VMW

		classe	
Per Gas	Potenza Kw	RISC. ErP	SAN. ErP
metano	7,5-24,0	A	A

PROD. H₂O l/min: 13,5

COMBINATE DA INTERNO CAMERA STAGNA

Articolo VMW246/7-2 Listino € 1.597,17 Più Rae



EVOLution Prime

		classe	
Per Gas	Potenza Kw	RISC. ErP	SAN. ErP
metano	26 KW	A	A

PROD. H₂O l/min: 13,8

COMBINATE DA INTERNO CAMERA STAGNA

Articolo A7715732 Listino € 1.686,51 Più Rae



ECOTEC INTRO VMW

		classe	
Per Gas	Potenza Kw	RISC. ErP	SAN. ErP
metano	6,5-20,0	A	A

PROD. H₂O l/min: 9,9

COMBINATE DA INTERNO CAMERA STAGNA

Articolo VMW18/24AS Listino € 1.422,48 Più Rae



EVOLution Prime

		classe	
Per Gas	Potenza Kw	RISC. ErP	SAN. ErP
metano	30 KW	A	A

PROD. H₂O l/min: 16,1

COMBINATE DA INTERNO CAMERA STAGNA

Articolo A7727156 Listino € 1.832,08 Più Rae



ECOTEC INTRO VMW

		classe	
Per Gas	Potenza Kw	RISC. ErP	SAN. ErP
metano	7,7-25,9	A	A

PROD. H₂O l/min: 11,5

COMBINATE DA INTERNO CAMERA STAGNA

Articolo VMW24/28AS Listino € 1.523,06 Più Rae

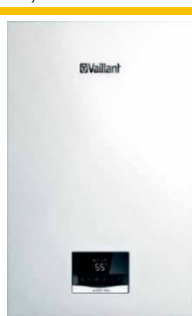

CIAO AT

		classe	
Per Gas	Potenza Kw	RISC. ErP	SAN. ErP
metano	25 KW	A	A

PROD. H₂O l/min: 14

COMBINATE DA INTERNO CAMERA STAGNA

Articolo 20151635 Listino € 1.299,02 Più Rae



Condens 2300 W Caldaia a Condensazione

Codice	RIFERIMENTI	Listino
7736901294	24<>25 KW	22
7736901286	24<>30 KW	€ 1.901,73

Kit base d. 60/100 est. 500<>1000 mm

Codice	RIFERIMENTI	Listino
7738112497	AZB916	€ 117,48



Cerapuy Balcony Caldaia a Condensazione

Codice	RIFERIMENTI	Listino
7736900515	24 KW	€ 2.744,32
7736900516	24<>28 KW	€ 3.028,22

Kit base d. 60/100 est. 500<>1000 mm

Codice	RIFERIMENTI	Listino
7738112497	AZB916	€ 117,48



Scaldabagno a gas istantaneo a camera aperta e tiraggio naturale **Therm 4200**

Codice	RIFERIMENTI	Listino
7736504163	12 met	€ 406,96
7736504909	12 gpl	€ 406,96

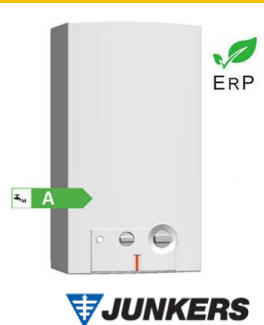

Scaldabagno a gas istantaneo Low NOx a camera stagna e **Therm 5600 S**

Codice	RIFERIMENTI	Listino
7736504984	12 met	€ 877,37
7736504985	12 gpl	€ 877,37
7736504986	15 met	€ 1.011,21
7736504987	15 gpl	€ 1.011,21
7736504988	17 met	€ 1.159,91
7736504989	17 gpl	€ 1.159,91



SCALDABAGNI A CAMERA APERTA **atmoMAG Tipo B**

Codice	RIFERIMENTI	Listino
VAM11M	11,0 Met	€ 449,47
VAM11G	11,0 Gpl	€ 449,47
VAM14M	14,0 Met	€ 661,48
VAM14G	14,0 Gpl	€ 661,48



SCALDABAGNI CAMERA STAGNA **turboMAG plus low Nox**

Codice	RIFERIMENTI	Listino
VTM12M	12,0 Met	€ 946,39
VTM12G	12,0 Gpl	€ 946,39
VTM15M	15,0 Met	€ 1.083,37
VTM15G	15,0 Gpl	€ 1.083,37
VOM17M	17,0 Met	€ 1.035,77
VOM17G	17,0 Gpl	€ 1.035,77



I climaVAIR VAI plus di Vaillant sono la nuova generazione di climatizzatori pensati per regalarti un comfort che dura da mattina a sera.



Più Raee

Codice	Potenza	Listino
VAI8-025WN	9000 BTU	€ 750,29
VAI8-035WN	12000 BTU	€ 841,96
VAI8-050WN	18000 BTU	€ 1.262,39
VAI8-065WN	24000 BTU	€ 1.790,18

CLIMATIZZATORE CONDIZIONATORE OLIMPIA SPLENDID NEXYA S4 E INVERTER



Più Raee

Codice	Potenza	Listino
NS409	9000 BTU	€ 627,42
NS412	12000 BTU	€ 694,65
NS418	18000 BTU	€ 1.154,00
NS424	24000 BTU	€ 1.434,12
B1016	KIT WIFI	€ 72,83



New ODU Appearance

Spazio extra
per il filtro
della lavaggio



AUX
AIR CONDITIONER



Più Raee

CODICE	RIFERIMENTI	LISTINO
ASW-H09A4-FHR3D	BTU 9000	€ 558,00
ASW-H12A4-FHR3D	BTU 12000	€ 621,10
ASW-H18A4-FHR3D	BTU 18000	€ 1.090,64
ASW-H24A4-FHR3D	BTU 24000	€ 1.420,36



Barriere d'aria
a temperatura ambiente
con telecomando



Flusso d'aria orientabile

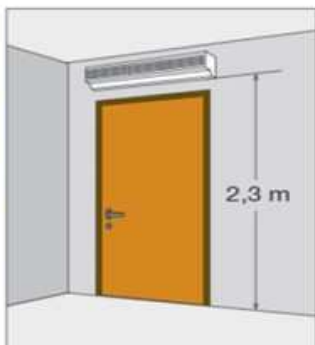

Installazione a 2,3 m minimo da terra



Diagramma della velocità dell'aria

Barriera		
Codice	Modello	Listino
OIB601	cm.60	€ 268,70
OIB901	cm.90	€ 292,60
OIB1201	cm.120	€ 346,30
OIB1501	cm.150	€ 498,55

MSZ-HR

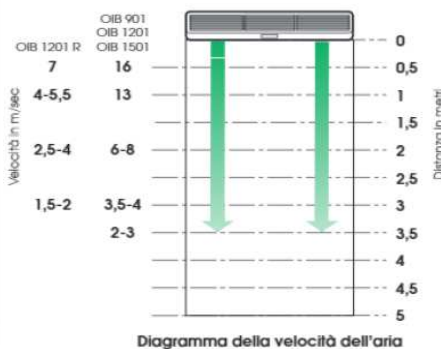

SERIE M - UNITÀ A PARETE - DC Inverter/Pompa di calore



Monosplit		
Codice	RIFERIMENTI	Listino
HR25VF	9000 BTU	€ 1.011,20
HR35VF	12000 BTU	€ 1.209,31
HR42VF	15000 BTU	€ 1.573,94

Più Raee



Split a Parete Inverter SYSPLIT WALL PRIME 09-24

Caratteristiche

SYSPLIT WALL PRIME rappresenta la soluzione più conveniente e affidabile per piccoli uffici e locali residenziali.

Il controllo DC inverter ad alta efficienza fornisce una regolazione accurata della temperatura nella stanza.

Aspetto elegante con display a scomparsa.

Connessione per modulo Wifi (opzionale).

Le unità esterne sono dotate di copertura di protezione dei rubinetti del refrigerante.

La funzione di auto-diagnosi verifica in maniera continua il funzionamento del climatizzatore d'aria e protegge il sistema.

Il rilevamento di perdite di refrigerante consente di evitare che il compressore venga danneggiato da perdite di refrigerante o da un sovraccarico del compressore stesso.

Il filtro cold catalyst decompone efficacemente composti volatili ed ha un effetto antibatterico. E' lavabile e mantiene l'effetto per molto tempo.

Grazie alla modalità Turbo l'unità funziona con velocità ultra per 20 minuti per raggiungere più velocemente la temperatura impostata.

Refrigerante R32 a basso GWP.



Comando remoto a infrarossi
SYS RM 57
(standard)



Modulo Wifi
SYSPLIT WIFI MODULE
Art. 315152
(opzionale)

La speciale funzione antigelo in modalità riscaldamento permette di mantenere una temperatura costante di 8°C durante periodi di assenza dell'utente.

Grazie alla funzione Riavvio Automatico l'unità si riavvia con le stesse impostazioni previste prima dell'interruzione di corrente.

Comando remoto a infrarossi SYS RM 57 incluso.

Dimensioni

SYSPLIT WALL PRIME

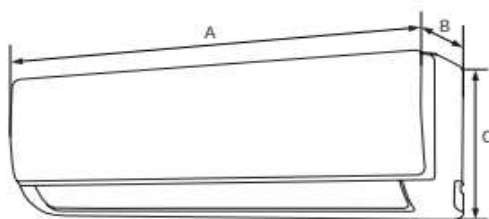

Modello	09	12	18	24
A	805	805	957	1.040
B	194	194	213	220
C	285	285	302	327

SYSPLIT WALL OUT

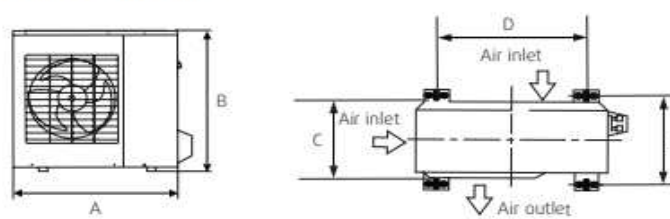

Modello	09	12	18	24
A	700	700	800	845
B	550	550	554	702
C	275	275	333	363
D	487	487	514	540
E	298	298	340	350

Split a Parete Inverter SYSPLIT WALL PRIME 09-24

Codice	BTU.	Unità Int.	Unità Est.	Listino
SYP9000	9000	315750	315809	€ 580,32
SYP12000	12000	315806	315810	€ 638,35

Catalogo Elettronico off-Line

La Fcdistribution mette a disposizione a tutti i clienti che ne faranno richiesta la possibilità di un programma off-line che permetterà a tutti i clienti di effettuare ordini fare preventivi ai loro clienti, senza bisogno di caricare gli articoli nel loro gestionale. Il programma può essere scaricato direttamente da un nostro operatore, oppure richiederlo anche in via remota alla nostra amministrazione (bisogna avere un pc la connessione ad internet e un programmino scaricabile in forma gratuita Es. TeamWiever. Le condizioni per usare questo programmino e di avere un pc excel. Una volta caricato il programma avete la possibilità di aggiornarlo ogni lunedì, permettendovi di visualizzare il nostro magazzino sia nelle giacenze che nella merce in arrivo. Con questo sistema che sta avendo un notevole successo presso i clienti vi permette di vendere molti articoli appoggiandovi alla nostra piattaforma.

Buon Lavoro



www.fcdistribution.net
info@fcdistribution.net

**CERCA IL PUNTO VENDITA
PIU' VICINO A CASA TUA.
TROVERAI
PERSONALE SPECIALIZZATO
CHE TI POTRA' CONSIGLIARE
NEI TUOI ACQUISTI**



**VASTO ASSORTIMENTO CON PREZZI
IMBATTIBILI**