

PROFESSIONALITA' E QUALITA'



EVOKlimaTM

TECNOLOGIA - BENESSERE - RISPETTO PER L'AMBIENTE

Edizione

12°

02/12/2024

www.evoklima.it

Smart Ingress

Ingresso intelligente



GUIDA AI PRODOTTI

WATER IS LIFE - L'ACQUA È VITA

L'IDRAULICA LA NOSTRA PASSIONE - HYDRAULICS OUR PASSION



YOUR SMART SOLUTION
GROHE
 CASSETTE PUCCI
LUBA
 SPHERA
 CAY
METAFORM™
GO PLAST
bonomini
ARTIPLASTIC™
astori
ATUSA
de pala
gebo
ICMA
EFFEBI
Geferplast s.r.l.
Conex | Bänninger
cewal
ARVEN RED LINE
ARVEN SUBMURGIBILE
ARVEN T-LINE
APM
Bandini
DIAMOND HOME
G.P.V. International
BRIXIA
calpeda
ZIPPONI
ARMANDO VICARIO
BST
FARIS
mm
idral
xylem
GOULDS
Bianchi GROUP
LUISE
AMS
elbi
COELBO
N.W.CO. INTERNATIONAL
IDRO-TEC
SIMBL
SMARTEC

REDI
Nicoll
SAB
L.B. PLAST
sime
OLIMPIA SPLENDID
sira industrie
IRSAP
lazzarini RADIATORI
BAXI
IMMERGAS
JUNKERS BOSCH

Rame Clima
armacell
DM
PROMO

Copriwater
PROMO

Platti Doccia
PROMO

Sanitari Civita
PROMO

Sanitari
PROMO

Tubi Pvc
PROMO

Cavidotto-Politilene
PROMO

Tubo Multistrato
PROMO

Presscontrol
PROMO

pressostato Square D
PROMO

Contatori
PROMO

Lowara
PROMO

Staffa lavabo
PROMO

Staffa lavabo
PROMO

Staffa lavabo
PROMO

Staffe Clima
PROMO

Rame Clima
PROMO

Igienizzante Inox
PROMO

Trattamento Aria
PROMO

Riscaldamento-Solare
PROMO

Scaldabagni
PROMO

Eco Pucci
PROMO

Placche Eco
PROMO

FC DISTRIBUTION

Whirlpool
Hotpoint ARISTON
Indesit
smeg
Tecnogas
Bompani
APELL
EISEI

GIO'STYLE
TERMOZETA
Ardes
POLYPOOL
BLACK&DECKER
Ariete
JOYCAR
bimar
stefanplast

beko
CANDY
Elettrodomestici Incasso
PROMO

Elettrodomestici Libera
PROMO

Trevida
PROMO

Vinco-Hunday
PROMO

Omac
PROMO

Latte Olio
PROMO

Stefanplast
PROMO

Plasticoforte
PROMO

Deposito - EvoKlima



Sala Meeting - Uffici



Scarica il foglio Excel Commissione



ENERGIE RINNOVABILI



SCOPRI LE SOLUZIONI



La nostra crescita si fonda sul rispetto e la fiducia di tutti i nostri collaboratori che danno ogni giorno un grande valore al nostro lavoro.



Tutto il nostro personale è attento a gestire in poco tempo i vostri ordini con precisione e puntualità. Il servizio di consegna è svolto da mezzi propri in maniera tempestiva e affidabile.



CONSEGNE IN 24/48 H

Novità cataloghi scaricabili QR. Con il nuovo sistema scaricabile Qr la Evoklima, potrà tenervi aggiornati quotidianamente. Scaricando il Pdf di vostro interesse avrete la possibilità di vedere tutti i prodotti della categoria e sottocategoria, la disponibilità, la merce in arrivo, il prezzo sarà da scontare (secondo le indicazioni fornite dal nostro Staff). Scaricatelo ogni qualvolta vi occorre della merce in modo di avere il pdf sempre aggiornato. il nostro staff avrà cura di tenere i pdf aggiornati.

N.B. Anche se vedete la disponibilità o merce in arrivo, richiedere la conferma dell'ordine per bloccare gli articoli di interesse. comprenderete essendo un sistema offline potrebbero arrivare più richieste contemporaneamente



Indice Catalogo 01 PROFESSIONALITA' E QUALITA' EVOKlima www.evoklima.it GUIDA AI PRODOTTI	02 Rame Catalogo 02	03 Collettori Catalogo 03	04 Valvole Catalogo 04	05 Multistrato Catalogo 05	06 Impianto Pavimento Catalogo 06	07 Raccordi Catalogo 07
08 Gas Catalogo 08	09 Polipropilene Catalogo 09 PROFESSIONALITA' E QUALITA' EVOKlima	10 Pvc Catalogo 10 Raccordi ARANCIO	11 Minuterie Catalogo 11	12 Polietilene & Raccordi Catalogo 12	13 Sebatoi per Alimenti Catalogo 13 SIMEL PROFESSIONALITA' E QUALITA' EVOKlima	14 Trattamento acque Catalogo 14 HYDRO MAX EVOKlima
15 Autoclave Catalogo 15	16 Pompe Arven Catalogo 16 Trattamento acque POMPE ARVEN	16 Pompe Calpeda Catalogo 16 calpeda	16 Pompe Lowara Catalogo 16 LOWARA a xylem brand	17 Antincendio Catalogo 17	18 Riscaldamento Catalogo 18	19 Radiatori Catalogo 19 ALLI nuovo sira ALLI nuovo IRSAP fondital
20 Fumisteria Catalogo 20	21 Caldaie Catalogo 21 BAXI	22 Stufe a Gas Catalogo 22 fondital	23 Accessori Clima Catalogo 23	24 Climatizzatori Catalogo 24	24 Olimpia Splendid Catalogo 24 OLIMPIA SPLENDID	25 Solare Catalogo 25 Oxone L'energia del sole
26 Scaldabagni Catalogo 26 ARISTON BAXI Bandini Vimar	34 Cassette Catalogo 27 SPHERA SPECIE A RILEVARE FRIGORIFERO DOCCIA VALVOLA RICCIA RISERVOIR EQUILIBRATO SOPRAPPORZIONE SACCHETTI DOCCIA RISERVOIR	34 Pucciplast Catalogo 28	34 Grohe Catalogo 29	34 Valsir Catalogo 30	35 Copriwater Catalogo 31	36 Accessori Bagno Catalogo 32
33 Import Catalogo 33	38 Box Doccia Catalogo 34 GRUPO GRUPO	39 Sanitari Catalogo 34 PICCO	40 Volantino Catalogo 34 LIBERTA' DI ESPRESSIONE CON UN UNICO PANNELLO ARRANGIAMO IL SPA	energie Rinnovabili Catalogo 34 valsir QUALITA' PER L'EDILIZIA TROPEA3 CASSETTE DI RISCIOLO	Commissione Excel Catalogo 35 Excel	
37 Lavanderia Mobili Catalogo 37 CIMA	38 Box Doccia Catalogo 38	39 Sanitari Catalogo 39	40 Volantino Volantino del Lunedì PROFESSIONALITA' E QUALITA' EVOKlima www.evoklima.it Smart Ingress Ingresso intelligente GUIDA AI PRODOTTI WATER IS LIFE - L'ACQUA È VITA L'ENERGIA LA NOSTRA PASSIONE - INTEGRALMENTE OUR PASSION	energie Rinnovabili Catalogo 37 EVOKlima I PROFESSIONISTI DEL SETTORE PRESENTANO CLIMA TECNOLOGIA EVOKlima	Commissione Excel Catalogo 37 Excel	
FC Distribution Tutto alla Portata Di Tutti www.fcdistribution.net ELETTRODOMESTICI PICCOLI ELETTRODOMESTICI Elettrodomestici Piccoli Elettrodomestici Ingresso & Libera Installazione	40 Volantino Catalogo 41 Elettrodomestici Ingresso & Libera Installazione	40 Volantino Catalogo 42 Piccoli Elettrodomestici	40 Volantino Catalogo 43 Riscaldatori Copriwater	Collection Elegance Catalogo 44 Mobili & Lavanderia	Catálogo 40 Caldaie Scaldabagni Climatizzatori	
Casalingo e contento Catalogo 46	40 Volantino Catalogo 47 Barbecue	40 Volantino Catalogo 48 Arredamento Avanti Piatto Verde	40 Volantino Catalogo 49 Barbecue	VOLANTINO Elettrodomestici L'OUTLET del KASALINGO	VOLANTINO Elettrodomestici L'OUTLET del KASALINGO	VOLANTINO Elettrodomestici L'OUTLET del KASALINGO



La **Evoklima** vi presenta il nuovo catalogo con Pdf interattivo. Potete scaricarlo dal sito www.evoklima.it oppure dalla piattaforma B2B www.edcrsr.it

Scaricate il catalogo in pdf frequentemente per non perdere gli aggiornamenti. A Pag. 04 troverete tutte le categorie semplicemente cliccando nell'immagine potrete ottenere il pdf della categoria con disponibilità e prezzo.

Mentre in moltissimi articoli sempre cliccando nell'immagine potrete scaricare le schede tecniche dell'articolo di interesse, Rapido, Veloce "Smart Ingress"

Tubi & Raccordi Pvc Pag. 06 	Raccordi PVC Pag. 08 	Raccordi Pvc Redi Pag. 09 	Tubi & Raccordi PHP Pag. 10 
Politilene & cavidotto Pag. 12 	Raccordi Politilene Pag. 13 	Valvolame Pag. 16 	Gas & Accessori Pag. 18 
Multistrato Pag. 22 	Raccordi Zincati Pag. 24 	Autoclave Pag. 38 	Pompe Calpeda Pag. 42 
Pompe Lowara Pag. 43 	Rubinetti Pag. 46 	Minuterie Pag. 80 	Saliscendi - Doccia Pag. 62 
Copriwater Pag. 70 	Sifoni Pag. 76 	Canalina Pag. 98 	Cassette Pag. 87 
Riscaldamento Pag. 102 	Cassette Grohe Pag. 95 	Solare Pag. 105 	Clima Pag. 100 
Scaldabagno Pag. 108 	Radiatori Pag. 104 	Elettrodomestici Pag. 128 	Fumisteria Pag. 107 
Giardino Pag. 114 	Attrezzi Pag. 110 	Barbecue Pag. 112 	Mobili Bagno Pag. 121 
Lavanderia Pag. 124 	Edilizia Pag. 118 	Box Doccia Pag. 130 	Sanitari & Piatti Doccia Pag. 132 



PVC tubi

PROMO

Tubo 1 mt



Tubo 2 mt



Tubo 3 mt



Codice	Rif.	Listino A	Listino B	Codice	Rif.	Listino A	Listino B	Codice	Rif.	Listino A	Listino B
T32X1	32x1	3,01 €	3,19 €	T32X2	32x2	5,18 €	5,49 €	T32X3	32x3	6,21 €	6,58 €
T40X1	40x1	3,01 €	3,19 €	T40X2	40x2	5,18 €	5,49 €	T40X3	40x3	6,21 €	6,58 €
T50X1	50x1	3,84 €	4,07 €	T50X2	50x2	6,58 €	6,98 €	T50X3	50x3	7,92 €	8,39 €
T63X1	63x1	4,88 €	5,17 €	T63X2	63x2	8,42 €	8,92 €	T63X3	63x3	10,09 €	10,69 €
T80X1	80x1	5,65 €	5,99 €	T80X2	80x2	9,72 €	10,31 €	T80X3	80x3	11,69 €	12,39 €
T100X1	100x1	5,98 €	6,34 €	T100X2	100x2	10,32 €	10,94 €	T100X3	100x3	12,36 €	13,10 €
T125X1	125x1	8,22 €	8,71 €	T125X2	125x2	14,16 €	15,01 €	T125X3	125x3	17,03 €	18,06 €
T140X1	140x1	9,89 €	10,48 €	T140X2	140x2	17,03 €	18,06 €	T140X3	140x3	20,42 €	21,65 €
T160X1	160x1	11,76 €	12,46 €	T160X2	160x2	20,31 €	21,52 €	T160X3	160x3	24,35 €	25,81 €
T200X1	200x1	16,63 €	17,63 €	T200X2	200x2	28,63 €	30,34 €	T200X3	200x3	34,37 €	36,43 €

Raccordi in PVC



Curva Chiusa solo a Confezione



Curva Aperta solo a Confezione



Braga a "V" solo a Confezione

Codice	Rif.	Listino A	Listino B	Codice	Rif.	Listino A	Listino B	Codice	Rif.	Listino A	Listino B
CC32	D. 32	0,53 €	0,57 €	CA32	D. 32	0,44 €	0,47 €	BV32	D. 32	0,80 €	0,85 €
CC40	D. 40	0,62 €	0,66 €	CA40	D. 40	0,53 €	0,57 €	BV40	D. 40	0,89 €	0,94 €
CC50	D. 50	0,89 €	0,94 €	CA50	D. 50	0,80 €	0,85 €	BV50	D. 50	1,16 €	1,23 €
CC63	D. 63	1,33 €	1,41 €	CA63	D. 63	1,25 €	1,32 €	BV63	D. 63	2,22 €	2,36 €
CC80	D. 80	1,69 €	1,79 €	CA80	D. 80	1,51 €	1,60 €	BV80	D. 80	3,20 €	3,39 €
CC100	D. 100	1,96 €	2,07 €	CA100	D. 100	1,69 €	1,79 €	BV100	D. 100	3,56 €	3,77 €
CC125	D. 125	3,11 €	3,30 €	CA125	D. 125	2,67 €	2,83 €	BV125	D. 125	6,23 €	6,60 €
CC140	D. 140	4,89 €	5,19 €	CA140	D. 140	4,00 €	4,24 €	BV140	D. 140	8,45 €	8,96 €
CC160	D. 160	5,78 €	6,13 €	CA160	D. 160	5,34 €	5,66 €	BV160	D. 160	10,67 €	11,31 €
CC200	D. 200	10,67 €	11,31 €	CA200	D. 200	8,89 €	9,43 €	BV200	D. 200	21,34 €	22,63 €

Tappo Cieco



Tappo con tre fori 100-40-40-40



Sifone a Colonna



Codice	Rif.	Listino A	Listino B	Codice	Rif.	Listino A	Listino B	Codice	Rif.	Listino A	Listino B
TFS32	32x1	0,56 €	0,59 €	TA100TF40	D. 100	3,54 €	3,75 €	SVM80	D. 80	18,72 €	19,85 €
TFS40	40x1	0,27 €	0,28 €					SVM100	D. 100	22,72 €	24,08 €
TFS50	50x1	0,36 €	0,38 €					SVM125	D. 125	31,63 €	33,53 €



Braga a "T" Ridotta

Codice	Rif.	Listino A	Listino B
BTR100X40	100x40	3,11 €	3,30 €
BTR100X50	100x50	3,11 €	3,30 €
BTR100X63	100x63	3,11 €	3,30 €
BTR100X80	100x80	3,11 €	3,30 €
BTR125X40	125x40	7,11 €	7,54 €
BTR125X50	125x50	7,11 €	7,54 €
BTR125X63	125x63	7,11 €	7,54 €
BTR125X80	125x80	7,11 €	7,54 €
BTR125X100	125x100	7,11 €	7,54 €



Braga a "V" Ridotta

Codice	Rif.	Listino A	Listino B
BVR100X40	100x40	3,11 €	3,30 €
BVR100X50	100x50	3,11 €	3,30 €
BVR100X63	100x63	3,11 €	3,30 €
BVR100X80	100x80	3,11 €	3,30 €
BVR125X40	125x40	7,11 €	7,54 €
BVR125X50	125x50	7,11 €	7,54 €
BVR125X63	125x63	7,11 €	7,54 €
BVR125X80	125x80	7,11 €	7,54 €
BVR125X100	125x100	7,11 €	7,54 €



Braga a "T" solo a Confezione

Codice	Rif.	Listino A	Listino B
BT32	D. 32	0,80 €	0,85 €
BT40	D. 40	0,89 €	0,94 €
BT50	D. 50	1,16 €	1,23 €
BT63	D. 63	2,22 €	2,36 €
BT80	D. 80	3,20 €	3,39 €
BT100	D. 100	3,56 €	3,77 €
BT125	D. 125	6,23 €	6,60 €
BT140	D. 140	8,45 €	8,96 €
BT160	D. 160	10,67 €	11,31 €
BT200	D. 200	21,34 €	22,63 €



Riduzione FM

Codice	Rif.	Listino A	Listino B
R40X32	40x32	0,53 €	0,57 €
R50X40	50x40	0,71 €	0,75 €
R63X40	63x40	0,76 €	0,80 €
R80X63	80x63	1,07 €	1,13 €
R80X40	80x40	1,07 €	1,13 €
R100X80	100x80	1,33 €	1,41 €
R100X63	100x63	1,33 €	1,41 €
R100X40	100x40	1,40 €	1,49 €
R125X100	125x100	2,22 €	2,36 €
R140X100	140x100	2,30 €	2,44 €
R140X125	140x125	3,11 €	3,30 €
R160X140	160x140	4,00 €	4,24 €
R200X160	200x160	6,23 €	6,60 €



Aumento MF

Codice	Rif.	Listino A	Listino B
A32X40	40x32	0,44 €	0,47 €
A40X50	50x40	0,71 €	0,75 €
A40X63	63x40	0,76 €	0,80 €
A40X80	80x40	1,07 €	1,13 €
A40X100	100x40	1,33 €	1,41 €
A63X80	80x63	1,07 €	1,13 €
A63X100	100x63	1,33 €	1,41 €
A80X100	100x80	1,33 €	1,41 €
A100X125	125x100	2,22 €	2,36 €
A100X140	140x100	3,11 €	3,30 €
A125X140	140x125	3,11 €	3,30 €
A140X160	160x140	4,00 €	4,24 €
A160X200	200x160	6,23 €	6,60 €



Tappo a Vite

Codice	Rif.	Listino A	Listino B
TV32	D. 32	2,54 €	2,69 €
TV40	D. 40	0,81 €	0,86 €
TV50	D. 50	1,60 €	1,70 €
TV63	D. 63	2,04 €	2,17 €
TV80	D. 80	2,22 €	2,36 €
TV100	D. 100	2,67 €	2,83 €
TV125	D. 125	3,56 €	3,77 €
TV140	D. 140	5,78 €	6,13 €
TV160	D. 160	7,74 €	8,20 €
TV200	D. 200	10,22 €	10,84 €



Valvola Antiriflusso

Codice	Rif.	Listino A	Listino B
VA100	D. 100	66,70 €	70,70 €
VA125	D. 125	75,60 €	80,13 €
VA140	D. 140	80,04 €	84,84 €
VA160	D. 160	124,51 €	131,98 €
VA200	D. 200	142,30 €	150,84 €



Sifone O-O

Codice	Rif.	Listino A	Listino B
SOO100	D. 100	13,34 €	14,14 €
SOO125	D. 125	17,79 €	18,85 €



Sifone Verticale

Codice	Rif.	Listino A	Listino B
SVO100	D. 100	17,79 €	18,85 €
SVO125	D. 125	22,23 €	23,57 €

Valvola Antiriflusso
Bianca 40X40



Codice	Rif.	Listino A	Listino B
0750AR64B0	40x40	12,07 €	12,79 €
0750AR54B0	32x32	12,95 €	13,73 €



Giunto Riparazione

Codice	Rif.	Listino A	Listino B
GR100	D. 100	7,11 €	7,54 €
GR125	D. 125	10,67 €	11,31 €



Giunto scorrevole

Codice	Rif.	Listino A	Listino B
GS80	D. 80	6,23 €	6,60 €
GS100	D. 100	7,11 €	7,54 €
GS125	D. 125	10,67 €	11,31 €



Braga a "V" Doppia

Codice	Rif.	Listino A	Listino B
BVD100	D. 100	10,67 €	11,31 €
BVD125	D. 125	16,01 €	16,97 €



Colla Riempitiva Pantakol

Codice	Rif.	Listino A	Listino B
TCRP	gr. 125	3,10 €	3,29 €
TCRPX200	x 200 Pz	2,79 €	2,96 €
TCRPX500	x 500 Pz	2,48 €	2,75 €



Colla Riempitiva

Codice	Rif.	Listino A	Listino B
BCRP	gr. 500	9,87 €	10,96 €
BCRP700	gr. 700	12,96 €	14,38 €



Bocchettone Terrazzo PVC

Codice	Rif.	Listino A	Listino B
BPA100	D. 100	8,82 €	8,82 €
BPA125	D. 125	18,28 €	18,28 €
BP100	D. 100	8,82 €	8,82 €
BP125	D. 125	9,80 €	9,80 €



Braga a "V" Scagno

Codice	Rif.	Listino A	Listino B
BVS100	D. 100	18,31 €	20,32 €
BVS125	D. 125	27,33 €	30,33 €



Pozzetto con coperchio 20x20

Codice	Rif.	Listino A	Listino B
PUC20PP	20x20	4,39 €	4,87 €

Pozzetto con coperchio 30x30

Codice	Rif.	Listino A	Listino B
PUC30PP	30x30	10,63 €	11,80 €

Pozzetto con coperchio 40x40

Codice	Rif.	Listino A	Listino B
PUC40PP	40x40	21,76 €	24,15 €



Telaio & Coperchio con Chiusino

Codice	Rif.	Listino A	Listino B
TC30S	30x30	13,76 €	15,28 €
TC40S	40x40	21,51 €	23,87 €
TC55S	55x55	77,42 €	85,94 €



Telaio & Coperchio con griglia

Codice	Rif.	Listino A	Listino B
UTG20PP	200X200	3,44 €	3,82 €
UTG30PP	300X300	6,88 €	7,64 €
UTG40PP	400X400	13,76 €	15,28 €
UTG55PP	550X550	32,69 €	36,29 €

Chiusino Laterale



Codice	Rif.	Listino A	Listino B
UTC20PP	200X200	3,44 €	3,82 €
UTC30PP	300X300	6,88 €	7,64 €
UTC40PP	400X400	13,76 €	15,28 €
UTC55PP	550X550	32,69 €	36,29 €



Collare per Pluviale

Codice	Rif.	Listino A	Listino B
CL32	D. 32	0,55 €	0,61 €
CL40	D. 40	0,76 €	0,84 €
CL50	D. 50	0,70 €	0,77 €
CL60	D. 63	0,84 €	0,93 €
CL80	D. 80	0,84 €	0,93 €
CL100	D. 100	0,87 €	0,97 €
CL125	D. 125	0,96 €	1,06 €
CL140	D. 140	0,89 €	0,98 €
CL160	D. 160	0,96 €	1,07 €
CL200	D. 200	4,07 €	4,52 €

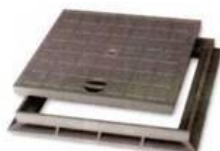

Telaio Con Coperchio



Chiusino

Codice	Rif.	Listino A	Listino B
CHRLQ	Grigio	3,74 €	4,16 €
CHRLQCRO	Cromo	9,36 €	10,39 €

Codice	Rif.	Listino A	Listino B
CS10PP	10X10	1,41 €	1,57 €
CS15PP	15X15	2,25 €	2,50 €



REDI
le strade dell'acqua

Curva Chiusa solo a Confezione

Codice	Rif.	Listino A	Listino B
CC32R	D. 32	1,04 €	1,15 €
CC40R	D. 40	0,77 €	0,86 €
CC50R	D. 50	Arrivo	Arrivo
CC63R	D. 63	Arrivo	Arrivo
CC80R	D. 80	Arrivo	Arrivo
CC100R	D. 100	2,42 €	2,68 €
CC125R	D. 125	Arrivo	Arrivo
CC140R	D. 140	Arrivo	Arrivo
CC160R	D. 160	Arrivo	Arrivo
CC200R	D. 200	Arrivo	Arrivo



REDI
le strade dell'acqua

Curva Aperta solo a Confezione

Codice	Rif.	Listino A	Listino B
CA32R	D. 32	1,14 €	1,26 €
CA40R	D. 40	0,84 €	0,93 €
CA50R	D. 50	Arrivo	Arrivo
CA63R	D. 63	Arrivo	Arrivo
CA80R	D. 80	Arrivo	Arrivo
CA100R	D. 100	2,10 €	2,33 €
CA125R	D. 125	Arrivo	Arrivo
CA140R	D. 140	Arrivo	Arrivo
CA160R	D. 160	Arrivo	Arrivo
CA200R	D. 200	Arrivo	Arrivo



REDI
le strade dell'acqua

Braga a "V" solo a Confezione

Codice	Rif.	Listino A	Listino B
BV32R	D. 32	Arrivo	Arrivo
BV40R	D. 40	Arrivo	Arrivo
BV50R	D. 50	Arrivo	Arrivo
BV63R	D. 63	Arrivo	Arrivo
BV80R	D. 80	Arrivo	Arrivo
BV100R	D. 100	4,48 €	4,98 €
BV125R	D. 125	Arrivo	Arrivo
BV140R	D. 140	Arrivo	Arrivo
BV160R	D. 160	Arrivo	Arrivo
BV200R	D. 200	Arrivo	Arrivo



REDI
le strade dell'acqua

Riduzione FM

Codice	Rif.	Listino A	Listino B
R40X32R	40x32	Arrivo	Arrivo
R50X40R	50x40	Arrivo	Arrivo
R63X40R	63x40	Arrivo	Arrivo
R80X63R	80x63	Arrivo	Arrivo
R80X40R	80x40	Arrivo	Arrivo
R100X80R	100x80	Arrivo	Arrivo
R100X63R	100x63	Arrivo	Arrivo
R100X40R	100x40	Arrivo	Arrivo
R125X100R	125x100	Arrivo	Arrivo
R140X100R	140x100	Arrivo	Arrivo
R140X125R	140x125	Arrivo	Arrivo
R160X140R	160x140	Arrivo	Arrivo
R200X160R	200x160	Arrivo	Arrivo



REDI
le strade dell'acqua

Aumento MF

Codice	Rif.	Listino A	Listino B
A32X40R	40x32	Arrivo	Arrivo
A40X50R	50x40	Arrivo	Arrivo
A40X63R	63x40	Arrivo	Arrivo
A40X80R	80x40	Arrivo	Arrivo
A40X100R	100x40	Arrivo	Arrivo
A63X80R	80x63	Arrivo	Arrivo
A63X100R	100x63	Arrivo	Arrivo
A80X100R	100x80	Arrivo	Arrivo
A100X125R	125x100	5,34 €	5,93 €
A100X140R	140x100	Arrivo	Arrivo
A125X140R	140x125	Arrivo	Arrivo
A140X160R	160x140	Arrivo	Arrivo
A160X200R	200x160	Arrivo	Arrivo



REDI
le strade dell'acqua

Braga a "T" solo a Confezione

Codice	Rif.	Listino A	Listino B
BT32R	D. 32	Arrivo	Arrivo
BT40R	D. 40	Arrivo	Arrivo
BT50R	D. 50	Arrivo	Arrivo
BT63R	D. 63	Arrivo	Arrivo
BT80R	D. 80	Arrivo	Arrivo
BT100R	D. 100	4,48 €	4,98 €
BT125R	D. 125	Arrivo	Arrivo
BT140R	D. 140	Arrivo	Arrivo
BT160R	D. 160	Arrivo	Arrivo
BT200R	D. 200	Arrivo	Arrivo



REDI
le strade dell'acqua

Tappo a Vite

Codice	Rif.	Listino A	Listino B
TV32R	D. 32	2,54 €	2,81 €
TV40R	D. 40	2,54 €	2,81 €
TV50R	D. 50	Arrivo	Arrivo
TV63R	D. 63	Arrivo	Arrivo
TV80R	D. 80	Arrivo	Arrivo
TV100R	D. 100	Arrivo	Arrivo



REDI
le strade dell'acqua

Sifone Verticale

Codice	Rif.	Listino A	Listino B
SVO100R	D. 100	Arrivo	Arrivo
SVO125R	D. 125	Arrivo	Arrivo



REDI
le strade dell'acqua

Sifone O-O

Codice	Rif.	Listino A	Listino B
SOO100R	D. 100	26,72 €	29,66 €
SOO125R	D. 125	Arrivo	Arrivo



Tubo in PP 2 Bicchieri



Codice	Riferimenti	Pz	Listino A	Listino B
VS0501201	cm. 50D. 32	1	2,65 €	2,94 €
VS0501203	MT. 1,00D. 32	1	3,48 €	3,87 €
VS0501205	MT. 2,00D. 32	1	6,41 €	7,12 €
VS0501207	MT. 3,00D. 32	1	8,73 €	9,69 €
VS0501213	cm. 50D. 40	1	2,12 €	2,35 €
VS0501215	MT. 1,00D. 40	1	3,12 €	3,46 €
VS0501217	MT. 2,00D. 40	1	5,48 €	6,08 €
VS0501219	MT. 3,00D. 40	1	8,22 €	9,13 €
VS0501225	cm. 50D. 50	1	2,65 €	2,94 €
VS0501227	MT. 1,00D. 50	1	3,81 €	4,23 €
VS0501229	MT. 2,00D. 50	1	7,29 €	8,10 €
VS0501231	MT. 3,00D. 50	1	10,87 €	12,07 €
VS0501281	cm. 50D. 90	1	6,60 €	7,32 €
VS0501283	MT. 1,00D. 90	1	9,85 €	10,93 €
VS0501285	MT. 2,00D. 90	1	17,47 €	19,39 €
VS0501287	MT. 3,00D. 90	1	26,11 €	28,98 €
VS0501249	cm. 50D. 110	1	7,90 €	8,77 €
VS0501251	MT. 1,00D. 110	1	11,23 €	12,47 €
VS0501253	MT. 2,00D. 110	1	20,81 €	23,10 €
VS0501255	MT. 3,00D. 110	1	30,10 €	33,41 €

Tubo in PP 1 Bicchiere



Codice	Riferimenti	Pz	Listino A	Listino B
VS0501005	cm. 50D. 32	1	1,90 €	2,11 €
VS0501009	MT. 1,00D. 32	1	3,02 €	3,35 €
VS0501013	MT. 2,00D. 32	1	5,67 €	6,29 €
VS0501015	MT. 3,00D. 32	1	8,36 €	9,28 €
VS0501025	cm. 50D. 40	1	1,75 €	1,94 €
VS0501029	MT. 1,00D. 40	1	2,67 €	2,96 €
VS0501033	MT. 2,00D. 40	1	5,16 €	5,72 €
VS0501035	MT. 3,00D. 40	1	7,57 €	8,40 €
VS0501045	cm. 50D. 50	1	2,12 €	2,35 €
VS0501049	MT. 1,00D. 50	1	3,39 €	3,76 €
VS0501053	MT. 2,00D. 50	1	6,50 €	7,22 €
VS0501055	MT. 3,00D. 50	1	9,48 €	10,52 €
VS0501145	cm. 50D. 90	1	5,39 €	5,98 €
VS0501149	MT. 1,00D. 90	1	8,64 €	9,59 €
VS0501153	MT. 2,00D. 90	1	16,45 €	18,26 €
VS0501155	MT. 3,00D. 90	1	24,99 €	27,74 €
VS0501085	cm. 50D. 110	1	6,13 €	6,81 €
VS0501089	MT. 1,00D. 110	1	9,48 €	10,52 €
VS0501093	MT. 2,00D. 110	1	18,39 €	20,42 €
VS0501095	MT. 3,00D. 110	1	27,87 €	30,94 €

Braga Semplice a 45° in PP



Codice	Riferimenti	Pz	Listino A	Listino B
VS0508001	D. 32	1	2,18 €	2,42 €
VS0508007	D. 40	1	1,60 €	1,77 €
VS0508013	D. 50	1	2,02 €	2,25 €
VS0599061	D. 90	1	5,48 €	6,08 €
VS0508025	D. 110	1	5,39 €	5,98 €

Curva MF a 90° in PP



Codice	Riferimenti	Pz	Listino A	Listino B
VS0504011	D. 32	1	0,93 €	1,03 €
VS0504023	D. 40	1	0,82 €	0,91 €
VS0504035	D. 50	1	1,07 €	1,19 €
VS0599051	D. 90	1	2,79 €	3,09 €
VS0504059	D. 110	1	3,34 €	3,71 €

Braga Semplice a 90° in PP



Codice	Riferimenti	Pz	Listino A	Listino B
VS0508005	D. 32	1	2,23 €	2,48 €
VS0508011	D. 40	1	1,60 €	1,77 €
VS0508017	D. 50	1	2,09 €	2,32 €
VS0599065	D. 90	1	5,48 €	6,08 €
VS0508029	D. 110	1	5,39 €	5,98 €

Curva MF a 45° in PP



Codice	Riferimenti	Pz	Listino A	Listino B
VS0504005	D. 32	1	0,93 €	1,03 €
VS0504017	D. 40	1	0,82 €	0,91 €
VS0504029	D. 50	1	1,03 €	1,15 €
VS0599045	D. 90	1	2,79 €	3,09 €
VS0504053	D. 110	1	3,30 €	3,66 €



Braga Rid.Pp Htea D.90/40
90°

Codice	Riferimenti	Pz	Listino A	Listino B
VS0599075	D.90/40	1	3,63 €	4,03 €
VS0599077	D.90/50	1	5,47 €	6,07 €
VS0510029	D.110/40	1	3,74 €	4,16 €
VS0510035	D.110/50	1	3,67 €	4,07 €



Braga Rid.Pp Htea D.40/32
45°

Codice	Riferimenti	Pz	Listino A	Listino B
VS0510001	D.40/32	1	2,40 €	2,66 €
VS0599071	D.90/40	1	3,78 €	4,20 €
VS0599073	D.90/50	1	3,92 €	4,35 €
VS0510025	D.110/40	1	3,69 €	4,10 €
VS0599089	D.110/90	1	10,02 €	11,12 €
VS0510031	D.110/50	1	3,64 €	4,04 €



Pp Braga Doppia 110-110- 110-
67

Codice	Riferimenti	Pz	Listino A	Listino B
BDA111167	110-110-110	1	15,79 €	17,53 €



Pp Braga Doppia 90-90-90- 87°

Codice	Riferimenti	Pz	Listino A	Listino B
BDA090987	90-90-90	1	14,40 €	15,98 €



Sella Dm.100/40 Pvc Grigio

Codice	Riferimenti	Pz	Listino A	Listino B
SL104	100X40	1	5,55 €	6,16 €



Pvc Curva Ridotta 110-100- 87°

Codice	Riferimenti	Pz	Listino A	Listino B
BPV111087	110-110	1	8,45 €	9,38 €



Curve Tecniche ad incollaggio

Codice	Riferimenti	Pz	Listino A	Listino B
CR40X32FF	D. 40 F x 32 F	1	1,52 €	1,69 €
CR40X32FM	D. 40 F x 32 M	1	Arrivo	Arrivo
C40FF	D. 40 F x 40 F	1	1,86 €	2,06 €



Riduzione Ecc.Pp Htr D.
40/32



Codice	Riferimenti	Pz	Listino A	Listino B
VS0514001	A. . 40-32	1	1,37 €	1,53 €
VS0514002	A. . 50-32	1	1,61 €	1,78 €
VS0514003	A. . 50-40	1	0,94 €	1,04 €



Tronchetto per collegamento
Pvc

Codice	Riferimenti	Pz	Listino A	Listino B
VS0530001	D.40	1	3,34 €	3,71 €
VS0530003	D.50	1	3,81 €	4,23 €
VS0599121	D.90	1	8,60 €	9,55 €
VS0530007	D.110	1	7,06 €	7,84 €



Pp Curva Wc Prolung Dn 110-
90°

Codice	Riferimenti	Pz	Listino A	Listino B
BSBPR0090	110-90°	1	9,48 €	10,52 €
BSBPR0990	90°-90°	1	8,83 €	9,80 €



Pvc-Pp Racc Passagg Dn 100-
110

Codice	Riferimenti	Pz	Listino A	Listino B
BPV100110	110-110	1	5,11 €	5,67 €



Politilene D. 20 Pn 25 Ad
Pe100 Sdr 7,4



PROMO

Codice	Riferimenti	Mt	Listino A	Listino B
PN2025	D. 20-1/2"	200	1,87 €	1,99 €
PN2525	D. 25-3/4"	200	2,76 €	2,93 €
PN3225	D. 32-1"	200	3,09 €	3,28 €
PN4025	D. 40-11/4	100	4,83 €	5,12 €
PN5025	D. 50-11/2	100	7,53 €	7,98 €
PN6325	D. 63-2	50	Arrivo	Arrivo

Politilene Pe100 D. 20 Pn 16
Sdr11



PROMO

Codice	Riferimenti	Mt	Listino A	Listino B
PN2016	D. 20-1/2"	200	1,45 €	1,54 €
PN2516	D. 25-3/4"	200	1,42 €	1,51 €
PN3216	D. 32-1"	200	2,21 €	2,34 €
PN4016	D. 40-11/4	100	4,13 €	4,38 €
PN5016	D. 50-11/2	100	5,30 €	5,62 €
PN6316	D. 63-2	50	9,97 €	10,57 €

Politilene Bassa Densità Peld
D20 Pn10



PROMO

Codice	Riferimenti	Mt	Listino A	Listino B
PN2010	D. 20-1/2"	200	1,35 €	1,43 €
PN2510	D. 25-3/4"	200	1,97 €	2,09 €
PN3210	D. 32-1"	200	3,21 €	3,41 €
PN4010	D. 40-11/4	100	4,94 €	5,24 €
PN5010	D. 50-11/2	100	7,77 €	8,23 €
PN6310	D. 63-2	50	12,32 €	13,06 €

Politilene Irrigazione Pn 6
D.20 Bd



PROMO

Codice	Riferimenti	Mt	Listino A	Listino B
P620	D. 20-1/2"	200	0,95 €	1,01 €
P625	D. 25-3/4"	200	1,41 €	1,49 €
P632	D. 32-1"	200	2,30 €	2,43 €
P640	D. 40-11/4	100	3,52 €	3,73 €
P650	D. 50-11/2	100	5,36 €	5,68 €
P663	D. 63-2	50	8,43 €	9,36 €

Politilene Riplast Bassa
Densità
Linea Agricoltura Pn 10 D. 20



PROMO

Codice	Riferimenti	Mt	Listino A	Listino B
P20	D. 20-1/2"	200	0,73 €	0,78 €
P25	D. 25-3/4"	200	1,14 €	1,20 €
P32	D. 32-1"	200	1,85 €	1,96 €
P40	D. 40-11/4"	100	2,45 €	2,60 €
P50	D. 50-11/2	100	3,93 €	4,17 €
P63	D. 63-2	50	6,51 €	6,90 €

Tubi Corrugati In Hpde Cav 40



PROMO

Codice	Riferimenti	Mt	Listino A	Listino B
CAV40	D. 40	200	1,62 €	1,72 €
CAV50	D. 50	200	1,95 €	2,07 €
CAV63	D. 63	200	2,40 €	2,55 €

Politilene Gas S5 D. 20 Ad
Pe100

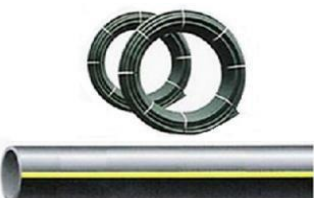

PROMO

Codice	Riferimenti	Mt	Listino A	Listino B
P20G	D. 20-1/2"	200	1,41 €	1,49 €
P25G	D. 25-3/4"	200	2,01 €	2,13 €
P32G	D. 32-1"	200	2,64 €	2,80 €
P40G	D. 40-11/4	100	3,57 €	3,78 €
P50G	D. 50-11/2	100	5,64 €	5,98 €
P63G	D. 63-2	50	8,87 €	9,41 €

HD-PE100 IMPACT PN25-
SDR 7,4 Tubo in rotoli per acqua.
Per il coinvolgimento in pressione di
acqua potabile e per applicazioni
industriali



PROMO

Codice	Riferimenti	Mt	Listino A	Listino B
PI2025	D. 20-1/2"	200	1,44 €	1,53 €
PI2525	D. 25-3/4"	200	2,12 €	2,25 €
PI3225	D. 32-1"	200	3,31 €	3,50 €
PI4025	D. 40-11/4	100	5,16 €	5,47 €
PI5025	D. 50-11/2	100	8,05 €	8,54 €
PI6325	D. 63-2	50	12,62 €	13,38 €



Nipples Maschio Politilene
D. 1/2" X 20

Codice	Riferimenti	Pz	Listino A	Listino B
NM20PB	1/2"x20	1	2,26 €	2,51 €
NM25PB	3/4"x25	1	3,66 €	4,06 €
NM32PB	1"x32	1	6,25 €	6,94 €
NM40PB	1 1/4"x40	1	10,68 €	11,86 €
NM50PB	1 1/2"x50	1	15,20 €	16,88 €
NM63PB	2"x63	1	24,20 €	26,86 €



Niples Femmina Politilene
D. 1/2" X 20

Codice	Riferimenti	Pz	Listino A	Listino B
NF20PB	1/2"x20	1	2,41 €	2,67 €
NF25PB	3/4"x25	1	3,54 €	3,93 €
NF32PB	1"x32	1	5,89 €	6,54 €
NF40PB	1 1/4"x40	1	10,46 €	11,61 €
NF50PB	1 1/2"x50	1	15,36 €	17,05 €
NF63PB	2"x63	1	23,61 €	26,20 €



Nipples Doppio Politilene
D. 20

Codice	Riferimenti	Pz	Listino A	Listino B
N20PB	20x20	1	3,66 €	4,06 €
N25PB	25x25	1	5,55 €	6,16 €
N32PB	32x32	1	9,35 €	10,38 €
N40PB	40x40	1	15,69 €	17,41 €
N50PB	50x50	1	23,92 €	26,55 €
N63PB	63x63	1	37,83 €	41,99 €



Gomito Doppio 20
Politilene

Codice	Riferimenti	Pz	Listino A	Listino B
G20PB	20x20	1	4,42 €	4,90 €
G25PB	25x25	1	6,36 €	7,06 €
G32PB	32x32	1	11,24 €	12,48 €
G40PB	40x40	1	18,46 €	20,49 €
G50PB	50x50	1	31,70 €	35,18 €
G63PB	63x63	1	50,84 €	56,43 €



Gomito Femmina Politilene
D. 1/2" X 20

Codice	Riferimenti	Pz	Listino A	Listino B
GF20PB	1/2"x20	1	3,26 €	3,62 €
GF25PB	3/4"x25	1	5,23 €	5,80 €
GF32PB	1"x32	1	7,72 €	8,56 €
GF40PB	1 1/4"x40	1	14,72 €	16,34 €
GF50PB	1 1/2"x50	1	24,89 €	27,63 €
GF63PB	2"x63	1	40,61 €	45,08 €



Gomito Maschio Politilene
D. 1/2" X 20

Codice	Riferimenti	Pz	Listino A	Listino B
GM20PB	1/2"x20	1	3,30 €	3,66 €
GM25PB	3/4"x25	1	5,16 €	5,73 €
GM32PB	1"x32	1	8,90 €	9,88 €
GM40PB	1 1/4"x40	1	15,94 €	17,69 €
GM50PB	1 1/2"x50	1	24,84 €	27,57 €
GM63PB	2"x63	1	39,12 €	43,42 €



Tee Politilene 3 Lati D. 20

Codice	Riferimenti	Pz	Listino A	Listino B
T20PB	20x20	1	6,08 €	6,75 €
T25PB	25x25	1	8,89 €	9,86 €
T32PB	32x32	1	15,91 €	17,66 €
T40PB	40x40	1	26,20 €	29,08 €
T50PB	50x50	1	40,42 €	44,87 €
T63PB	63x63	1	60,76 €	67,44 €



Tees Femmina Politilene
D. 1/2" X 20

Codice	Riferimenti	Pz	Listino A	Listino B
TF20PB	1/2"x20	1	4,90 €	5,43 €
TF25PB	3/4"x25	1	7,30 €	8,11 €
TF32PB	1"x32	1	11,92 €	13,23 €
TF40PB	1 1/4"x40	1	21,01 €	23,32 €
TF50PB	50x50	1	33,13 €	36,77 €
TF63PB	63x63	1	50,85 €	56,45 €



Gomito Femmina Flangiato
Politilene D. 1/2X20

Codice	Riferimenti	Pz	Listino A	Listino B
GFL20PB	1/2"x20	1	4,42 €	4,90 €
GFL25PB	3/4"x25	1	7,00 €	7,77 €

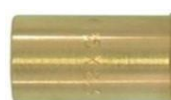

Anima Rinforzo Pol. 20

Codice	Riferimenti	Pz	Listino A	Listino B
A20PB	1/2"x20	1	1,18 €	1,31 €
A25PB	3/4"x25	1	1,69 €	1,87 €
A32PB	1"x32	1	3,32 €	3,69 €
A40PB	1 1/4"x40	1	3,60 €	3,99 €



Raccordo Compressione M
20X3/4"

Codice	Riferimenti	Listino A	Listino B	Off.	Box
330-G20	20x3/4"	0,82 €	0,91 €	1	12
330-G25	25x3/4"	1,05 €	1,17 €	1	12
330-H32	32x1"	1,08 €	1,20 €	1	12
330-HB40	40x11/4"	2,54 €	2,82 €	1	12
330-HD50	50x11/2"	3,09 €	3,44 €	1	12
330-OL63	2"	4,09 €	4,54 €	1	12



Raccordo Compressione F
20X1/2"

Codice	Riferimenti	Listino A	Listino B	Off.	Box
330A-D20	20x3/4"	1,59 €	1,77 €	1	12
330A-G25	25x3/4"	1,22 €	1,35 €	1	12
330A-H32	32x1"	1,23 €	1,37 €	1	12
330A-HB40	40x11/4"	2,24 €	2,49 €	1	12
330A-HD50	50x11/2"	3,51 €	3,89 €	1	12
330A-OL63	2"	4,09 €	4,54 €	1	12



Gomito Doppio 90° 25X25

Codice	Riferimenti	Listino A	Listino B	Off.	Box
332-20	D. 20	1,49 €	1,66 €	1	12
332-25	D. 25	1,62 €	1,79 €	1	12
332-32	D. 32	3,54 €	3,93 €	1	12
332-40	D. 40	4,61 €	5,11 €	1	12
332-50	D. 50	8,53 €	9,46 €	1	12
332-63	D. 63	7,51 €	8,34 €	1	12



Nipples Doppio 25X25

Codice	Riferimenti	Listino A	Listino B	Off.	Box
331-20	D. 20	1,32 €	1,47 €	1	12
331-25	D. 25	1,53 €	1,70 €	1	12
331-32	D. 32	1,96 €	2,17 €	1	12
331-40	D. 40	4,22 €	4,69 €	1	12
331-50	D. 50	4,81 €	5,34 €	1	12
331-63	D. 63	6,68 €	7,42 €	1	12



Tee 90° F 25X3/4"

Codice	Riferimenti	Listino A	Listino B	Off.	Box
333-D20	20x1/2"	1,47 €	1,63 €	1	12
333-G25	25x3/4"	1,88 €	2,09 €	1	12
333-H32	32x1"	2,96 €	3,29 €	1	12
333-HB40	40x11/4"	5,44 €	6,04 €	1	12
333-HD50	11/2"x50	6,48 €	7,19 €	1	12
333-OL63	2"x63	10,17 €	11,29 €	1	12



Tee 90° Tre Lati D. 25

Codice	Riferimenti	Listino A	Listino B	Off.	Box
334-20	D. 20	1,73 €	1,92 €	1	12
334-25	D. 25	2,30 €	2,55 €	1	12
334-32	D. 32	2,98 €	3,31 €	1	12
334-40	D. 40	5,19 €	5,76 €	1	12
334-50	D. 50	7,11 €	7,90 €	1	12
334-63	D. 63	10,10 €	11,21 €	1	12



Gomito 90° Maschio
3/4"X25

Codice	Riferimenti	Listino A	Listino B	Off.	Box
332A-D20	1/2"x20	1,06 €	1,18 €	1	12
332A-G25	3/4"x25	1,29 €	1,43 €	1	12
332A-H32	1"x32	1,59 €	1,77 €	1	12
332A-HB40	11/4"x40	2,66 €	2,95 €	1	12
332A-HD50	11/2"x50	3,69 €	4,10 €	1	12
332A-OL63	2"x63	4,88 €	5,42 €	1	12



Gomito Politilene F.
3/4"X25

Codice	Riferimenti	Listino A	Listino B	Off.	Box
332B-D20	1/2"x20	1,14 €	1,26 €	1	12
332B-G25	3/4"x25	1,25 €	1,38 €	1	12
332B-H32	1"x32	1,55 €	1,72 €	1	12
332B-HB40	11/4"x40	3,08 €	3,42 €	1	12
332B-HD50	11/2"x50	4,09 €	4,54 €	1	12
332B-OL63	2"x63	5,62 €	6,24 €	1	12



Gomito Flangia 3/4"X25

Codice	Riferimenti	Listino A	Listino B	Off.	Box
332D-D20	1/2"x20	3,01 €	3,34 €	1	12
332D-G25	3/4"x25	3,01 €	3,34 €	1	12



Tee 90° M 25X3/4"

Codice	Riferimenti	Listino A	Listino B	Off.	Box
333A-D20	1/2"x20	1,62 €	1,80 €	1	12
333A-G25	3/4"x25	2,05 €	2,27 €	1	12
333A-H32	1"x32	4,20 €	4,66 €	1	12
333A-HB40	11/4"x40	4,63 €	5,14 €	1	12
333A-HD50	11/2"x50	6,27 €	6,97 €	1	12
333A-OL63	2"x63	10,02 €	11,12 €	1	12



Art. 420



Tappo Calotta Femmina D. 3/4"

Codice	Riferimenti	Listino A	Listino B	Off.	Box
420-D	1/2"x20	0,18 €	0,20 €	1	12
420-G	3/4"x25	0,23 €	0,26 €	1	12
420-H	1"x32	0,34 €	0,37 €	1	12
420-HB	1 1/4"x40	0,55 €	0,61 €	1	12
420-HD	1 1/2"x50	0,81 €	0,90 €	1	12
420-OL	2"x63	1,01 €	1,12 €	1	12

Art. 460



Gomito Ff 90° D. 3/4"

Codice	Riferimenti	Listino A	Listino B	Off.	Box
460-D	1/2"x20	0,94 €	1,04 €	1	12
460-G	3/4"x25	1,10 €	1,22 €	1	12
460-H	1"x32	1,23 €	1,37 €	1	12
460-HB	1 1/4"x40	2,10 €	2,34 €	1	12
460-HD	1 1/2"x50	3,28 €	3,65 €	1	12
460-OL	2"x63	4,68 €	5,19 €	1	12

Art. 470



Tee Fff 90° D. 3/4"

Codice	Riferimenti	Listino A	Listino B	Off.	Box
470-D	1/2"x20	1,23 €	1,37 €	1	12
470-G	3/4"x25	1,51 €	1,68 €	1	12
470-H	1"x32	1,64 €	1,82 €	1	12
470-HB	1 1/4"x40	2,84 €	3,15 €	1	12
470-HD	1 1/2"x50	4,23 €	4,70 €	1	12
470-OL	2"x63	6,63 €	7,36 €	1	12

Art. 440



Manicotto Pvc Ff D. 3/4"

Codice	Riferimenti	Listino A	Listino B	Off.	Box
440-D	1/2"x20	0,49 €	0,55 €	1	12
440-G	3/4"x25	0,53 €	0,59 €	1	12
440-H	1"x32	0,66 €	0,73 €	1	12
440-HB	1 1/4"x40	1,49 €	1,65 €	1	12
440-HD	1 1/2"x50	2,17 €	2,41 €	1	12
440-OL	2"x63	2,60 €	2,89 €	1	12

Art. 400



Nipplo Pvc D. 1"

Codice	Riferimenti	Listino A	Listino B	Off.	Box
400-D	1/2"x20	0,19 €	0,21 €	10	120
400-G	3/4"x25	0,22 €	0,25 €	10	120
400-H	1"x32	0,33 €	0,36 €	5	60
400-HB	1 1/4"x40	0,57 €	0,64 €	5	40
400-HD	1 1/2"x50	0,78 €	0,87 €	5	40
400-OL	2"x63	1,23 €	1,37 €	5	20

Art. 430



Tappo Maschio Pvc D. 3/4"

Codice	Riferimenti	Listino A	Listino B	Off.	Box
430-D	1/2"x20	0,22 €	0,25 €	1	12
430-G	3/4"x25	0,31 €	0,34 €	1	12
430-H	1"x32	0,32 €	0,35 €	1	12
430-HB	1 1/4"x40	0,51 €	0,56 €	1	12
430-HD	1 1/2"x50	0,90 €	1,00 €	1	12
430-OL	2"x63	1,10 €	1,22 €	1	12

Art. 500



Gomito 90° Mf D. 3/4"

Codice	Riferimenti	Listino A	Listino B	Off.	Box
500-D	1/2"x20	0,81 €	0,90 €	1	12
500-G	3/4"x25	0,86 €	0,95 €	1	12
500-H	1"x32	1,04 €	1,15 €	1	12

VJB



Valvola A Sfera Pn16 D. 3/4" PI

Codice	Riferimenti	Listino A	Listino B	Off.	Box
VJB0152	1/2"x20	Arrivo	Arrivo	1	12
VJB0202	3/4"x25	2,28 €	2,53 €	1	12
VJB0252	1"x32	2,78 €	3,09 €	1	12
VJB0322	1 1/4"x40	5,06 €	5,62 €	1	12
VJB0402	1 1/2"x50	7,59 €	8,43 €	1	12
VJB0502	2"x63	11,64 €	12,92 €	1	12

Art. 480



Riduzione Pvc Mf 1"X1/2"

Codice	Riferimenti	Listino A	Listino B	Off.	Box
480-GD	3/4"X1/2"	0,43 €	0,48 €	1	12
480-HD	1"X1/2"	0,46 €	0,51 €	1	12
480-HG	1"X3/4"	0,47 €	0,52 €	1	12
480-HBD	1 1/4"X1/2"	0,69 €	0,77 €	1	12
480-HBG	1 1/4"X3/4"	0,69 €	0,77 €	1	12
480-HBH	1 1/4"X1"	0,78 €	0,87 €	1	12
480-HDG	1 1/2"X3/4"	1,22 €	1,35 €	1	12
480-HDH	1 1/2"X1"	1,22 €	1,35 €	1	12
480-HDHB	1 1/2"X1 1/4"	1,42 €	1,57 €	1	12
480-OLD	2"X1/2"	1,57 €	1,74 €	1	12
480-OLG	2"X3/4"	1,57 €	1,74 €	1	12
480-OLH	2"X1"	1,93 €	2,14 €	1	12
480-OLHB	2"X1 1/4"	3,97 €	4,41 €	1	12
480-OLHD	2"X1 1/2"	3,97 €	4,41 €	1	12
480-OLDOL	2 1/2"X2"	2,80 €	3,10 €	1	12
480-YOL	3"X2"	6,07 €	6,73 €	1	12
480-YOLD	3"X2 1/2"	6,07 €	6,73 €	1	12



Tubo Polipropilene 20X3,4
Fusiotherm Faser Sdr 6 / 7,4 S
Zz Barra 4 Mt Prezzo Metro

Codice	Riferimenti	Listino A	Listino B	Off.	Box
TA20X3,4	D.. 20	1,49 €	1,66 €	4	12
TA25X4,2	D.. 25	2,38 €	2,64 €	4	12
TA32X5,4	D.. 32	4,39 €	4,87 €	4	12
TA40X6,7	D.. 40	7,33 €	8,14 €	4	12



Tee Maschio Polipropilene
1/2X20

Codice	Riferimenti	Listino A	Listino B	Off.	Box
TMA1\2X20	1/2"x20	4,87 €	5,41 €	1	12
TMA3\4X25	3/4"x25	6,63 €	7,36 €	1	12



Gomito Filettato Maschio
1/2"X20

Codice	Riferimenti	Listino A	Listino B	Off.	Box
GAM1\2X20	1/2"x20	2,88 €	3,19 €	1	12
GAM3\4X20	3/4"x20	5,21 €	5,79 €	1	12
GAM1\2X25	1/2"X25	4,87 €	5,41 €	1	12
GAM3\4X25	3/4"X25	5,26 €	5,84 €	1	12
GAM3\4X32	3/4"X32	9,75 €	10,82 €	1	12
GAM1X32	1"X32	12,18 €	13,52 €	1	12



Gomito Fem. Polipropilene
1/2"X20

Codice	Riferimenti	Listino A	Listino B	Off.	Box
GFA1\2X20	1/2"x20	2,96 €	3,29 €	1	12
GFA3\4X20	3/4"x20	3,66 €	4,06 €	1	12
GFA3\4X25	3/4"x25	4,39 €	4,87 €	1	12
GFA3\4X32	3/4"X32	5,65 €	6,28 €	1	12
GFA1X32	1"X32	9,75 €	10,82 €	1	12



Tee Femmina Polipropilene
1/2X20

Codice	Riferimenti	Listino A	Listino B	Off.	Box
TFA1\2X20	1/2"x20	3,31 €	3,68 €	1	12
TFA3\4X25	3/4"x25	5,07 €	5,63 €	1	12
TFA3\4X32	3/4"X32	7,41 €	8,22 €	1	12
TFA1X32	1"X32	12,84 €	14,26 €	1	12



Raccordo Retto Con Dado
Girevole 3/4 F X 20

Codice	Riferimenti	Listino A	Listino B	Off.	Box
RRGA3\4X20	3/4"X20	10,23 €	11,36 €	1	12
RRGA1X32	1"X32	26,32 €	29,21 €	1	12
RRGA11\2X40	1"1/2X40	19,40 €	21,53 €	1	12
RRGA2X50	2"X50	43,22 €	47,98 €	1	12
RRGA21\2X63	21/2"X63	60,99 €	67,70 €	1	12



Nipples Maschio Polipropilene
D.1/2"X20

Codice	Riferimenti	Listino A	Listino B	Off.	Box
NMA1\2X20	1/2"x20	3,02 €	3,35 €	1	12
NMA1\2X25	1/2"x25	4,68 €	5,19 €	1	12
NMA3\4X20	3/4"x20	4,97 €	5,52 €	1	12
NMA3\4X25	3/4"x25	4,87 €	5,41 €	1	12
NMA11\4X40	11/4"x40	21,44 €	23,80 €	1	12
NMA11\2X50	11/2"x50	24,86 €	27,59 €	1	12
NMA2X63	2"x63	38,50 €	42,74 €	1	12



Nipples Femmina Polipropilene
D.1/2"X20

Codice	Riferimenti	Listino A	Listino B	Off.	Box
NFA1\2X20	1/2"x20	2,63 €	2,92 €	1	12
NFA1\2X25	1/2"x25	4,19 €	4,65 €	1	12
NFA3\4X20	3/4"x20	3,95 €	4,38 €	1	12
NFA3\4X25	3/4"x25	4,00 €	4,44 €	1	12
NFA11\4X40	11/4"x40	19,98 €	22,18 €	1	12
NFA11\2X50	11/2"x50	22,42 €	24,88 €	1	12
NFA2X63	2"x63	36,07 €	40,03 €	1	12



Manicotto Polipropilene Ff D. 32

Codice	Riferimenti	Listino A	Listino B	Off.	Box
MA20	20x20	0,33 €	0,37 €	1	12
MA25	25x25	0,50 €	0,55 €	1	12
MA32	32x32	0,73 €	0,81 €	1	12
MA40	40x40	1,80 €	2,00 €	1	12
MA50	50x50	2,58 €	2,87 €	1	12
MA63	63x63	5,82 €	6,46 €	1	12
MA75	75X75	10,54 €	11,69 €	1	12



Gomito Ff Polipropilene Da 32

Codice	Riferimenti	Listino A	Listino B	Off.	Box
GA20	20x20	0,44 €	0,49 €	1	12
GA25	25x25	0,58 €	0,64 €	1	12
GA32	32x32	0,88 €	0,97 €	1	12
GA40	40x40	2,10 €	2,33 €	1	12
GA50	50x50	4,00 €	4,44 €	1	12
GA63	63x63	8,98 €	9,97 €	1	12
GA75	75X75	14,48 €	16,07 €	1	12



Tee Polipropilene Da 32

Codice	Riferimenti	Listino A	Listino B	Off.	Box
TA20	20x20x20	0,50 €	0,55 €	1	12
TA25	25x25x25	0,58 €	0,64 €	1	12
TA32	32x32x32	0,96 €	1,06 €	1	12
TA40	40x40x40	2,24 €	2,49 €	1	12
TA50	50x50x50	4,78 €	5,30 €	1	12
TA63	63x63x63	9,79 €	10,87 €	1	12
TA75	75X75x75	22,92 €	25,44 €	1	12



Curva Aperta Polipropilene D.32

Codice	Riferimenti	Listino A	Listino B	Off.	Box
CAA20	20x20	0,55 €	0,61 €	1	12
CAA25	25x25	0,79 €	0,88 €	1	12
CAA32	32x32	1,25 €	1,38 €	1	12
CAA40	40x40	2,05 €	2,27 €	1	12
CAA50	50x50	4,63 €	5,14 €	1	12
CAA63	63x63	7,70 €	8,55 €	1	12
CAA75	75X75	9,82 €	10,90 €	1	12



Riduzion Polipropilene 25X20 M /F

Codice	Riferimenti	Listino A	Listino B	Off.	Box
RA25X20	20x25	0,47 €	0,52 €	1	12
RA32X20	20x32	0,58 €	0,65 €	1	12
RA32X25	25x32	0,68 €	0,76 €	1	12
RA40X32	32x40	1,56 €	1,73 €	1	12
RA50X32	32x50	2,44 €	2,70 €	1	12
RA50X40	40x50	2,44 €	2,71 €	1	12
RA63X50	50x63	4,58 €	5,08 €	1	12
RA75X63	63x75	4,55 €	5,05 €	1	12



Sorpasso Sald. Polipropilene 20

Codice	Riferimenti	Listino A	Listino B	Off.	Box
SSA20	20x20	2,07 €	2,29 €	1	12
SSA25	25x25	2,63 €	2,92 €	1	12



Gomit Flang. Polipropilene 1/2"X20

Codice	Riferimenti	Listino A	Listino B	Off.	Box
GFLA1/2X20	1/2"x20	2,92 €	3,25 €	1	12



Rubinetto A Sfera Con Maniglia Dn 25

Codice	Riferimenti	Listino A	Listino B	Off.	Box
RIA20	D.. 20x20	31,19 €	34,62 €	1	12
RIA25	D.. 25x25	32,17 €	35,70 €	1	12



Rubinetto D'Arresto A Vitone Con Cappuccio D. 25

Codice	Riferimenti	Listino A	Listino B	Off.	Box
RCA20	D.. 20x20	14,37 €	15,95 €	1	12
RCA25	D.. 25x25	16,62 €	18,45 €	1	12



Rubinetto D'Arresto A Vitone Con Maniglia D 25

Codice	Riferimenti	Listino A	Listino B	Off.	Box
RIAP20	D.. 20x20	21,02 €	23,33 €	1	12
RIAP25	D.. 25x25	24,29 €	26,96 €	1	12



Rubinetto D'Arresto A Spera Con Cappuccio D. 25

Codice	Riferimenti	Listino A	Listino B	Off.	Box
RICA20	D.. 20x20	25,83 €	28,67 €	1	12
RICA25	D.. 25x25	27,78 €	30,84 €	1	12



Gomito Giallo Da 1/2" Ff



Codice	Riferimenti	Listino A	Listino B	Off.	Box
GG1/2	1/2" FF	2,89 €	3,21 €	1	12
GG3/4	3/4" FF	3,67 €	4,07 €	1	12
GG1	1" FF	5,66 €	6,28 €	1	12
GG11/4	1"1/4 FF	7,45 €	8,27 €	1	12



Gomito Giallo Da 1/2" Mf



Codice	Riferimenti	Listino A	Listino B	Off.	Box
GG1/2MF	1/2" MF	2,58 €	2,86 €	1	12
GG3/4MF	3/4" MF	3,39 €	3,76 €	1	12
GG1MF	1" MF	6,39 €	7,10 €	1	12
GG11/4MF	1"1/4 MF	8,58 €	9,53 €	1	12



Raccordo Tre Vie Gialla D. 1/2"



Codice	Riferimenti	Listino A	Listino B	Off.	Box
TG1/2	1/2" FFF	2,84 €	3,15 €	1	12
TG3/4	3/4" FFF	4,46 €	4,95 €	1	12
TG1	1" FFF	7,58 €	8,42 €	1	12
TG11/4	1"1/4 FFF	9,24 €	10,25 €	1	12



Manicotto Giallo 1/2"

Codice	Riferimenti	Listino A	Listino B	Off.	Box
MG1/2	1/2" FF	1,50 €	1,67 €	1	12
MG3/4	3/4" FF	2,30 €	2,55 €	1	12
MG1	1" FF	3,83 €	4,26 €	1	12
MG11/4	1"1/4 FF	4,68 €	5,20 €	1	12



Niples Gialla Da 1/4

Codice	Riferimenti	Listino A	Listino B	Off.	Box
NG1/4	1/4" MM	0,50 €	0,56 €	1	12
NG3/8	3/8" MM	0,78 €	0,86 €	1	12
NG1/2	1/2" MM	1,10 €	1,22 €	1	12
NG3/4	3/4" MM	1,86 €	2,07 €	1	12
NG1	1" MM	2,83 €	3,14 €	1	12
NG11/4	1"1/4 MM	4,40 €	4,89 €	1	12



Niples Rid.Ott. Giallo 1/2"X1/4

Codice	Riferimenti	Listino A	Listino B	Off.	Box
NRG1/2X1/4	1/2"X 1/4"	0,69 €	0,77 €	1	12
NRG1/2x3/8	1/2"X 3/8"	1,39 €	1,55 €	1	12
NRG3/4X1/2	3/4"X 1/2"	1,55 €	1,72 €	1	12
NRG1X1/2	1" X 1/2"	2,02 €	2,24 €	1	12
NRG1X3/4	1" X 3/4"	2,53 €	2,81 €	1	12
NRG11/4X3/4	1"1/4 X 3/4"	3,82 €	4,24 €	1	12



Tappo Giallo Maschio D. 1/4

Codice	Riferimenti	Listino A	Listino B	Off.	Box
TGM1/4	1/4" M	0,57 €	10	€ 0,50	235
TGM3/8	3/8" M	0,62 €	10	€ 0,55	582
TGM1/2	1/2" M	0,92 €	10	€ 0,81	2261
TGM3/4	3/4" M	1,44 €	10	€ 1,26	767
TGM1	1" M	1,48 €	10	€ 1,30	1859
TGM11/4	1"1/4 M	3,21 €	10	€ 2,81	249



Tappo Giallo Femmina D. 1/4"

Codice	Riferimenti	Listino A	Listino B	Off.	Box
TGF1/4	1/4" F	0,28 €	10	€ 0,25	156
TGF3/8	3/8" F	0,60 €	10	€ 0,52	626
TGF1/2	1/2" F	0,62 €	10	€ 0,54	403
TGF3/4	3/4" F	1,54 €	10	€ 1,34	2912
TGF1	1" F	1,48 €	10	€ 1,30	423
TGF11/4	1"1/4 F	2,69 €	10	€ 2,35	405



Gomito Giallo 3 Pz Mf Da 1/2"

Codice	Riferimenti	Listino A	Listino B	Off.	Box
G3G1/2MF	1/2" MF	2,63 €	2,92 €	1	12
G3G3/4MF	3/4" MF	12,13 €	13,47 €	1	12
G3G1MF	1" MF	18,48 €	20,51 €	1	12



Raccordo 3 Pz. Giallo 1/2" Mf

Codice	Riferimenti	Listino A	Listino B	Off.	Box
R3G1/2MF	1/2" MF	2,53 €	2,81 €	1	12
R3G3/4MF	3/4" MF	3,92 €	4,35 €	1	12
R3G1MF	1" MF	10,84 €	12,03 €	1	12
R3G11/4MF	11/4" MF	11,80 €	13,10 €	1	12



Manicotto Rid. G. Ff 1/2"X3/8"

Codice	Riferimenti	Listino A	Listino B	Off.	Box
MRG1\2X3\8	1/2X3/8 FF	0,92 €	1,02 €	1	12
MRG3\4X1\2	3/4X1/2 FF	1,72 €	1,91 €	1	12
MRG1X1\2	1"X1/2 FF	2,20 €	2,44 €	1	12
MRG1X3\4	1"X3/4 FF	2,74 €	3,04 €	1	12



Prolunga Rid. Ott.G. 1/2"X3/8"

Codice	Riferimenti	Listino A	Listino B	Off.	Box
PRG1\2X3\8	1/2X3/8 FM	1,20 €	1,34 €	1	12
PRG3\4X1\2	3/4X1/2 FM	2,26 €	2,50 €	1	12
PRG1X1\2	1"X1/2 FM	2,91 €	3,23 €	1	12
PRG1X3\4	1"X3/4 FM	3,32 €	3,69 €	1	12
PRG11\4X1	11/4X1 FM	5,10 €	5,66 €	1	12



Gomito Giallo Ridotto 3/4"X1/2"

Codice	Riferimenti	Listino A	Listino B	Off.	Box
GGRGD	1/2X3/8	Arrivo	Arrivo	1	12
GGRHD	3/4x1/2"	2,05 €	2,28 €	1	12
GGRHG	1"x1/2"	7,31 €	8,12 €	1	12
GGRHG	1"x3/4"	4,36 €	4,84 €	1	12



Raccordo Tre Vie Gialla D. 1" Maschio

Codice	Riferimenti	Listino A	Listino B	Off.	Box
TG1M	1"	8,68 €	9,64 €	1	12



Rid. Ott.G. 1/2"X3/8 Prolungata

Codice	Riferimenti	Listino A	Listino B	Off.	Box
RG1\2X3\8P	1/2"x3/8"	0,98 €	1,09 €	1	12
RG3\4X1\2P	3/4x1/2"	1,52 €	1,68 €	1	12



Controdado Flangia Giallo 1/2"

Codice	Riferimenti	Listino A	Listino B	Off.	Box
CF1\2	1/2"	0,79 €	0,87 €	1	12
CF3\4	3/4"	1,04 €	1,16 €	1	12
CF1	1"	1,25 €	1,39 €	1	12
CF11\4	1" 1\4	1,46 €	1,62 €	1	12



Gomito Ottone Giallo 1/2" Flangiato

Codice	Riferimenti	Listino A	Listino B	Off.	Box
GGF1\2	1/2"	1,78 €	1,98 €	1	12



Prolunga Ott. G. 1/2"X10 P.

Codice	Riferimenti	Listino A	Listino B	Off.	Box
PG1\2X10P	1\2"X10 mm	1,29 €	1,43 €	1	12
PG1\2X15P	1\2"X15 mm	1,44 €	1,60 €	1	12
PG1\2X20P	1\2"X20 mm	1,76 €	1,95 €	1	12
PG1\2X25P	1\2"X25 mm	1,49 €	1,65 €	1	12

Prolunga Gialla 3/4"X10 Pes.

Codice	Riferimenti	Listino A	Listino B	Off.	Box
PG3\4X10P	3\4"X10 mm	2,44 €	2,71 €	1	12
PG3\4X15P	3\4"X15 mm	2,11 €	2,34 €	1	12
PG3\4X20P	3\4"X20 mm	2,63 €	2,92 €	1	12
PG3\4X25P	3\4"X25 mm	1,76 €	1,95 €	1	12

Prolunga Gialla Pes. 1"X10

Codice	Riferimenti	Listino A	Listino B	Off.	Box
PG1X10P	1"X10 mm	3,74 €	4,15 €	1	12
PG1X15P	1"X15 mm	3,22 €	3,57 €	1	12
PG1X20P	1"X20 mm	3,65 €	4,06 €	1	12
PG1X25P	1"X25 mm	5,25 €	5,82 €	1	12



Raccordo 3 Pz Ott. Giallo 1/2"

Codice	Riferimenti	Listino A	Listino B	Off.	Box
BG1\2	1/2"	6,67 €	7,40 €	1	12
BG3\4	3/4"	8,48 €	9,41 €	1	12
BG1	1"	10,81 €	12,00 €	1	12
BG11\4	1" 1\4	18,96 €	21,05 €	1	12
BG11\2	1" 1\2	26,50 €	29,41 €	1	12
BG2	2"	40,28 €	44,71 €	1	12



Raccordo 3 Pz Ott. Giallo 1/2" MF

Codice	Riferimenti	Listino A	Listino B	Off.	Box
BG1\2MF	1/2"	4,91 €	5,45 €	1	12
BG3\4MF	3/4"	7,23 €	8,02 €	1	12
BG1MF	1"	10,84 €	12,03 €	1	12
BG11\4MF	1" 1\4	15,70 €	17,43 €	1	12
BG11\2MF	1" 1\2	21,24 €	23,57 €	1	12
BG2MF	2"	31,45 €	34,91 €	1	12



Riduzione Gialla 1/2"X3/8"

Codice	Riferimenti	Listino A	Listino B	Off.	Box
RG1\2X3\8	1/2"x3/8"	0,63 €	0,70 €	1	12
RG3\4X1\2	3/4x1/2"	1,29 €	1,43 €	1	12
RG1X1\2	1"x1/2"	2,05 €	2,28 €	1	12
RG1X3\4	1"x3/4"	1,74 €	1,93 €	1	12
RG11\4X1	1"1\4X1"	3,02 €	3,36 €	1	12



Kronos Femm. Riparatubi 3/8"

Codice	Riferimenti	Listino A	Off.	Listino B	Box
KF3/8	D.. 3/8"	6,93 €	10	€ 6,07	13
KF1/2	D.. 1/2"	8,17 €	10	€ 7,15	28
KF3/4	D.. 3/4"	11,28 €	10	€ 9,87	147
KF1	D.. 1"	13,71 €	10	€ 11,99	74



Kronos Maschio Riparatubi 3/8"

Codice	Riferimenti	Listino A	Listino B	Off.	Box
KM3/8	D.. 3/8"	6,93 €	7,70 €	1	12
KM1/2	D.. 1/2"	8,03 €	8,91 €	1	12
KM3/4	D.. 3/4"	11,28 €	12,52 €	1	12
KM1	D.. 1"	12,59 €	13,97 €	1	12



Tee Cromata Da 3/8"

Codice	Riferimenti	Listino A	Listino B	Off.	Box
TC3/8	D.. 3/8"	1,92 €	2,13 €	1	12
TC1/2	D.. 1/2"	3,27 €	3,63 €	1	12
TC3/4	D.. 3/4"	4,95 €	5,49 €	1	12
TC1	D.. 1"	7,27 €	8,07 €	1	12



Manicotto Cromo Da 3/8"

Codice	Riferimenti	Listino A	Listino B	Off.	Box
MC3/8	D.. 3/8"	1,29 €	1,44 €	1	12
MC1/2	D.. 1/2"	1,38 €	1,53 €	1	12
MC3/4	D.. 3/4"	2,28 €	2,53 €	1	12
MC1	D.. 1"	3,70 €	4,11 €	1	12



Tappo Maschio Cromo 3/8"

Codice	Riferimenti	Listino A	Listino B	Off.	Box
TCM3/8	D.. 3/8"	0,72 €	0,80 €	1	12
TCM1/2	D.. 1/2"	0,91 €	1,01 €	1	12
TCM3/4	D.. 3/4"	1,29 €	1,44 €	1	12
TCM1	D.. 1"	2,05 €	2,28 €	1	12



Gomito Cromato Ff 3/8"

Codice	Riferimenti	Listino A	Off.	Listino B	Box
GC3/8	D.. 3/8"	1,74 €	10	€ 1,52	218
GC1/2	D.. 1/2"	2,15 €	10	€ 1,88	175
GC3/4	D.. 3/4"	2,53 €	10	€ 2,21	110
GC1	D.. 1"	4,14 €	10	€ 3,62	50



Gomito Cromo 3/8" Mf Zx

Codice	Riferimenti	Listino A	Listino B	Off.	Box
GC3/8MF	D.. 3/8"	1,74 €	1,93 €	1	12
GC1/2MF	D.. 1/2"	2,11 €	2,34 €	1	12
GC3/4MF	D.. 3/4"	2,95 €	3,27 €	1	12
GC1MF	D.. 1"	6,76 €	7,50 €	1	12



Niplo Cromato Da 3/8"

Codice	Riferimenti	Listino A	Listino B	Off.	Box
NC3/8	D.. 3/8"	0,94 €	1,04 €	1	12
NC1/2	D.. 1/2"	1,16 €	1,29 €	1	12
NC3/4	D.. 3/4"	1,66 €	1,84 €	1	12
NC1	D.. 1"	2,72 €	3,02 €	1	12



Nipples Cromo Mm 1/2"X3/8"

Codice	Riferimenti	Listino A	Listino B	Off.	Box
NCR1\2X3\8	1/2M X3/8M	1,51 €	1,68 €	1	12
NCR3\4X1\2	3/4 M X1/2M	2,55 €	2,83 €	1	12



Tappo Femmina Cromo Da 3/8"

Codice	Riferimenti	Listino A	Listino B	Off.	Box
TCF3/8	D.. 3/8"	0,83 €	0,92 €	1	12
TCF1/2	D.. 1/2"	0,88 €	0,98 €	1	12
TCF3/4	D.. 3/4"	1,38 €	1,54 €	1	12
TCF1	D.. 1"	1,96 €	2,18 €	1	12



Riduzione Cromo 1/2"X3/8"

Codice	Riferimenti	Listino A	Listino B	Off.	Box
RC1\2X3\8	1/2M X3/8F	1,17 €	1,30 €	1	12
RC3\4X1\2	3/4M X1/2F	1,12 €	1,24 €	1	12



Nipples Cromo F. 1/2"X10

Codice	Riferimenti	Listino A	Listino B	Off.	Box
NFC1\2X10	10 x 1/2	1,64 €	1,83 €	1	12



Prolunga Rid. Cr. F/M 3/4"X1/2"

Codice	Riferimenti	Listino A	Listino B	Off.	Box
PRC1\2X3\8	1/2F X3/8M	1,44 €	1,59 €	1	12
PRC3\4X1\2	3/4F X1/2M	2,04 €	2,26 €	1	12
PRC1X3\4	1F X3/4M	3,67 €	4,07 €	1	12
PRC1X1\2	1F X1/2M	4,55 €	5,05 €	1	12



Niplo Cromo Mon.1/2"X
3/8"X10

Codice	Riferimenti	Listino A	Listino B	Off.	Box
NM3\8X10	10 x 3/8	0,89 €	0,98 €	1	12
NMC1\2X10	10 x 1/2	1,64 €	1,83 €	1	12



Prolunga Ott. Cromato 3/8"X15

Codice	Riferimenti	Listino A	Listino B	Off.	Box
PC3\8X10	3/8X10 mm	0,99 €	1,10 €	1	12
PC3\8X15	3/8X15 mm	1,17 €	1,30 €	1	12
PC3\8X20	3/8X20 mm	1,53 €	1,70 €	1	12
PC3\8X25	3/8X25 mm	1,74 €	1,93 €	1	12
PC3\8X30	3/8X30 mm	2,12 €	2,35 €	1	12
PC3\8X40	3/8X40 mm	2,14 €	2,38 €	1	12
PC3\8X50	3/8X50 mm	2,80 €	3,11 €	1	12



Nipples Esag.1/2"X3/8"X10 C/Ro

Codice	Riferimenti	Listino A	Listino B	Off.	Box
NMCPD10	1/2"X(3/8"X10)	2,35 €	2,61 €	1	12



Nipples Ridotta Prolungata
Cromata 1/2"X3/8

Codice	Riferimenti	Listino A	Listino B	Off.	Box
NCPRDC	1/2"X3/8"	2,16 €	2,40 €	1	12
NCPRDD	1/2"X1/2"	1,85 €	2,05 €	1	12



Prolunga Ott. Cromato 1/2"X15

Codice	Riferimenti	Listino A	Listino B	Off.	Box
PC1\2X10	1/2X10 mm	1,14 €	1,27 €	1	12
PC1\2X15	1/2X15 mm	1,74 €	1,93 €	1	12
PC1\2X20	1/2X20 mm	1,59 €	1,76 €	1	12
PC1\2X25	1/2X25 mm	2,56 €	2,84 €	1	12
PC1\2X30	1/2X30 mm	2,92 €	3,25 €	1	12



Rame Cotto Cromato Da 10 Mm

Codice	Riferimenti	Listino A	Listino B	Off.	Box
RC10	Mt. 5	5,13 €	5,69 €	1	5



Prolunga Ott. Cromato 3/4"X10

Codice	Riferimenti	Listino A	Listino B	Off.	Box
PC3\4X10	3/4X10 mm	2,20 €	2,44 €	1	12
PC3\4X15	3/4X15 mm	2,94 €	3,27 €	1	12
PC3\4X20	3/4X20 mm	2,43 €	2,69 €	1	12
PC3\4X25	3/4X25 mm	2,89 €	3,21 €	1	12



Rubinetto A "T" X Lav.1/2"X3/4"

Codice	Riferimenti	Listino A	Listino B	Off.	Box
RTL	Cromo	7,00 €	7,77 €	1	12
RTLx5	Off.x5	6,53 €	7,25 €	5	12



Raccordo Cromo 1/2"M "Y"Usc.
F.

Codice	Riferimenti	Listino A	Listino B	Off.	Box
RCY1\2		5,75 €	6,38 €	1	12



Raccordo Cassone A Piletta

Codice	Riferimenti	Listino A	Listino B	Pz	Box
RCP1\2	1/2"	4,01 €	4,45 €	1	10
RCP3\4	3/4"	5,71 €	6,34 €	1	10
RCP1	1"	7,11 €	7,89 €	1	5
RCP11\4	1" 1\4	9,91 €	11,00 €	1	5



Raccordo Cassone con raccordo smontabile

Codice	Riferimenti	Listino A	Listino B	Pz	Box
R3C1\2	1/2"	4,96 €	5,50 €	1	10
R3C3\4	3/4"	7,86 €	8,72 €	1	10
R3C1	1"	10,83 €	12,02 €	1	5
R3C11\4	1" 1\4	14,92 €	16,56 €	1	5



Portagomma In Ottone Maschio

Codice	Riferimenti	Listino A	Listino B	Off.	Box
PGM1\2X13	1/2X13	1,12 €	1,24 €	1	10
PGM3\4X20	3/4X20	1,90 €	2,11 €	1	10
PGM1X25	1"X25	2,97 €	3,30 €	1	5
PGM11\4X30	1"1/4X30	3,17 €	3,52 €	1	5
PGM11\4X40	1"1/4X40	4,39 €	4,87 €	1	5
PGM11\2X40	1"1/2X40	4,98 €	5,53 €	1	5
PGM2X50	2"X50	6,99 €	7,76 €	1	3



Portagomma In Ottone Maschio con bocchettone "Excelsior"

Codice	Riferimenti	Listino A	Listino B	Off.	Box
RE1\2	1/2X15	3,00 €	3,33 €	1	10
RE3\4	3/4X20	5,35 €	5,94 €	1	10
RE1	1"X25	8,97 €	9,96 €	1	5
RE11\4	1"1/4X30	11,92 €	13,23 €	1	5
RE11\2	1"1/2X40	13,26 €	14,72 €	1	5
RE2	2"X50	19,80 €	21,98 €	1	5



Barilotto in Ottone Giallo

Codice	Riferimenti	Listino A	Listino B	Off.	Box
BG1\2X40	1/2"X40	2,23 €	2,48 €	1	10
BG1\2X50	1/2"X50	1,84 €	2,05 €	1	10
BG1\2X60	1/2"X60	2,23 €	2,48 €	1	10
BG1\2X70	1/2"X70	2,55 €	2,83 €	1	10
BG1\2X80	1/2"X80	3,50 €	3,88 €	1	10
BG1\2X100	1/2"X100	4,90 €	5,44 €	1	10
BG1\2X150	1/2"X150	6,65 €	7,38 €	1	10
BG1\2X200	1/2"X200	9,53 €	10,58 €	1	10
BG3\4X50	3/4"X50	2,97 €	3,30 €	1	10
BG3\4X60	3/4"X60	2,97 €	3,30 €	1	10
BG3\4X70	3/4"X70	3,30 €	3,66 €	1	10
BG3\4X80	3/4"X80	3,85 €	4,27 €	1	10
BG3\4X100	3/4"X100	5,43 €	6,03 €	1	10
BG3\4X150	3/4"X150	9,28 €	10,30 €	1	10
BG3\4X200	3/4"X200	11,13 €	12,35 €	1	10
BG1X50	1"X50	3,89 €	4,32 €	1	10
BG1X60	1"X60	3,98 €	4,42 €	1	10
BG1X70	1"X70	4,57 €	5,08 €	1	10
BG1X80	1"X80	5,23 €	5,80 €	1	10
BG1X100	1"X100	9,04 €	10,03 €	1	10
BG1X150	1"X150	12,87 €	14,28 €	1	10
BG1X200	1"X200	15,66 €	17,38 €	1	10



Tappo Maschio Con Rosetta 1/2"

Codice	Riferimenti	Listino A	Listino B	Off.	Box
TMCR		1,83 €	2,03 €	1	20
TMCRx5	Offertax5	1,73 €	1,92 €	5	20
TMCRx10	Offertax10	1,64 €	1,82 €	10	20
TMCRx20	Offertax20	1,56 €	1,73 €	20	20



Prolunga Ridotta Cromata 1 1/4" F X1" M Zz Ex Prc11/4X1

Codice	Riferimenti	Listino A	Listino B	Off.	Box
PROCHBH	1" 1/4 x 1"	5,14 €	5,70 €	1	10
PROCHDHB	1" 1/2 x 1" 1/4	5,14 €	5,70 €	1	10



Riduzione Cromata D. 1 1/2" M x 1 1/4" F

Codice	Riferimenti	Listino A	Listino B	Off.	Box
RM114100	1" 1/4 x 1"	5,14 €	5,70 €	1	10
RM1121140	1" 1/2 x 1" 1/4	6,33 €	7,02 €	1	10



Collare Riparazione 1 Tirante

Codice	Riferimenti	Listino A	Listino B	Off.	Box
030200	21/25	9,11 €	10,11 €	1	10
030201	26/30	9,11 €	10,11 €	1	10
030202	33/37	9,56 €	10,62 €	1	10
030203	42/45	10,48 €	11,63 €	1	10
030204	48/51	10,48 €	11,63 €	1	10
030205	60/64	14,35 €	15,92 €	1	10



Collare Di Presa In A 4 Bullone 50 3/4"-1"

Codice	Riferimenti	Listino A	Listino B	Off.	Box
072030	50 3/4"-1"	37,98 €	42,16 €	1	10
072031	63 3/4"-11/4"	40,31 €	44,74 €	1	10
072032	75 3/4"-1"1/4"	63,31 €	70,27 €	1	10
072033	90 1"-2"	70,59 €	78,36 €	1	10
072034	110 1"1/4-2"	84,26 €	93,52 €	1	10
072035	125 1"1/4-2"	97,92 €	108,69 €	1	10



Collare Riparazione Permanente 48/56

Codice	Riferimenti	Listino A	Listino B	Off.	Box
030220	48/56	107,03 €	118,80 €	1	1
030221	56/64	107,03 €	118,80 €	1	1
030222	60/68	109,30 €	121,33 €	1	1



Giunto Diel. Gas Pn10 1/2" Mf

Codice	Riferimenti	Listino A	Listino B	Off.	Box
GDG11/2MF	D. 1/2"	13,03 €	14,46 €	1	10
GDG3/4MF	D. 3/4"	29,17 €	32,38 €	1	10
GDG1MF	D. 1"	35,76 €	39,69 €	1	10
GDG11/4MF	D. 1 1/4"	47,82 €	53,08 €	1	10
GDG11/2MF	D. 1 1/2"	57,38 €	63,70 €	1	10
GDG2MF	D. 2"	70,67 €	78,44 €	1	10



Presse a staffa

Art. 610

REFERENZE - MISURA
 C=3/8" H =1" OL =
 2" D= 1/2" HB= 11/4"
 OLD=21/2"
 G= 3/4" HD=11/2" Y=3"
 Z=4"

Codice	Riferimenti	Listino A	Listino B	Off.	Box
610-D20	1/2"x20	1,07 €	1,19 €	1	10
610-D25	1/2"x25	1,04 €	1,15 €	1	10
610-G25	3/4"x25	1,07 €	1,19 €	1	10
610-D32	1/2"x32	1,20 €	1,33 €	1	10
610-G32	3/4"x32	1,20 €	1,33 €	1	10
610-D40	1/2"x40	1,42 €	1,57 €	1	10
610-G40	3/4"x40	1,42 €	1,57 €	1	10
610-H40	1"x40	1,39 €	1,54 €	1	10
610-D50	1/2"x50	1,92 €	2,13 €	1	10
610-G50	3/4"x50	1,70 €	1,89 €	1	10
610-H50	1"x50	1,92 €	2,13 €	1	10
610-HB50	1 1/4"x50	2,05 €	2,27 €	1	10
610-D63	1/2"x63	2,05 €	2,27 €	1	10
610-G63	3/4"x63	2,90 €	3,22 €	1	10
610-H63	1"x63	2,90 €	3,22 €	1	10
610-HB63	1 1/4"x63	2,27 €	2,52 €	1	10
610-D75	1/2"x75	2,33 €	2,59 €	1	10
610-G75	3/4"x75	2,33 €	2,59 €	1	10
610-H75	1"x75	2,33 €	2,59 €	1	10
610-HB75	1 1/4"x75	2,46 €	2,73 €	1	10
610-HD75	1 1/2"x75	2,46 €	2,73 €	1	10
610-OL75	2"x75	2,46 €	2,73 €	1	10
610-D90	1/2"x90	2,93 €	3,25 €	1	10
610-G90	3/4"x90	2,93 €	3,25 €	1	10
610-H90	1"x90	2,93 €	3,25 €	1	10
610-HB90	1 1/4"x90	3,18 €	3,53 €	1	10
610-HD90	1 1/2"x90	2,93 €	3,25 €	1	10
610-OL90	2"x90	2,93 €	3,25 €	1	10
610-D110	1/2"x110	3,62 €	4,02 €	1	10
610-G110	3/4"x110	3,62 €	4,02 €	1	10



Filtro Gas Da 1 1/2" Zx

Codice	Riferimenti	Listino A	Listino B	Off.	Box
FG11/2E	1/2"	12,65 €	14,04 €	1	10
FG3/4E	3/4"	12,65 €	14,04 €	1	10
FG1E	1"	22,32 €	24,77 €	1	10



Gomito Zincato Mf
Fig.92



Visualizza la gamma completa

Codice	Riferimenti	Listino A	Listino B	Off.	Box
GZ1\2MF	D. 1/2"	0,68 €	0,76 €	1	10
GZ3\4MF	D. 3/4"	1,38 €	1,53 €	1	10
GZ1MF	D. 1"	1,94 €	2,15 €	1	10
GZ11\4MF	D. 1 1/4"	3,33 €	3,70 €	1	10



Gomito Zincato
Fig. 90



Visualizza la gamma completa

Codice	Riferimenti	Listino A	Listino B	Off.	Box
GZ1\2	D. 1/2"	0,76 €	0,84 €	1	10
GZ3\4	D. 3/4"	1,38 €	1,53 €	1	10
GZ1	D. 1"	2,09 €	2,32 €	1	10
GZ11\4	D. 1 1/4"	3,63 €	4,03 €	1	10



Tee Zincato Fig.
130



Visualizza la gamma completa

Codice	Riferimenti	Listino A	Listino B	Off.	Box
TZ1\2	D. 1/2"	1,02 €	1,13 €	1	10
TZ3\4	D. 3/4"	1,76 €	1,96 €	1	10
TZ1	D. 1"	2,00 €	2,22 €	1	10
TZ11\4	D. 1 1/4"	3,86 €	4,29 €	1	10



Manicotto Zincato
F.270



Visualizza la gamma completa

Codice	Riferimenti	Listino A	Listino B	Off.	Box
MZ1\2	D. 1/2"	0,87 €	0,97 €	1	10
MZ3\4	D. 3/4"	1,18 €	1,31 €	1	10
MZ1	D. 1"	1,57 €	1,74 €	1	10
MZ11\4	D. 1 1/4"	2,46 €	2,73 €	1	10



Niples Zincato Fig.280



Visualizza la gamma completa

Codice	Riferimenti	Listino A	Listino B	Off.	Box
NZ1\2	D. 1/2"	0,58 €	0,64 €	1	10
NZ3\4	D. 3/4"	1,00 €	1,11 €	1	10
NZ1	D. 1"	1,46 €	1,62 €	1	10
NZ11\4	D. 1 1/4"	2,63 €	2,92 €	1	10



Tappo Maschio Zincato



Visualizza la gamma completa

Codice	Riferimenti	Listino A	Listino B	Off.	Box
TZM1\2	D. 1/2"	0,89 €	0,98 €	1	10
TZM3\4	D. 3/4"	0,61 €	0,68 €	1	10
TZM1	D. 1"	0,67 €	0,75 €	1	10
TZM11\4	D. 1 1/4"	1,24 €	1,38 €	1	10



Raccordo Bocchettone
FF 3 Pz Conico Zincato



Visualizza la gamma completa

Codice	Riferimenti	Listino A	Listino B	Off.	Box
BZ1\2	D. 1/2"	2,91 €	3,23 €	1	10
BZ3\4	D. 3/4"	3,29 €	3,65 €	1	10
BZ1	D. 1"	4,30 €	4,77 €	1	10
BZ11\4	D. 1 1/4"	6,53 €	7,25 €	1	10



Riduzione Zincata Mf



Visualizza la gamma completa

Codice	Riferimenti	Listino A	Listino B	Off.	Box
RZ3\4X1\2	3/4"x1/2"	0,82 €	0,91 €	1	10
RZ1X1\2	1"x1/2"	1,15 €	1,28 €	1	10
RZ1X3\4	1"x3/4"	0,84 €	0,93 €	1	10
RZ11\4X1\2	1 1/4"x1/2"	1,99 €	2,21 €	1	10



Collare Pesante
Completo

Codice	Riferimenti	Listino A	Listino B	Off.	Box
CPT1\2	D.1/2"	0,58 €	0,64 €	1	10
CPT3\4	D.3/4"	0,62 €	0,69 €	1	10
CPT1	D.1"	0,64 €	0,71 €	1	10
CPT11\4	D.1"1/4	0,68 €	0,75 €	1	10
CPT11\2	D.1"1/2	0,72 €	0,79 €	1	10
CPT2	D.2"	0,82 €	0,91 €	1	10



Tubi Zincati Saldati
Norme Uni

Codice	Riferimenti	Listino A	Listino B	Off.	Box
TZ1\2E	D. 1/2"	34,73 €	38,56 €	1	20
TZ3\4E	D. 3/4"	42,63 €	47,32 €	1	10
TZ1E	D. 1"	61,45 €	68,21 €	1	10
TZ11\4E	D. 1 1/4"	78,82 €	87,49 €	1	5
TZ11\2E	D.1"1/2	83,47 €	92,65 €	1	5
TZ2E	D.2"	113,82 €	126,34 €	1	5



Gomito Zinc. 3 V. 1/2"

F.
221

[Visualizza la gamma completa](#)

Codice	Riferimenti	Listino A	Listino B	Off.	Box
GZ3V1/2	D. 1/2"	2,47 €	2,74 €	1	5
GZ3V3/4	D. 3/4"	3,95 €	4,38 €	1	5
GZ3V1	D. 1"	5,22 €	5,79 €	1	5
GZ3V11/4	D. 1 1/4"	9,25 €	10,27 €	1	5



Tappo Femmina

Zincato
F. 300

[Visualizza la gamma completa](#)

Codice	Riferimenti	Listino A	Listino B	Off.	Box
TZF1/2	D. 1/2"	0,98 €	1,09 €	1	10
TZF3/4	D. 3/4"	0,88 €	0,98 €	1	10
TZF1	D. 1"	1,04 €	1,15 €	1	10
TZF11/4	D. 1 1/4"	1,56 €	1,73 €	1	10



Barilotto Zincato
1/2"X10 Cm

[Visualizza la gamma completa](#)

Codice	Riferimenti	Listino A	Listino B	Off.	Box
BZ1\2X100	1/2"X100mm	1,41 €	1,56 €	1	10
BZ1\2X150	1/2"X150mm	1,88 €	2,09 €	1	10
BZ1\2X200	1/2"X200mm	1,29 €	1,43 €	1	10
BZ1\2X250	1/2"X250mm	1,63 €	1,81 €	1	10
BZ1\2X300	1/2"X300mm	1,77 €	1,97 €	1	10
BZ1\2X400	1/2"X400mm	4,83 €	5,36 €	1	10
BZ1\2X500	1/2"X500mm	5,77 €	6,40 €	1	10
BZ1\2X1000	1/2"X1000mm	11,13 €	12,36 €	1	10

Barilotto Zincato 3/4"X10 Cm

Codice	Riferimenti	Listino A	Listino B	Off.	Box
BZ3\4X100	3/4"X100mm	0,94 €	1,05 €	1	10
BZ3\4X150	3/4"X150mm	1,23 €	1,37 €	1	10
BZ3\4X200	3/4"X200mm	1,47 €	1,63 €	1	10
BZ3\4X250	3/4"X250mm	1,82 €	2,02 €	1	10
BZ3\4X300	3/4"X300mm	2,15 €	2,39 €	1	10
BZ3\4X400	3/4"X400mm	6,04 €	6,71 €	1	10
BZ3\4X500	3/4"X500mm	7,18 €	7,96 €	1	10
BZ3\4X1000	3/4"X1000mm	6,88 €	7,64 €	1	10

Barilotto Zincato 1"X10 Cm.

Codice	Riferimenti	Listino A	Listino B	Off.	Box
BZ1X100	1"X100mm	1,16 €	1,29 €	1	5
BZ1X150	1"X150mm	1,64 €	1,83 €	1	5
BZ1X200	1"X200mm	2,93 €	3,26 €	1	5
BZ1X250	1"X250mm	2,73 €	3,03 €	1	5
BZ1X300	1"X300mm	3,26 €	3,62 €	1	5
BZ1X400	1"X400mm	7,60 €	8,44 €	1	5
BZ1X500	1"X500mm	7,83 €	8,69 €	1	5
BZ1X1000	1"X1000mm	10,22 €	11,35 €	1	5

Barilotto Zincato 1 1/4"X10 Cm.

Codice	Riferimenti	Listino A	Listino B	Off.	Box
BZ11\4X100	1 1/4"X100mm	1,62 €	1,80 €	1	5
BZ11\4X150	1 1/4"X150mm	2,18 €	2,42 €	1	5
BZ11\4X200	1 1/4"X200mm	3,87 €	4,29 €	1	5
BZ11\4X250	1 1/4"X250mm	3,64 €	4,04 €	1	5
BZ11\4X300	1 1/4"X300mm	4,20 €	4,66 €	1	5
BZ11\4X400	1 1/4"X400mm	5,84 €	6,49 €	1	5
BZ11\4X500	1 1/4"X500mm	6,73 €	7,47 €	1	5



Tee Zincata 4 Vie F. 223
D.1/2"

[Visualizza la gamma completa](#)

Codice	Riferimenti	Listino A	Listino B	Off.	Box
TZ4V1/2	D. 1/2"	3,44 €	3,82 €	1	5
TZ4V3/4	D. 3/4"	4,30 €	4,77 €	1	5
TZ4V1	D. 1"	6,35 €	7,05 €	1	5



Croce Zincata Fig. 180

Codice	Riferimenti	Listino A	Listino B	Off.	Box
CZ1/2	D. 1/2"	2,63 €	2,92 €	1	5
CZ3/4	D. 3/4"	3,95 €	4,38 €	1	5
CZ1	D. 1"	4,88 €	5,42 €	1	5
CZ11/4	D. 1 1/4"	6,55 €	7,27 €	1	5



Barilotto Zincato Cm.
1/2"X15 Prolungato "
Scorrevole "

Codice	Riferimenti	Listino A	Listino B	Off.	Box
BZ1\2X150P	1/2"X150mm	1,21 €	1,35 €	1	5
BZ1\2X200P	1/2"X200mm	1,57 €	1,74 €	1	5
BZ3\4X150P	3/4"X150mm	1,57 €	1,74 €	1	5
BZ3\4X200P	3/4"X200mm	1,59 €	1,76 €	1	5
BZ1X150P	1"X150mm	2,13 €	2,36 €	1	5
BZ1X200P	1"X200mm	2,88 €	3,20 €	1	5
BZ11\4X150P	1 1/4"X150mm	2,96 €	3,29 €	1	5
BZ11\4X200P	1 1/4"X200mm	3,82 €	4,24 €	1	5
BZ11\2X150P	1 1/2"X150mm	3,44 €	3,82 €	1	5
BZ11\2X200P	1 1/2"X200mm	4,55 €	5,06 €	1	5
BZ2X150P	2"X150mm	4,83 €	5,36 €	1	5
BZ2X200P	2"X200mm	6,02 €	6,68 €	1	5



Valvola Sfera P /T Leva



Codice	Riferimenti	Listino A	Listino B	Off.	Box
VS1\2	1/2" FF	5,75 €	6,38 €	1	10
VS3\4	3/4" FF	8,69 €	9,65 €	1	10
VS1	1" FF	14,40 €	15,98 €	1	8
VS11\4	1"1/4 FF	21,84 €	24,25 €	1	6
VS11\2	1"1/2 FF	31,74 €	35,23 €	1	4
VS2	2" FF	53,33 €	59,19 €	1	2



Valvola Sfera MF
Leva Rossa



Codice	Riferimenti	Listino A	Listino B	Off.	Box
VS1\2MF	1/2" MF	5,75 €	6,38 €	1	10
VS3\4MF	3/4" MF	8,52 €	9,46 €	1	10
VS1MF	1" MF	14,65 €	16,26 €	1	8
VS11\4MF	1"1/4 MF	22,94 €	25,46 €	1	6
VS11\2MF	1"1/2 MF	31,20 €	34,63 €	1	4
VS2MF	2" MF	53,33 €	59,19 €	1	2



Valvola 1/2" Ff A
Farfalla

Codice	Riferimenti	Listino A	Listino B	Off.	Box
VS1\2F	1/2" FF	5,75 €	6,38 €	1	10
VS3\4F	3/4" FF	8,52 €	9,46 €	1	10
VS1F	1" FF	14,41 €	16,00 €	1	8



Valvola 1/2" Mf A
Farfalla

Codice	Riferimenti	Listino A	Listino B	Off.	Box
VS1\2FMF	1/2" MF	6,41 €	7,12 €	1	10
VS3\4FMF	3/4" MF	8,68 €	9,63 €	1	10
VS1FMF	1" MF	14,65 €	16,26 €	1	8



Valvola Ad Angolo Mf



Codice	Riferimenti	Listino A	Listino B	Off.	Box
VA1\2	1/2" MF	8,87 €	9,85 €	1	10
VA3\4	3/4" MF	14,00 €	15,54 €	1	10
VA1	1" MF	22,75 €	25,25 €	1	8



Valvola Bocchettone Mf



Codice	Riferimenti	Listino A	Listino B	Off.	Box
VB1\2	1/2" MF	6,92 €	7,68 €	1	10
VB3\4	3/4" MF	11,28 €	12,52 €	1	10
VB1	1" MF	19,15 €	21,25 €	1	8



Valvola Tenuta Apm



Codice	Riferimenti	Listino A	Listino B	Off.	Box
VE1\2A	1/2"	6,31 €	7,00 €	1	10
VE3\4A	3/4"	10,42 €	11,57 €	1	10
VE1A	1"	15,85 €	17,59 €	1	8
VE11\4A	1"1/4	22,51 €	24,98 €	1	6



Valvola Clapet



Codice	Riferimenti	Listino A	Listino B	Off.	Box
VC1\2	1/2"	5,31 €	5,90 €	1	10
VC3\4	3/4"	7,59 €	8,43 €	1	10
VC1	1"	12,31 €	13,66 €	1	8
VC11\4	1"1/4	18,83 €	20,90 €	1	6



Valvola Tenuta Planet

Codice	Riferimenti	Listino A	Listino B	Off.	Box
VT1\2P	1/2"	3,93 €	4,37 €	1	10
VT3\4P	3/4"	5,18 €	5,75 €	1	10
VT1P	1"	8,08 €	8,97 €	1	8
VT11\4P	1"1/4	11,13 €	12,36 €	1	6



Filtro Raccogli
Impurita'

Codice	Riferimenti	Listino A	Listino B	Off.	Box
FY1\2	1/2"	3,79 €	4,21 €	1	10
FY3\4	3/4"	7,19 €	7,98 €	1	10
FY1	1"	9,44 €	10,47 €	1	8
FY11\4	1"1/4	17,28 €	19,18 €	1	6



Rubinetto Sfera Pes. Leva
1/2''' Blu

Codice	Riferimenti	Listino A	Listino B	Off.	Box
RS1\2P	1/2"	9,60 €	10,65 €	1	1
RS3\4P	3/4"	12,60 €	13,98 €	1	1



Rubinetto Sfera Pes. 1/2'''
Leva Alluminio Nera

Codice	Riferimenti	Listino A	Listino B	Off.	Box
2050N015	1/2"	8,24 €	9,15 €	1	1



Rubinetto A Sfera Da 1/2'''

Codice	Riferimenti	Listino A	Listino B	Off.	Box
RS1\2	1/2"	5,21 €	5,78 €	1	1
RS3\4	3/4"	8,19 €	9,10 €	1	1
RS1	1"	13,85 €	15,37 €	1	1



Rubinetto A Sfera
C/Portagomma Asta Piatta
1/2'''

Codice	Riferimenti	Listino A	Listino B	Off.	Box
2060ST015	1/2"	5,76 €	6,39 €	1	1
2060ST020	3/4"	8,13 €	9,02 €	1	1
2060ST025	1"	14,08 €	15,63 €	1	1



Rubinetto A Sfera Doppio
Portagomma

Codice	Riferimenti	Listino A	Listino B	Off.	Box
2040ST015	1/2"	12,83 €	14,24 €	1	1



Rubinetto A Sfera 1/2''' P
/Lucch.

Codice	Riferimenti	Listino A	Listino B	Off.	Box
RS1\2L	1/2"	7,53 €	8,36 €	1	1
RS3\4L	3/4"	8,90 €	9,88 €	1	1



Rubinetto G. Da 1/2'' Lucido
CON PORTAGOMMA

Codice	Riferimenti	Listino A	Listino B	Off.	Box
RGP1\2	1/2"	17,56 €	19,49 €	1	1



Portagomma X Rubinetto
3/4'''X1/2'''

Codice	Riferimenti	Listino A	Listino B	Off.	Box
PR1\2	1/2"	1,34 €	1,49 €	1	1
PR3\4	3/4"	2,46 €	2,73 €	1	1



Rubinetto Giallo C /Estr. Port.

Codice	Riferimenti	Listino A	Listino B	Off.	Box
RGCE1\2	1/2"	10,53 €	11,68 €	1	1



Valvola Mignon D. 1/2'' Mf
L/Nera

Codice	Riferimenti	Listino A	Listino B	Off.	Box
VM1\2N	D. 1/2"	4,24 €	4,70 €	1	1
VM3\8	D. 3/8"	2,71 €	3,01 €	1	1



Valvola Mignon 1/2'' Cr.
Esag.Mf

Codice	Riferimenti	Listino A	Listino B	Off.	Box
VM1\2BN		4,27 €	4,74 €	1	1
VM1\2FBN		3,61 €	4,01 €	1	1



Valvola Mignon Ff 1/2''
L/Nera

Codice	Riferimenti	Listino A	Listino B	Off.	Box
VM1\2FN	D. 1/2"	3,74 €	4,15 €	1	1
VM3\8F	D. 3/8"	2,97 €	3,30 €	1	1



Valvola Gas 1/2" Mf Piatta
Bu

Codice	Riferimenti	Listino A	Listino B	Off.	Box
VSG1\2PMF	D. 1/2"	8,01 €	8,90 €	1	1
VSG3\4PMF	D. 3/4"	11,85 €	13,16 €	1	1
VSG1PMF	D. 1"	18,39 €	20,41 €	1	1
VSG11\4PMF	D. 1 1/4"	23,74 €	26,35 €	1	1
VSG11\2PMF	D. 1 1/2"	29,65 €	32,91 €	1	1
VSG2PMF	D. 2"	51,42 €	57,08 €	1	1



Valvola A Sfera Gas 1/2"
Piatta

Codice	Riferimenti	Listino A	Listino B	Off.	Box
VSG1\2P	D. 1/2"	7,63 €	8,47 €	1	1
VSG3\4P	D. 3/4"	11,51 €	12,78 €	1	1
VSG1P	D. 1"	18,39 €	20,41 €	1	1
VSG11\4P	D. 1 1/4"	23,74 €	26,35 €	1	1
VSG11\2P	D. 1 1/2"	29,65 €	32,91 €	1	1
VSG2P	D. 2"	51,42 €	57,08 €	1	1



Valvola Gas Farfalla 1/2" Mf

Codice	Riferimenti	Listino A	Listino B	Off.	Box
VSG1\2FMF	D. 1/2"	8,01 €	8,90 €	1	1
VSG3\4FMF	D. 3/4"	11,85 €	13,16 €	1	1
VSG1FMF	D. 1"	18,39 €	20,41 €	1	1



Valvola Sfera Gas 1/2" Far.
Bug

Codice	Riferimenti	Listino A	Listino B	Off.	Box
VSG1\2F	D. 1/2"	7,63 €	8,47 €	1	1
VSG3\4F	D. 3/4"	11,51 €	12,78 €	1	1
VSG1F	D. 1"	19,61 €	21,77 €	1	1



Valvola Gas 1/2" Farfalla
Presa Pressione

Codice	Riferimenti	Listino A	Listino B	Off.	Box
VSG1\2FPPP	D. 1/2"	16,25 €	18,04 €	1	1
VSG3\4FPPP	D. 3/4"	23,32 €	25,89 €	1	1
VSG1FPPP	D. 1"	33,09 €	36,73 €	1	1



Rubinetto Gas Sq.
1/2" Mx1/2" F

Codice	Riferimenti	Listino A	Listino B	Off.	Box
RGSMFDD	1/2"x1/2"	7,70 €	8,55 €	1	1
RGSMFDG	1/2"x3/4"	11,61 €	12,89 €	1	1



Rubinetto Gas Sq. Mm.
1/2"

Codice	Riferimenti	Listino A	Listino B	Off.	Box
RGSMM	D. 1/2"	7,59 €	8,43 €	1	1



Rubinetto Gas Sq. 1/2" M.
Met.

Codice	Riferimenti	Listino A	Listino B	Off.	Box
RGS1\2MET	1/2" metano	6,05 €	6,71 €	1	1



Contatore Gas Cl.G2,5
Gpl.Met

Codice	Riferimenti	Listino A	Listino B	Off.	Box
CG2,5	max 4 lt/h	78,44 €	87,06 €	1	1



Rubinetto Sq. M. 1/2" Xgpl

Codice	Riferimenti	Listino A	Listino B	Off.	Box
RGS1\2GPL	1/2" gpl	6,30 €	6,99 €	1	1



Coppia Mensola C /Valv. Cont.
1 1/4" Attacco Contatore Uscita 3/4"
M Entrata 3/4" F

Codice	Riferimenti	Listino A	Listino B	Off.	Box
CMCG	3/4"x1 1/4"	29,98 €	33,28 €	1	1



Guarnizione Gpl Cuio 17X10X2

Codice	Riferimenti	Listino A	Listino B	Off.	Box
5020CUOIO	17x10x2	0,03 €	0,04 €	1	1



Nuovo Tubo Gas Rivestito 100Mm

Codice	Riferimenti	Listino A	Listino B	Off.	Box
EMITEG100	cm.100	12,15 €	13,48 €	1	1
EMITEG150	cm.150	17,33 €	19,24 €	1	1
EMITEG200	cm.200	21,00 €	23,31 €	1	1
EMITEG300	cm.300	34,66 €	38,48 €	1	1



Flex Acqua Mf Da 1/2" 110/210

Codice	Riferimenti	Listino A	Listino B	Off.	Box
FA1\220	1/2" 10<->20	5,24 €	5,81 €	1	1
FA1\240	1/2" 20<->40	6,20 €	6,88 €	1	1
FA3\420	3/4" 10<->20	7,29 €	8,09 €	1	1
FA3\440	3/4" 20<->40	9,24 €	10,25 €	1	1

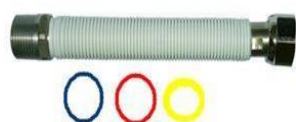

Flex Riv. Bianco 10-20 1/2"

Codice	Riferimenti	Listino A	Listino B	Off.	Box
GA1201B	1/2" 10<->20	6,15 €	6,82 €	1	1
GA1202B	1/2" 20<->40	7,08 €	7,86 €	1	1
GA3401B	3/4" 10<->20	8,53 €	9,46 €	1	1
GA3402B	3/4" 20<->40	9,31 €	10,34 €	1	1



Valvola Con Cassetta Gas Ispezione 1/2" F

Codice	Riferimenti	Listino A	Listino B	Off.	Box
CGI1\2CR	1/2" FF	48,65 €	54,00 €	1	1
CGI3\4CR	3/4" MM	42,19 €	46,83 €	1	1



Ecogiunto Retto Per Gas 3/4" Pe 25

Codice	Riferimenti	Listino A	Listino B	Off.	Box
034000/G	D. 3/4"	26,42 €	29,32 €	1	1
034001/G	D. 1"	27,33 €	30,33 €	1	1
034002/G	D. 1 1/4"	31,43 €	34,88 €	1	1
034003/G	D. 1 1/2"	36,43 €	40,44 €	1	1
034004/G	D. 2"	40,08 €	44,49 €	1	1



Tubo Gas Estensibile Autoest. D. 20 Mm

Codice	Riferimenti	Listino A	Listino B	Off.	Box
TGAS20E	D. 20	0,73 €	0,81 €	1	1
TGAS25E	D. 25	0,81 €	0,89 €	1	1
TGAS30E	D. 30	0,98 €	1,09 €	1	1
TGAS40E	D. 40	1,59 €	1,77 €	1	1



Flex Gas Estensibile Gas D. 1/2" 100<->200

Codice	Riferimenti	Listino A	Listino B	Off.	Box
FG1\220	1/2" 10<->20	6,27 €	6,97 €	1	1
FG1\240	1/2" 20<->40	7,29 €	8,09 €	1	1
FG3\420	3/4" 10<->20	8,70 €	9,66 €	1	1
FG3\440	3/4" 20<->40	10,58 €	11,75 €	1	1



Kit Caldaia Universale 5 Pz 10<->20 Cm.

Codice	Riferimenti	Listino A	Listino B	Off.	Box
KC	Kit 10 <-> 20	40,99 €	45,50 €	1	1
KCP	Kit 20 <-> 40	37,73 €	41,87 €	1	1

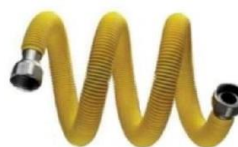

Flex Gas 75-150 Ff 1/2"

Codice	Riferimenti	Listino A	Listino B	Off.	Box
FG150	75<->150	15,92 €	17,67 €	1	1



Ecogiunto Curvo Per Gas 3/4" Pe 25

Codice	Riferimenti	Listino A	Listino B	Off.	Box
034020/G	D. 3/4"	45,54 €	50,55 €	1	1
034021/G	D. 1"	51,01 €	56,62 €	1	1
034022/G	D. 1 1/4"	63,76 €	70,77 €	1	1
034023/G	D. 1 1/2"	68,32 €	75,83 €	1	1
034024/G	D. 2"	84,71 €	94,03 €	1	1



Minicentralina Per 2 Bombole Modello Y + Reg Bp 4Kg Con Manometro E Riduttori Di 1° E 2° Stadio (Completa Di Staffa E Tasselli) Con Membrana In Viton + Fless

Codice	Riferimenti	Listino A	Listino B	Off.	Box
MC230212F	2 vie 4 KG	73,38 €	81,45 €	1	4



Riduttore Primo Stadio In Alluminio Per Serbatoi Gpl Interrati E Fuori Terra Ad Uso Domestico Ed Industriale Portata 40-60 Kg/H C/Manometro P.E. 16 Bar Max 1/4" F - 3/8" F (P.U. = 1-3 Bar)

Codice	Riferimenti	Listino A	Listino B	Off.	Box
RGAP40M	40-60 kg	50,60 €	56,17 €	1	6



Riduttore Pressione 12-14 Kg/H

Codice	Riferimenti	Listino A	Listino B	Off.	Box
RGAP14M	14 kg	25,81 €	28,65 €	1	6



Regolatore Gas Alta Pressione Pesante

Codice	Riferimenti	Listino A	Listino B	Off.	Box
AP02100XZ		52,63 €	58,42 €	1	6



Regolatore 7Kg. Bp F.3/8"

Codice	Riferimenti	Listino A	Listino B	Off.	Box
RG7C	7 kg	18,22 €	20,22 €	1	6
RG10C	10 kg	19,23 €	21,34 €	1	6



Regolatore Bassa Press. Variab

Codice	Riferimenti	Listino A	Listino B	Off.	Box
RGBPV	bp	3,88 €	4,30 €	1	12



Tubo Pvc X Gas Bombole Gpl 8X13 Imq rotolo Mt. 50

Codice	Riferimenti	Listino A	Listino B	Off.	Box
TGGPL	D. 13x8	1,13 €	1,25 €	1	50



Minicentralina Gas 2 V. Reg. 4 Kg. Con Flessibili

Codice	Riferimenti	Listino A	Listino B	Off.	Box
MCG24F	2 vie	39,22 €	43,53 €	1	4



Riduttore Primo Stadio In Alluminio Per Serbatoi Gpl Interrati E Fuori Terra Ad Uso Domestico Ed Industriale Portata 40-60 Kg/H S/Manometro P.E. 16 Bar Max 1/4" F - 3/8" F (P.U. = 1-3 Bar)

Codice	Riferimenti	Listino A	Listino B	Off.	Box
RGAP40	40-60 kg	43,77 €	48,59 €	1	6



Regolatore Alta Pressione

Codice	Riferimenti	Listino A	Listino B	Off.	Box
RGAP		8,10 €	8,99 €	1	12



Ridutt. Aprn 40 Kg. 0 /3 Bar Con Manometro

Codice	Riferimenti	Listino A	Listino B	Off.	Box
RAP40M	40 kg	50,60 €	56,17 €	1	6



Regolatore Gas 4 Kg Entrata Dado Ch25 Uscita G 3/8 F

Codice	Riferimenti	Listino A	Listino B	Off.	Box
RG4CD	4 kg	9,87 €	10,95 €	1	6



Regolatore Gas Bassa Pressione

Codice	Riferimenti	Listino A	Listino B	Off.	Box
RGBP	bp	5,44 €	6,04 €	1	12



Tubo Pvc X Gas Metano 13X20 Imq rotolo Mt. 50

Codice	Riferimenti	Listino A	Listino B	Off.	Box
TGM	D. 20x13	1,87 €	2,08 €	1	50



Gomito M. 1/2" X Gpl

Codice	Riferimenti	Listino A	Listino B	Off.	Box
GM1\2G	Gpl	2,13 €	2,36 €	1	10



Gomito F. 1/2" X Gpl

Codice	Riferimenti	Listino A	Listino B	Off.	Box
GF1\2G	Gpl	1,91 €	2,12 €	1	10



Gomito M. 1/2" X Met.

Codice	Riferimenti	Listino A	Listino B	Off.	Box
GM1\2M	Metano	2,55 €	2,83 €	1	10



Gomito F. 1/2" X Met.

Codice	Riferimenti	Listino A	Listino B	Off.	Box
GF1\2M	Metano	2,23 €	2,48 €	1	10



Niples Femmina
1/2"X10 Gpl

Codice	Riferimenti	Listino A	Listino B	Off.	Box
NF1\2G	Gpl	1,47 €	1,63 €	1	10



Niples Femmina
1/2"X14 Met

Codice	Riferimenti	Listino A	Listino B	Off.	Box
NF1\2M	Metano	2,91 €	3,23 €	1	10



Niples Maschio
1/2"X10 Gpl

Codice	Riferimenti	Listino A	Listino B	Off.	Box
NM1\2G		1,26 €	1,40 €	1	10



Niples Maschio
1/2"X14 Met

Codice	Riferimenti	Listino A	Listino B	Off.	Box
NM1\2M		1,32 €	1,46 €	1	10



Raccordo A Gomito G
1/2" M-M

Codice	Riferimenti	Listino A	Listino B	Off.	Box
RG110001	1/2"	1,67 €	1,85 €	1	10



Raccordo A Gomito G 1/2"
M-F Port. A 90° - Ø 14
Metano Con Filetto
Maschio, In Zama

Codice	Riferimenti	Listino A	Listino B	Off.	Box
RG100001	1/2"	1,72 €	1,91 €	1	10



Niples Gialla 1/2" Ds Sx

Codice	Riferimenti	Listino A	Listino B	Off.	Box
NG1\2DD	1/2" Dx-Dx	1,87 €	2,08 €	1	10
NG1\2DS	1/2" Dx-Sx	4,43 €	4,91 €	1	10



Raccordo A "Y" Gpl

Codice	Riferimenti	Listino A	Listino B	Off.	Box
RYMET	Metano	3,80 €	4,21 €	1	10
RYGPL	Gpl	0,96 €	1,07 €	1	10



Port. A 90° - Ø 14 Metano
Con Filetto Maschio, In
Zama G 1/2" MØ 1/8" F

Codice	Riferimenti	Listino A	Listino B	Off.	Box
PG911406	1/2"	1,77 €	1,97 €	1	10



Raccordo M.1/4" Dado
Mm 25

Codice	Riferimenti	Listino A	Listino B	Off.	Box
147.010		2,45 €	2,72 €	1	10



Tubo Multistrato "373"
Rivestito



TM16X2EB
TM20X2EB
TM26X3EB
TM32X3EB



TM16X2ER
TM20X2ER
TM26X3ER
TM32X3ER

Codice	Riferimenti	Listino A	Listino B	Off.	Mt
TM16X2E	16X2X0,2	1,80 €	2,00 €	1	50
TM20X2E	20X2X0,2	2,07 €	2,29 €	1	50
TM26X3E	26X3X0,3	5,03 €	5,59 €	1	2
TM32X3E	32X3X0,3	8,47 €	9,40 €	1	25



Tubo Multistrato Pex 16X2



PROMO

Codice	Riferimenti	Listino A	Listino B	Off.	Mt
TM16X2	16X2X0,2	1,27 €	1,41 €	1	100
TM20X2	20X2X0,2	1,62 €	1,80 €	1	100
TM26X3	26X3X0,3	3,11 €	3,45 €	1	50
TM32X3	32X3X0,3	4,76 €	5,28 €	1	25



Collettore Inclinato D. 3/4"
MF uscita 1/2" M tasca D. 16

Codice	Riferimenti	Listino A	Listino B	Off.	Box
CI2A	2 vie	9,36 €	10,38 €	1	12
CI3A	3 vie	14,04 €	15,58 €	1	12
CI4A	4 vie	18,71 €	20,77 €	1	12
CI5A	5 vie	21,33 €	23,68 €	1	12



Tubo Multistrato "373"
Rivestito Gas

Codice	Riferimenti	Listino A	Listino B	Off.	Mt
TM16X2G	16X2X0,3	3,03 €	3,36 €	1	50
TM20X2G	20X2X0,4	4,01 €	4,45 €	1	50
TM26X3G	26X3X0,6	7,49 €	8,32 €	1	25



Collettore Angolo D. 3/4" MF
uscita 1/2" M tasca D. 16

Codice	Riferimenti	Listino A	Listino B	Off.	Box
C1\212	2 vie	14,41 €	15,99 €	1	12
C1\213	3 vie	21,61 €	23,99 €	1	12
C1\214	4 vie	28,81 €	31,98 €	1	12



Tubo Multistrato "373"
Rivestito Refrigerazione

Codice	Riferimenti	Listino A	Listino B	Off.	Mt
TM16X2EF	16X2-Isolante 13	2,46 €	2,73 €	1	50
TM20X2EF	20X2-Isolante 13	2,91 €	3,23 €	1	50
TM26X3EF	26X3-Isolante 13	5,18 €	5,75 €	1	25
TM32X3EF	32X3-Isolante 13	9,08 €	10,08 €	1	25



Collettore senza chiusura
3/4" MF uscita 1/2" M tasca
D. 16

Codice	Riferimenti	Listino A	Listino B	Off.	Box
CS2V3\4X1\2	2 vie	5,82 €	6,46 €	1	12
CS3V3\4X1\2	3 vie	8,73 €	9,69 €	1	12
CS4V3\4X1\2	4 vie	11,64 €	12,92 €	1	12

Collettore MF 1" Uscita D. 1/2"

Codice	Riferimenti	Listino A	Listino B	Off.	Box
CS2V1X1\2	2 vie	9,65 €	10,71 €	1	12
CS3V1X1\2	3 vie	12,61 €	14,00 €	1	12
CS4V1X1\2	4 vie	15,15 €	16,82 €	1	12

Collettore MF 1 1/4" Uscita D. 1/2"

Codice	Riferimenti	Listino A	Listino B	Off.	Box
CS2V11\4X1\2	2 vie	13,12 €	14,56 €	1	12
CS3V11\4X1\2	3 vie	18,79 €	20,86 €	1	12
CS4V11\4X1\2	4 vie	24,48 €	27,17 €	1	12



Raccordo Retto Quick per
attacco rapido multistrato

Codice	Riferimenti	Listino A	Listino B	Off.	Box
RQ16B	D. 16	1,49 €	1,66 €	1	24
RQ20R	D. 20	2,28 €	2,53 €	1	24



Cassette per Collettori

Codice	Riferimenti	Listino A	Listino B	Off.	Box
C3024	300X240X80	14,97 €	16,62 €	1	24
C4024	400X240X80	17,70 €	19,64 €	1	24
C5024	500X240X80	20,42 €	22,66 €	1	24
C6024	600X240X80	21,78 €	24,18 €	1	24



Nipples Maschio Mult.
1/2"X16X2,0

Codice	Riferimenti	Listino A	Listino B	Off.	Box
NM1\2X16M	1/2"x16	1,85 €	2,05 €	1	10
NM1\2X20M	1/2"x20	3,37 €	3,74 €	1	10
NM3\4X16M	3/4"x16	3,07 €	3,41 €	1	5
NM3\4X20M	3/4"x20	3,40 €	3,77 €	1	5



Niplo F. Nich.
Mult.1/2"X16X2,0

Codice	Riferimenti	Listino A	Listino B	Off.	Box
NF1\2X16M	1/2"x16	2,00 €	2,22 €	1	10
NF1\2X20M	1/2"x20	3,32 €	3,68 €	1	10
NF3\4X16M	3/4"x16	2,53 €	2,81 €	1	5
NF3\4X20M	3/4"x20	4,07 €	4,51 €	1	5



Nipples Doppia 16 Multistrato

Codice	Riferimenti	Listino A	Listino B	Off.	Box
ND16M	16x16	2,98 €	3,31 €	1	10
ND20M	20x20	4,14 €	4,60 €	1	10
ND26M	26x26	6,07 €	6,74 €	1	5
ND32M	32x32	15,38 €	17,07 €	1	5



Gomito Doppio 16
Multistrato

Codice	Riferimenti	Listino A	Listino B	Off.	Box
GD16M	16x16	3,34 €	3,71 €	1	10
GD20M	20x20	5,43 €	6,02 €	1	10
GD26M	26x26	8,25 €	9,16 €	1	5
GD32M	32x32	14,21 €	15,77 €	1	5



Gomito F. 1/2"X20
Multistrato

Codice	Riferimenti	Listino A	Listino B	Off.	Box
GF1\2X16M	1/2"x16	2,47 €	2,74 €	1	10
GF1\2X20M	1/2"x20	4,12 €	4,57 €	1	10
GF3\4X16M	3/4"x16	3,51 €	3,90 €	1	5
GF3\4X20M	3/4"x20	4,69 €	5,21 €	1	5



Gomito Maschio 1/2"X20
Mult.

Codice	Riferimenti	Listino A	Listino B	Off.	Box
GM1\2X16M	1/2"x16	2,51 €	2,79 €	1	10
GM1\2X20M	1/2"x20	4,03 €	4,48 €	1	10
GM3\4X16M	3/4"x16	2,61 €	2,90 €	1	5
GM3\4X20M	3/4"x20	4,62 €	5,13 €	1	5



Tee Tre Vie Multistrato 16X2

Codice	Riferimenti	Listino A	Listino B	Off.	Box
T16M	16x16	4,95 €	5,49 €	1	10
T20M	20x20	7,27 €	8,07 €	1	10
T26M	26x26	11,87 €	13,18 €	1	5
T32M	32x32	15,51 €	17,22 €	1	5



Inserti X Multistrato Da 16X2

Codice	Riferimenti	Listino A	Listino B	Off.	Box
I16M	16x1/2	1,42 €	1,57 €	1	25



Gomito Flangiato 1/2"X16
Mult

Gomito Flangiato 1/2"X16

Codice	Riferimenti	Listino A	Listino B	Off.	Box
GFL1\2X16M	1/2"x16	3,42 €	3,80 €	1	10
GFL1\2X20M	1/2"x20	5,32 €	5,91 €	1	10



Tee Femmina Multistrato
D. 16X1/2"X16X2,0

Tee Femmina Multistrato

Codice	Riferimenti	Listino A	Listino B	Off.	Box
TF1\2X16M	16x1/2x16	3,92 €	4,35 €	1	10
TF1\2X20M	20x1/2x20	6,21 €	6,89 €	1	10
TF3\4X20M	20x3/4x20	7,03 €	7,80 €	1	5
TF3\4X26M	26x3/4x26	10,94 €	12,14 €	1	5



Niplo Maschio 1/2"X16Press.

Codice	Riferimenti	Listino A	Listino B	Off.	Box
NM1\2X16MP	1/2"x16	2,51 €	2,79 €	1	10
NM1\2X20MP	1/2"x20	3,37 €	3,74 €	1	10
NM3\4X16MP	3/4"x16	2,85 €	3,16 €	1	5
NM3\4X20MP	3/4"x20	3,91 €	4,34 €	1	5



Niples F. 1/2"X16 M. Press.

Codice	Riferimenti	Listino A	Listino B	Off.	Box
NF1\2X16MP	1/2"x16	2,63 €	2,92 €	1	10
NF1\2X20MP	1/2"x20	1,71 €	1,90 €	1	10
NF3\4X16MP	3/4"x16	2,73 €	3,03 €	1	5
NF3\4X20MP	3/4"x20	3,30 €	3,66 €	1	5



Niplo Doppio 16 Press.

Codice	Riferimenti	Listino A	Listino B	Off.	Box
ND16MP	16x16	2,35 €	2,61 €	1	10
ND20MP	20x20	3,08 €	3,42 €	1	10
ND26MP	26x26	3,94 €	4,37 €	1	5
ND32MP	32x32	5,82 €	6,46 €	1	5



Gomito Doppio D. 16 M.Press.

Codice	Riferimenti	Listino A	Listino B	Off.	Box
GD16MP	16x16	1,71 €	1,90 €	1	10
GD20MP	20x20	4,24 €	4,71 €	1	10
GD26MP	26x26	9,51 €	10,55 €	1	5
GD32MP	32x32	11,64 €	12,92 €	1	5



Gomito Multist.Pinz. 1/2"X16

Codice	Riferimenti	Listino A	Listino B	Off.	Box
GF1\2X16MP	1/2"x16	2,59 €	2,87 €	1	10
GF1\2X20MP	1/2"x20	3,35 €	3,72 €	1	10
GF3\4X16MP	3/4"x16	3,52 €	3,90 €	1	10
GF3\4X20MP	3/4"x20	4,41 €	4,89 €	1	10



Gomito M. 1/2"X16 M. Press.

Codice	Riferimenti	Listino A	Listino B	Off.	Box
GM1\2X16MP	1/2"x16	3,24 €	3,60 €	1	10
GM1\2X20MP	1/2"x20	3,29 €	3,65 €	1	10
GM3\4X16MP	3/4"x16	3,42 €	3,79 €	1	10
GM3\4X20MP	3/4"x20	5,29 €	5,87 €	1	10



Tee D. 16 Mul. Pinsare

Codice	Riferimenti	Listino A	Listino B	Off.	Box
T16MP	16x16	4,26 €	4,72 €	1	10
T20MP	20x20	4,69 €	5,21 €	1	10
T26MP	26x26	8,23 €	9,14 €	1	10
T32MP	32x32	9,65 €	10,71 €	1	10



Niples F. 1/2"X16 Gir. Mp

Codice	Riferimenti	Listino A	Listino B	Off.	Box
NF1\2X16GMP	1/2"x16	5,46 €	6,06 €	1	10
NF3\4X16GMP	1/2"x20	6,09 €	6,76 €	1	10



Gomito Flang.1/2"X16 Mul.Pre.

Codice	Riferimenti	Listino A	Listino B	Off.	Box
GFL1\2X16MP	1/2"x16	3,12 €	3,47 €	1	10
GFL1\2X20MP	1/2"x20	3,61 €	4,01 €	1	10



Tee F. 1/2"X16 Mul. Press.

Codice	Riferimenti	Listino A	Listino B	Off.	Box
TF1\2X16MP	16x1/2x16	4,74 €	5,26 €	1	10
TF1\2X20MP	20x1/2x20	6,13 €	6,81 €	1	10
TF3\4X20MP	20x3/4x20	6,12 €	6,79 €	1	10
TF3\4X26MP	26x3/4x26	7,99 €	8,87 €	1	10



Nipples M 1/2"X20 Mult. Gas

Codice	Riferimenti	Listino A	Listino B	Off.	Box
NM1\2X16MPG	1/2"x16	3,06 €	3,40 €	1	10
NM1\2X20MPG	1/2"x20	3,67 €	4,07 €	1	10
NM3\4X16MPG	3/4"x16	Arrivo	Arrivo	1	10
NM3\4X20MPG	3/4"x20	4,13 €	4,59 €	1	10



Nipples F. 1/2"X20 Mult. Gas

Codice	Riferimenti	Listino A	Listino B	Off.	Box
NF1\2X16MPG	1/2"x16	2,54 €	2,82 €	1	10
NF1\2X20MPG	1/2"x20	3,21 €	3,56 €	1	10
NF3\4X16MPG	3/4"x16	Arrivo	Arrivo	1	10
NF3\4X20MPG	3/4"x20	3,21 €	3,56 €	1	10



Nipples Doppio Mult. Gas
20X20

Codice	Riferimenti	Listino A	Listino B	Off.	Box
ND16MPG	16x16	3,47 €	3,86 €	1	10
ND20MPG	20x20	4,85 €	5,39 €	1	10
ND26MPG	26x26	7,03 €	7,80 €	1	10
ND32MPG	32x32	Arrivo	Arrivo	1	10



Gomito Doppio 20 Mult. Gas

Codice	Riferimenti	Listino A	Listino B	Off.	Box
GD16MPG	16x16	3,43 €	3,81 €	1	10
GD20MPG	20x20	5,51 €	6,12 €	1	10
GD26MPG	26x26	7,16 €	7,94 €	1	10
GD32MPG	32x32	Arrivo	Arrivo	1	10



Gomito F. 1/2"X20 Mult. Gas

Codice	Riferimenti	Listino A	Listino B	Off.	Box
GF1\2X16MPG	1/2"x16	4,09 €	4,54 €	1	10
GF1\2X20MPG	1/2"x20	3,85 €	4,27 €	1	10
GF3\4X16MPG	3/4"x16	Arrivo	Arrivo	1	10
GF3\4X20MPG	3/4"x20	4,23 €	4,69 €	1	10



Gomito M. 1/2"X20 Mult. Gas

Codice	Riferimenti	Listino A	Listino B	Off.	Box
GM1\2X16MPG	1/2"x16	3,09 €	3,43 €	1	10
GM1\2X20MPG	1/2"x20	4,02 €	4,46 €	1	10
GM3\4X16MPG	3/4"x16	Arrivo	Arrivo	1	10
GM3\4X20MPG	3/4"x20	4,44 €	4,93 €	1	10



Tee 20 Mult. Gas

Codice	Riferimenti	Listino A	Listino B	Off.	Box
T16MPG	16x16	5,93 €	6,59 €	1	10
T20MPG	20x20	7,79 €	8,65 €	1	10
T26MPG	26x26	12,08 €	13,41 €	1	10



Nipples F. Girev. 3/4"X16 Mpg

Codice	Riferimenti	Listino A	Listino B	Off.	Box
NF1\2X16GMPG	1/2"x16	7,35 €	8,16 €	1	10
NF3\4X16GMPG	1/2"x20	7,73 €	8,58 €	1	10



Gomito Flang. F. 1/2"X20
Mpg

Codice	Riferimenti	Listino A	Listino B	Off.	Box
GFL1\2X16MPG	1/2"x16	4,91 €	5,45 €	1	10
GFL1\2X20MPG	1/2"x20	5,31 €	5,90 €	1	10



Tee F. 1/2"X20 Mult/ Gas

Codice	Riferimenti	Listino A	Listino B	Off.	Box
TF1\2X16MPG	16x1/2x16	5,11 €	5,67 €	1	10
TF1\2X20MPG	20x1/2x20	6,63 €	7,36 €	1	10
TF3\4X20MPG	20x3/4x20	7,51 €	8,34 €	1	10
TF3\4X26MPG	26x3/4x26	10,64 €	11,81 €	1	10



Gruppo Pressurizzazione Pressost. Digitali N. 2 Rb 150M



Gruppo Pressurizzazione Pressost. Digitali N. 2 Rb 200M



Elettropompe In Ghisa Periferica Hp. 0,5



Codice	Pz	Listino A	Listino B
PD2-RB150M	1	2059,57 €	2183,15 €

Codice	Pz	Listino A	Listino B
PD2-RB200M	1	2182,29 €	2313,23 €

Codice	Pz	Listino A	Listino B
PMF050	1	83,96 €	88,99 €
PMF050x5	5	78,08 €	82,76 €

Elettropompe Autodescante Ghisa Monogirante Hp. 0,8



Elettropompe Autodescante Ghisa Monogirante Hp. 1



Elettropompe Autodescante Inox Monogirante Hp. 1



Codice	Pz	Listino A	Listino B
GPIJTG0800AR	1	195,51 €	207,25 €
GPIJTG0800ARx5	5	181,83 €	192,74 €

Codice	Pz	Listino A	Listino B
GPIJTG1000AR	1	195,51 €	207,25 €
GPIJTG1000ARx5	5	181,83 €	192,74 €

Codice	Pz	Listino A	Listino B
GPVJTX0810	1	164,82 €	174,71 €

Elettropompa centrifughe multicellulari in ghisa hp 0,6



Elettropompa Autodescante In Ghisa Hp. 075



Elettropompa Autodescante In Ghisa Hp. 1



Codice	Pz	Listino A	Listino B
GPVRGM0600	0,60	164,75 €	174,63 €
GPVRGM0750	0,75	178,92 €	189,66 €
GPVRGM1000	1,00	220,75 €	233,99 €

Codice	Pz	Listino A	Listino B
MDM0750	1	341,58 €	362,07 €
MDM0750x2	2	223,54 €	236,95 €

Codice	Pz	Listino A	Listino B
MDM1000	1	354,23 €	375,48 €
MDM1000x2	2	247,07 €	261,90 €

Elettropompa Multicellulare Autodescante Sistema Venturi Hp. 0,6



Elettropompa Multicellulare Autodescante Sistema Venturi Hp. 0,9



Elettropompa Multicellulare Autodescante Sistema Venturi Hp. 1,2



Codice	Pz	Listino A	Listino B
GPIRMA0600AR	1	209,32 €	221,87 €
GPIRMA0600ARx2	2	194,66 €	206,34 €

Codice	Pz	Listino A	Listino B
GPIRMA0900/AR	1	234,62 €	248,69 €
GPIRMA0900/ARx2	2	218,19 €	231,29 €

Codice	Pz	Listino A	Listino B
GPIRMA1200AR	1	265,67 €	281,61 €
GPIRMA1200ARx2	2	247,07 €	261,90 €

REX 120-E MONO 1,2KW 230V 50HZ 15MT H07RNF



si consiglia il montaggio di una sfera in uscita i litri secondo il vostro impianto

REX 120 AUT MONO 1,2KW 230V 50HZ 15MT H07RNF



si consiglia il montaggio di una sfera in uscita i litri secondo il vostro impianto

Elettropompa Multicellulare Autodescante Sistema Venturi Hp. 1,6



Codice	Pz	Listino A	Listino B
RHP1202/E		302,38 €	320,53 €

Codice	Pz	Listino A	Listino B
RHP1202		247,86 €	262,73 €

Codice	Pz	Listino A	Listino B
GPIRMA1600AR	1	319,72 €	338,91 €
GPIRMA1600ARx2	2	303,74 €	321,96 €



Elettropompe Centrifughe Bigiranti



Codice	Riferimenti	Listino A	Listino B	Off.	Box
RBT1500	Hp. 1,5	351,95 €	373,07 €	1	1
RBT2000	Hp. 2,0	386,65 €	409,85 €	1	1
RBT3000	Hp. 3,0	401,53 €	425,62 €	1	1
RBT4000	Hp. 4,0	773,31 €	819,71 €	1	1

Elettropompa "PAL" è sistema automatico:

Elettropompa periferica autoadescente, Completa: vaso di espansione, pressostato, sensore di flusso, valvola di non ritorno, filtro. si avvia e si arresta automaticamente al momento dell'apertura e chiusura del rubinetto.

> PROTEZIONE MARCIA A SECCO È dotata di un controllo di flusso che arresta automaticamente la pompa in mancanza di acqua dopo 6 minuti. Successivamente farà 4 tentativi ad intervalli di 1-5-12-24 ore, avviandosi automaticamente per 2 minuti > PROTEZIONE ANTIGRIPPAGGIO In caso di mancato utilizzo si avvia automaticamente ogni 72 ore per un tempo di 8



G.P.V.
International



Codice	Riferimenti	Listino A	Listino B	Off.	Box
PAL0800	Hp. 0,8	183,41 €	194,42 €	1	1
PAL1000	Hp. 1	195,81 €	207,55 €	1	1
PAL1500	Hp. 1,5	381,70 €	404,60 €	1	1



Pompe Sommerse Per POZZI Da 4" Hp. 1,00

Codice	Riferimenti	Listino A	Listino B	Off.	Box
ST-13-21T	HP 2 Trifase	438,70 €	465,03 €	1	1
ST-13-16T	HP 1,5 Trifase	379,22 €	401,97 €	1	1
ST-13-16M	HP 1,5 Mono	381,70 €	404,60 €	1	1
ST-13-11M	HP 1,0 Mono	374,26 €	396,72 €	1	1

MONDIALJET 4"



Elettropompe Sommergibili Monoblocco Multistadio Verticali, Per Pozzi 4" Hp 1.5 230 Hz 50 Mt. 20H 05Vvf-Aut+C.B.

RED.MON1500/CB	1" 1/4	1,5	230	50 l/min	90 mt.
RED.MON1600/CB	1" 1/4	1,5	230	90 l/min	70 mt.

Codice	Riferimenti	Listino A	Listino B	Off.	Box
MJET150M	Hp. 1,5	433,75 €	459,77 €	1	1
MJET160M	Hp. 1,5	438,70 €	465,03 €	1	1



Elettropompe Sommergibili Monoblocco Multistadio Verticali, Per Pozzi 4" Hp 1.5 230 Hz 50 Mt. 20H 05Vvf-Aut+C.B.

Codice	Riferimenti	Listino A	Listino B	Off.	Box
RXY0800	Hp. 0,8	340,80 €	361,25 €	1	1
RXY1000	Hp. 1,0	394,09 €	417,74 €	1	1
RXY1200	Hp. 1,2	431,27 €	457,14 €	1	1
RXY1600	Hp. 1,8	495,71 €	525,45 €	1	1

Turbo J Man Mono 230V 50Hz Con Control Box

Codice	Hp	Listino A	Listino B
GPVTBJ1003CB	1	348,12 €	369,01 €
TBJ1803CB	1,8	441,63 €	468,13 €

Maxima-S 100 Aut Mono 1Hp 230V 50Hz 6Mt H0 7Rnf

Codice	Hp	Listino A	Listino B
VXS1000	1	203,89 €	216,12 €

Elettropompa 1Hp 230V 50Hz Q max 225 l/min H max 8mt

Codice	Hp	Listino A	Listino B
VXX0752	1	143,76 €	152,38 €

Cutter 200 Man Tri 2Hp 380V 50Hz 10Mt H0 7Rn

Codice	Hp	Listino A	Listino B
TRC2005		1417,83 €	1502,90 €
TRC3005		1563,27 €	1657,07 €

Tiger-R 80 Con Galleggianti 0,8Hp 230V 50Hz 5Mt H07Rn

Codice	Hp	Listino A	Listino B
TGR0800	0,8	279,41 €	296,17 €
TGR0900		310,96 €	329,62 €

Tiger 200F Dn50 Con Galleggiante Tri 2Hp 380V 50Hz 10 M H07Rnf

Codice	Hp	Listino A	Listino B
TGR2005F	2	852,70 €	903,86 €
TGR3005F	3	1365,19 €	1447,10 €



PRESS CONTROL



Codice	Riferimenti	Listino A	Listino B	Conf.	Box
PRESHYD		40,38 €	42,80 €	1	6

Galleggiante Elettrico Immersione 3Mt



Codice	Riferimenti	Listino A	Listino B	Conf.	Box
GEI03	mt. 03	14,68 €	15,56 €	1	12
GEI05	mt. 05	18,72 €	19,85 €	1	12
GEI07	mt. 07	23,28 €	24,67 €	1	12



Galleg.Mercury Blu
10A Per Fossa
Imhoff



Contenitore 3 Pz
9/34" D. 3/4"
Completo Di Rete
Lavabile



Contenitore
Doppio 9 3/4 cont.
Duplex

Codice	Rif.	Listino A	Listino B	Codice	Pz	Listino A	Listino B	Codice	Pz	Listino A	Listino B
MTMENBMC10	10 mt	93,62 €	99,23 €	C3G10+CRL10	1	31,86 €	31,86 €	10148012	3/4"	56,80 €	63,05 €
								10148002	1"	56,80 €	63,05 €



Kit Di Pressione
Espa Flussostato
Regolabile Max 10
Bar 416 Std



Staffa



Chiave Universale
X Contenitore

Codice	Pz	Listino A	Listino B	Codice	Pz	Listino A	Listino B	Codice	Pz	Listino A	Listino B
KIT01	1	48,46 €	51,37 €	10145606	1	4,14 €	4,59 €	CUF	1	3,08 €	3,42 €



Lowara Genyo 8A/F22
Sistema Di Comando Pr
Elettropompe
109120180



Cartuccia
F/Avvolto 9/34"
20Mc Nastro Al
Cotone



Cartuccia
Carb./Attivi
9/34"20

Codice	Pz	Listino A	Listino B	Codice	Pz	Listino A	Listino B	Codice	Pz	Listino A	Listino B
GENYO8A/F22	1	76,39 €	80,97 €	CFA1020	9"3/4 5"	3,64 €	3,86 €	CCA1020	9"3/4 5"	13,41 €	14,21 €
						Arrivo	Arrivo			Arrivo	Arrivo



Candeletta
Sondina 1/2"
Molpen



Cartuccia
R/Lavabile
9/34"250M



Cartuccia
S/Minerali 9/34"
20M

Codice	Pz	Listino A	Listino B	Codice	Pz	Listino A	Listino B	Codice	Pz	Listino A	Listino B
CS1\2	1	5,82 €	6,17 €	CRL10250	9"3/4 5"	9,71 €	10,30 €	CSM1020	9"3/4 5"	25,75 €	27,29 €
						Arrivo	Arrivo			Arrivo	Arrivo



Presscontrol Riparte 2,2 Bar

Codice PSD02 668

Presscontrol Riparte 1,5 Bar

Codice PSD01 616

PROMO

Codice	Riferimenti	Listino A	Listino B	Conf.	Box
PSD02		31,63 €	35,11 €	1	6
PSD02x6	Offertax6	30,68 €	30,68 €	6	6
PSD02x12	Offertax12	30,05 €	30,05 €	12	6
PSD02x24	Offertax24	29,41 €	29,41 €	24	6

Galleggiante Inglese Tipo Sicilia In Ottone



Sfere ordinare a parte

Codice	Riferimenti	Listino A	Listino B	Conf.	Box
GI1\2N	D. 1/2"	8,35 €	9,27 €	1	12
GI3\4N	D. 3/4"	8,86 €	9,83 €	1	12
GI1N	D. 1"	9,43 €	10,46 €	1	6

Galleggiante 5 Coppiglie



Sfere ordinare a parte

Codice	Riferimenti	Listino A	Listino B	Conf.	Box
G5C3\8	D. 3/8"	7,29 €	8,09 €	1	25
G5C1\2	D. 1/2"	11,31 €	12,55 €	1	25
G5C3\4P	D. 3/4"	13,66 €	15,17 €	1	10
G5C1	D. 1"	14,93 €	16,57 €	1	10
G5C11\4	D. 1 1/4"	31,02 €	34,43 €	1	5
G5C11\2	D. 1 1/2"	61,74 €	68,53 €	1	5
G5C2	D. 2"	35,68 €	39,61 €	1	2

Sfera galleggiante asta scorrevole



Codice	Riferimenti	Listino A	Listino B	Conf.	Box
SG120	120 Asta	1,52 €	1,69 €	1	50
SG150	150 Asta	2,48 €	2,76 €	1	25
SG180	180 Asta	3,39 €	3,76 €	1	10
SG220	220 Asta	6,71 €	7,45 €	1	5

Sfera Combi (per galleggianti t/inglesi, 5 coppiglie)



Codice	Riferimenti	Listino A	Listino B	Conf.	Box
SC120	120 combi	2,02 €	2,25 €	1	50
SC150	150 combi	3,29 €	3,65 €	1	25
SC180	180 combi	2,68 €	2,97 €	1	10

Alimentatore Luise Aria per Polmone Autoclave



Codice	Riferimenti	Listino A	Listino B	Conf.	Box
MINI	100-500	46,83 €	51,98 €	1	10
MIDI	200-2000	95,82 €	106,36 €	1	6
MAXI	1000-4000	96,66 €	107,30 €	1	4
SMAXI	200-2000	98,37 €	109,19 €	1	2
VRA	Valvolina	4,81 €	5,34 €	1	25

Alimentatore Amis Aria per Polmone Autoclave



Codice	Riferimenti	Listino A	Listino B	Conf.	Box
A750	24-750	32,49 €	36,06 €	1	10
A2000	1000-2000	38,56 €	42,80 €	1	4

Flex Alimentatore Luise Mini M.1/4" X F.1/2" Cm 70



Codice	Riferimenti	Listino A	Listino B	Conf.	Box
FABD700	Mini	6,83 €	6,83 €	1	12
FADG1000	Midi	15,94 €	15,94 €	1	12

Niples Forata per Flessibile Alimentatore



Codice	Riferimenti	Listino A	Listino B	Conf.	Box
NF1X1\4	1" - 1/4"	3,34 €	3,34 €	1	5
NF11\4X1\2	1 1/4 - 1/2"	5,04 €	5,04 €	1	5

Sistema di Pressione con Regolazione del minimo Max pressione 10 Bar



Codice	Riferimenti	Listino A	Listino B	Conf.	Box
KIT05	KIT05	85,57 €	85,57 €	1	6

Pressostato per pompa acqua da 1,4 - 2,8 Bar



Codice	Riferimenti	Listino A	Listino B	Conf.	Box
PC2	PMAT5M	6,96 €	7,38 €	1	10
PC210	PMAT5M10	6,61 €	7,01 €	10	10



Pressostati Square D 1,4-4,6

PROMO

Codice	Riferimenti	Listino A	Listino B	Conf.	Box
FSG-2	FSG-2	19,74 €	20,92 €	1	25
FSG-2x25	Offertax25	18,75 €	19,87 €	25	25



Indicatore Livello X Liquidi 5 Funzioni Senza Supporto

Codice	Riferimenti	Listino A	Listino B	Conf.	Box
ILL008		50,13 €	50,13 €	1	12

Sonda A Scalare In Acciaio 5 Posizioni + Massa



Codice	Riferimenti	Listino A	Listino B	Conf.	Box
SAS009		36,92 €	36,92 €	1	12

Manometro per Autoclave



Laterale Radiale

Codice	Riferimenti	Listino A	Listino B	Conf.	Box
MABR010	Lat.. D. 1/4"	5,11 €	5,67 €	1	12
MAB010	RaD. D.1/4"	4,55 €	5,06 €	1	12



Centralina Prelievo Acqua per pompe autodescanti riarmo automatico

Codice	Riferimenti	Listino A	Listino B	Conf.	Box
CCAA	HP. 1	130,64 €	130,64 €	1	6
CCAAS	HP. 1,5	197,51 €	197,51 €	1	4

Contatore Asciutto Getto Unico Completo Coperchio & Raccordi



PROMO



Codice	Riferimenti	Listino A	Listino B	Conf.	Box
CAUD	D. 1/2"	30,39 €	33,73 €	1	20
CAUG	D. 3/4"	32,66 €	36,25 €	1	20
CAUH	D. 1"	43,34 €	48,11 €	1	10



Pressostato Calpeda 1,4 - 2,8 Bar

Codice	Riferimenti	Listino A	Listino B	Conf.	Box
PMAT5M	PMAT5M	12,39 €	13,75 €	1	10
PMAT5M10	PMAT5M10	11,77 €	13,06 €	10	10



Condensatori Con Cavo O Faston

Codice	Riferimenti	Listino A	Listino B	Conf.	Box
C10MF	c/faston	2,28 €	2,53 €	1	10
C12,5MF	c/faston	4,40 €	4,89 €	1	10
C16MF	c/faston	4,61 €	5,11 €	1	10
C20MF	c/faston	5,09 €	5,65 €	1	10
C25MF	c/faston	6,44 €	7,15 €	1	10
C30MF	c/faston	6,76 €	7,50 €	1	10
C40MF	c/faston	7,84 €	8,71 €	1	10
C50MF	c/faston	10,68 €	11,85 €	1	10
CDICB12,5	c/faston	4,40 €	4,89 €	1	10
CDICB16	c/faston	4,61 €	5,11 €	1	10
CDICB20	c/faston	5,09 €	5,65 €	1	10



Raccordo 5 Vie 1" per autoclave

Codice	Riferimenti	Listino A	Listino B	Conf.	Box
R1A90M	D. 1" cm. 9	4,78 €	5,31 €	1	10
R1A110	D. 1" cm. 11	5,37 €	5,96 €	1	10



Indicatore 7 Livello Inc. 503

Codice	Riferimenti	Listino A	Listino B	Conf.	Box
ILL503		47,29 €	52,49 €	1	6

Contatore Getto Multiplo Completo Coperchio & Raccordi Ideale per portate acque maggiori



Codice	Riferimenti	Listino A	Listino B	Conf.	Box
CAMD	D. 1/2"	33,22 €	36,88 €	1	20
CAMG	D. 3/4"	39,85 €	44,23 €	1	20
CAMH	D. 1"	60,12 €	66,73 €	1	10
CAMHB	D. 1 1/4"	83,62 €	92,82 €	1	4



Sfera Staffa & Base Da 24 Lt

Codice	Riferimenti	Listino A	Listino B	Off.	Box
SS24C		65,68 €	72,91 €	1	25
SS24C5	Offertax5	63,26 €	70,22 €	5	25



I serbatoi sanitari polifunzionali a di espansione per impianti di H2O membrana fissa hanno il pregio di poter essere impiegati sia come vasi calda sanitaria o per impianti di riscaldamento, idonei ad assorbire le variazioni di volume causate dall'aumento di temperatura, sia come autoclavi negli impianti sanitari per acqua fredda. Questo duplice impiego è reso



Codice	Cap.	Diam.	H	DN1	N	DN1	Listino A	Listino B
	litri	mm	mm	mm				
A2C2L11	5	205	225	3/4"			43,01 €	47,74 €
A2C2L16	8	205	300	3/4"			34,94 €	38,79 €
A2C2L19	11	270	300	3/4"			43,54 €	48,33 €
A2C2L24	18	270	410	3/4"			49,47 €	54,91 €
A2C2L27	24	320	355	1"			56,98 €	63,25 €
A2C2L31	35	400	390	1"			89,25 €	99,07 €
A2C2L34	50	400	585	1"			123,68 €	137,28 €
A2C2L37	80	400	820	1"			189,26 €	210,08 €
A2C2L38	100	500	775	1 1/4"			268,83 €	298,40 €



Polmone Autoclave Collaudato 8 bar



Codice	Riferimenti	Listino A	Listino B	Off.	Box
PO100	106 40 Lt. 100	331,41 €	367,87 €		
PO200	138 45 Lt. 200	432,57 €	480,15 €		
PO300	149 55 Lt. 300	480,97 €	533,88 €		
PO500	175 65 Lt. 500	676,33 €	750,73 €		
PO750	200 75 Lt. 750	963,87 €	1069,90 €		
PO1000	205 85 Lt. 1000	1302,05 €	1445,27 €		



COLLETORE INOX ACCOPIAMENTO POMPE



Codice	Riferimenti	Listino A	Listino B	Off.	Box
110155	D. 1"-L200	56,93 €	63,19 €	1	10
110156	D. 1 1/4"-L220	65,79 €	73,02 €	1	10
110157	D. 1 1/2"-L240	79,70 €	88,47 €	1	10
110158	D. 2"-L260	99,94 €	110,94 €	1	10



Sfera Hydrosat Norme Ce Lt.24



Codice	Riferimenti	Listino A	Listino B	Off.	Box
S24C		32,22 €	35,77 €	1	24
S24C24	Offertax24	30,61 €	33,98 €	24	24

Sfera per autoclave a membrana



Codice	Riferimenti	Listino A	Listino B	Off.	Box
S2C	2 LT	33,98 €	37,72 €	1	50
S5C	5 LT	36,46 €	40,47 €	1	40
S8C	8 LT	41,39 €	45,95 €	1	30
S12C	12 LT	47,31 €	52,52 €	1	24
S18C	18 LT	53,13 €	58,98 €	1	24



Polmone Autoclave N/collaudato

Codice	Riferimenti	Listino A	Listino B	Off.	Box
PZ100B	78 50 Lt. 50	269,08 €	269,08 €		



Polmone Autoclave N/collaudato



Codice	Riferimenti	Listino A	Listino B	Off.	Box
PZ50	88 40 Lt. 50	233,54 €	233,54 €		
PZ100	106 40 Lt. 100	220,75 €	220,75 €		
PZ200	138 45 Lt. 200	348,56 €	348,56 €		
PZ300	149 55 Lt. 300	418,28 €	418,28 €		
PZ500	175 65 Lt. 500	1301,24 €	1301,24 €		
PZ750	200 75 Lt. 750	1626,55 €	1626,55 €		
PZ1000	205 85 Lt. 1000	1905,39 €	1905,39 €		



Membrana Epdm Lt. 25 B/Larga Zz Per Sfere Zilmel - Varem Zz

Codice	Riferimenti	Listino A	Listino B	Off.	Box
MIA25LE	Membrana 24	4,05 €	4,29 €	1	25



Pompa Calpeda Ngxm



Codice	Riferimenti	Listino A	Listino B	Off.	Box
NGXM2	HP. 0,60	215,68 €	239,41 €	1	1
NGXM3	HP. 0,75	241,75 €	268,34 €	1	1
NGXM4	HP. 1,00	231,22 €	256,66 €	1	1

Elettropompa centrifughe Serie NMD Calpeda



Codice	Riferimenti	Listino A	Listino B	Off.	Box
NMDM20110A	HP. 1,00	348,41 €	386,73 €	1	1
NMDM20140B	HP. 1,50	540,39 €	599,83 €	1	1
NMDM20140AE	HP. 2,00	637,02 €	707,09 €	1	1
NMD25190CB	HP. 3,00	1029,72 €	1142,99 €	1	1
NMD25190BA	HP. 4,00	1144,14 €	1269,99 €	1	1
NMD25190AB	HP. 5,5	1398,96 €	1552,85 €	1	1

Pompa Calpeda Ctm 61



Codice	Riferimenti	Listino A	Listino B	Off.	Box
CTM61		141,27 €	156,81 €	1	1

Elettropompe Multistadio funzionamento silenzioso



Codice	Riferimenti	Listino A	Listino B	Off.	Box
MGPM203	HP. 0,60	229,31 €	254,53 €	1	1
MGPM204	HP. 0,75	260,81 €	289,50 €	1	1
MGPM205	HP. 1,00	304,54 €	338,04 €	1	1

Sistema di pressurizzazione autoadescante a velocità variabile.

META è una soluzione plug and play, la pompa è dotata di sensore di pressione, valvola di non ritorno e un serbatoio a membrana integrati. L'elettronica comanda in modo automatico l'avviamento lo spegnimento e consente di mantenere la pressione costante.



Codice	Riferimenti	Listino A	Listino B	Off.	Box
META		912,49 €	1012,87 €	1	1

Sistema di pressurizzazione autoadescante a velocità variabile.

META è una soluzione plug and play, la pompa è dotata di sensore di pressione, valvola di non ritorno e un serbatoio a membrana integrati. L'elettronica comanda in modo automatico l'avviamento lo spegnimento e consente di mantenere la pressione costante.



Codice	Riferimenti	Listino A	Listino B	Off.	Box
METASMALL		770,29 €	855,02 €	1	1



Elettropompa autodescante Serie NGL Calpeda



Codice	Riferimenti	Listino A	Listino B	Off.	Box
NGLM2	HP. 0,75	199,07 €	220,96 €	1	1
NGLM3	HP. 0,90	214,61 €	238,22 €	1	1
NGLM4	HP. 1,00	230,18 €	255,50 €	1	1

Elettropompa Serie CAM Autodescante Calpeda



Codice	Riferimenti	Listino A	Listino B	Off.	Box
CAM80E	Hp. 0,6	258,14 €	286,53 €	1	1
CAM90A	Hp. 0,75	327,08 €	363,05 €	1	1
CAM91A	Hp. 1,00	336,56 €	373,58 €	1	1

Elettropompa autodescante corpo inox Serie MXPM



Codice	Riferimenti	Listino A	Listino B	Off.	Box
MXPM203	HP. 0,60	237,38 €	263,49 €	1	1
MXPM204	HP. 0,75	267,60 €	297,04 €	1	1
MXPM205	HP. 1,00	335,52 €	372,43 €	1	1
MXPM404	HP. 1,00	348,04 €	386,33 €	1	1
MXPM405	HP. 1,5	416,66 €	462,49 €	1	1

Pompa Sommersibile In Acciaio Inox



Codice	Riferimenti	Listino A	Listino B	Off.	Box
GXRM9	Hp. 0,33	300,06 €	333,07 €	1	1
GXRM11	Hp. 0,5	324,46 €	360,15 €	1	1
GXRM13	Hp. 0,6	388,17 €	430,86 €	1	1

Elettropompa Calpeda Sommersibile GQSM 40-9 V.230/50



Codice	Riferimenti	Listino A	Listino B	Off.	Box
GQSM230		399,58 €	443,54 €	1	1

Pompe centrifughe multistadio sommergibili con camicia in acciaio inossidabile, bocca di mandata verticale e valvola di non ritorno in aspirazione. Capacità di aspirare acqua fino a 1 millimetro dal Suolo



Codice	Riferimenti	Listino A	Listino B	Off.	Box
GXMZERO		278,09 €	308,68 €	1	1



Elettropompa Autoadescante



Codice	Riferimenti	Listino A	Listino B	Off.	Box
SP5	Hp. 0,75	341,58 €	379,15 €	1	1
SP7	Hp. 1	398,50 €	442,34 €	1	1



Elettropompe Centrifughe Con Bocche Filetate In Acciaio Inox



Codice	Riferimenti	Listino A	Listino B	Off.	Box
CAM70/45	Hp. 1,2	478,33 €	530,95 €	1	1
CAM70/33	Hp. 1	576,88 €	640,34 €	1	1



Elettropompe Periferica 0,3 Kw 0,4 Hp



Codice	Riferimenti	Listino A	Listino B	Off.	Box
PM16	Hp. 0,4	76,79 €	85,24 €	1	1



Elettropompe Centrifuga Autoadescante 0,55 Kw 0,75Hp



Codice	Riferimenti	Listino A	Listino B	Off.	Box
BGM5	Hp. 0,75	290,97 €	322,98 €	1	1



Elettropompe Centrifuga Autoadescante 0,75 Kw 1Hp



Codice	Riferimenti	Listino A	Listino B	Off.	Box
BGM7	Hp. 1,00	303,62 €	337,02 €	1	1
KBGM5	Hp. 0,75	587,88 €	652,55 €	3	3
KBGM7	Hp. 1,00	622,74 €	691,24 €	3	3



Elettropompe Multistadio E Multigrante 0,5 Kw 0,75 Hp



Codice	Riferimenti	Listino A	Listino B	Off.	Box
3HM04P05M	Hp. 0,5	253,86 €	281,78 €	1	1
3HM03P05M	Hp. 0,75	261,41 €	290,16 €	1	1
3HM05P07M	Hp. 1	345,06 €	383,02 €	1	1



Elettropompa Drenaggio Acque Sporche E Chiare



Codice	Riferimenti	Listino A	Listino B	Off.	Box
DOC3	Hp. 0,33	194,84 €	216,27 €	1	1
DOC7	Hp. 0,75	254,00 €	281,94 €	1	1



Elettropompa Sommersa 5" Con Galleggiante 0,55



Codice	Riferimenti	Listino A	Listino B	Off.	Box
3SC4/05/5CG	Hp. 1	535,37 €	594,26 €	1	1



Elettropompa Sommersa 5" Con Galleggiante 0,55



Codice	Riferimenti	Listino A	Listino B	Off.	Box
DOMO7VX	Hp. 0,33	308,23 €	342,13 €	1	1
DOMO10VX	Hp. 0,75	382,97 €	425,10 €	1	1

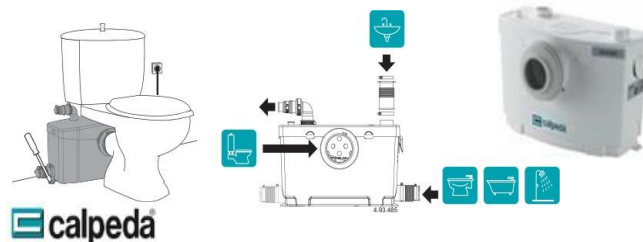

Codice	Riferimenti	Listino A	Listino B	Off.	Box
GEOCOMP		815,38 €	905,07 €	1	1

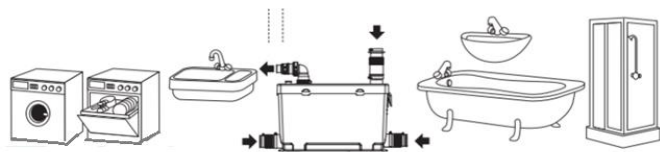

SOLO ATTACCHI SANITARI NO WC

Codice	Riferimenti	Listino A	Listino B	Off.	Box
GEOCLEAN		782,84 €	868,95 €	1	1

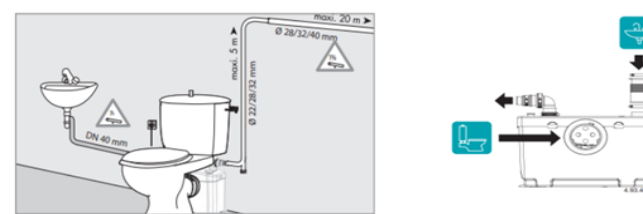

VASO+ATTACCO LAVABO

Codice	Riferimenti	Listino A	Listino B	Off.	Box
GEOTRIT		741,68 €	823,26 €	1	1



Mix Jose' Bidet Cromo



Codice	Riferimenti	Listino A	Listino B	Off.	Box
MBJE00		52,37 €	52,37 €	1	5
MBJE00x5	Offertax5	49,61 €	49,61 €	5	5
MBJE00x10	Offertax10	47,13 €	47,13 €	10	5
MBJE00x15	Offertax15	44,65 €	44,65 €	15	5



Mix Jose' Lavabo Cromo



Codice	Riferimenti	Listino A	Listino B	Off.	Box
MLJE00		52,37 €	52,37 €	1	5
MLJE00x5	Offertax5	49,61 €	49,61 €	5	5
MLJE00x10	Offertax10	47,13 €	47,13 €	10	5
MLJE00x15	Offertax15	44,65 €	44,65 €	15	5



Mix Bidet Jose' Bronzo



Codice	Riferimenti	Listino A	Listino B	Off.	Box
MBJE47		64,34 €	64,34 €	1	5
MBJE47x5	Offertax5	60,95 €	60,95 €	5	5
MBJE47x10	Offertax10	57,90 €	57,90 €	10	5
MBJE47x15	Offertax15	54,86 €	54,86 €	15	5



Mix Lavabo Jose' Bronzo



Codice	Riferimenti	Listino A	Listino B	Off.	Box
MLJE47		64,34 €	64,34 €	1	5
MLJE47x5	Offertax5	60,95 €	60,95 €	5	5
MLJE47x10	Offertax10	57,90 €	57,90 €	10	5
MLJE47x15	Offertax15	54,86 €	54,86 €	15	5



Mix Doccia Incasso Bronzo Jose



Codice	Riferimenti	Listino A	Listino B	Off.	Box
MDIJE47		47,88 €	47,88 €	1	5
MDIJE47x5	Offertax5	45,36 €	45,36 €	5	5
MDIJE47x10	Offertax10	43,09 €	43,09 €	10	5
MDIJE47x15	Offertax15	40,82 €	40,82 €	15	5



Mix Vasca Jose' Bronzo



Codice	Riferimenti	Listino A	Listino B	Off.	Box
MVJE47		83,79 €	83,79 €	1	5
MVJE47x5	Offertax5	79,38 €	79,38 €	5	5
MVJE47x10	Offertax10	75,41 €	75,41 €	10	5
MVJE47x15	Offertax15	71,44 €	71,44 €	15	5



Mix Doccia Esterno Jose' Bronzo



Codice	Riferimenti	Listino A	Listino B	Off.	Box
MDEJ47		83,79 €	83,79 €	1	5
MDEJ47x5	Offertax5	79,38 €	79,38 €	5	5
MDEJ47x10	Offertax10	75,41 €	75,41 €	10	5
MDEJ47x15	Offertax15	71,44 €	71,44 €	15	5



Mlx Lavello Monof. C/Bassa Jose' Bronzo



Codice	Riferimenti	Listino A	Listino B	Off.	Box
MLMJ47		58,17 €	58,17 €	1	5
MLMJ47x5	Offertax5	55,11 €	55,11 €	5	5
MLMJ47x10	Offertax10	52,36 €	52,36 €	10	5
MLMJ47x15	Offertax15	49,60 €	49,60 €	15	5



Mix Lavabo Kristal C/Scarico

ZIPPONI
L'ACQUALITÀ È LO STILE



Codice	Riferimenti	Listino A	Listino B	Off.	Box
KR303CR11KZ		49,08 €	49,08 €	1	5
KR303CR11KZx5	Offertax5	46,49 €	46,49 €	5	5
KR303CR11KZx10	Offertax10	44,17 €	44,17 €	10	5
KR303CR11KZx15	Offertax15	41,84 €	41,84 €	15	5



Mix Bidet Kristal C/Scarico

ZIPPONI
L'ACQUALITÀ È LO STILE



Codice	Riferimenti	Listino A	Listino B	Off.	Box
KR403CR11KZ		49,08 €	49,08 €	1	5
KR403CR11KZx5	Offertax5	46,49 €	46,49 €	5	5
KR403CR11KZx10	Offertax10	44,17 €	44,17 €	10	5
KR403CR11KZx15	Offertax15	41,84 €	41,84 €	15	5



Mix Incasso Doccia
Kristal



Codice	Riferimenti	Listino A	Listino B	Off.	Box
KR002CR00KZ		38,60 €	38,60 €	1	5
KR002CR00KZx5	Offertax5	36,57 €	36,57 €	5	5
KR002CR00KZx10	Offertax10	34,74 €	34,74 €	10	5
KR002CR00KZx15	Offertax15	32,91 €	32,91 €	15	5



Mix Vasca Kristal



Codice	Riferimenti	Listino A	Listino B	Off.	Box
KR103CR54KZ		82,29 €	82,29 €	1	5
KR103CR54KZx5	Offertax5	77,96 €	77,96 €	5	5
KR103CR54KZx10	Offertax10	74,06 €	74,06 €	10	5
KR103CR54KZx15	Offertax15	70,17 €	70,17 €	15	5



Mix Lavabo Con Scar. 1"
Cartuccia D. 40



Codice	Riferimenti	Listino A	Listino B	Off.	Box
MLDE00		43,06 €	43,06 €	1	5
MLDE00x5	Offertax5	40,80 €	40,80 €	5	5
MLDE00x10	Offertax10	38,76 €	38,76 €	10	5
MLDE00x15	Offertax15	36,72 €	36,72 €	15	5



Mix Debora Bidet Con Scar.
1"



Codice	Riferimenti	Listino A	Listino B	Off.	Box
MBDE00		43,06 €	43,06 €	1	5
MBDE00x5	Offertax5	40,80 €	40,80 €	5	5
MBDE00x10	Offertax10	38,76 €	38,76 €	10	5
MBDE00x15	Offertax15	36,72 €	36,72 €	15	5



Mix Debora Doccia
Incasso C.40



Codice	Riferimenti	Listino A	Listino B	Off.	Box
MDIDE00		30,25 €	30,25 €	1	5
MDIDE00x5	Offertax5	28,66 €	28,66 €	5	5
MDIDE00x10	Offertax10	27,23 €	27,23 €	10	5
MDIDE00x15	Offertax15	25,80 €	25,80 €	15	5



Mix Vasca Debora Ec. C
/Dupl.



Codice	Riferimenti	Listino A	Listino B	Off.	Box
MVDE00		56,50 €	56,50 €	1	5
MVDE00x5	Offertax5	53,52 €	53,52 €	5	5
MVDE00x10	Offertax10	50,85 €	50,85 €	10	5
MVDE00x15	Offertax15	48,17 €	48,17 €	15	5



Mix Doccia Esteno Debora



Codice	Riferimenti	Listino A	Listino B	Off.	Box
MDEDE00	Cromo	35,01 €	35,01 €	1	5
MDEDE00					



Miscelatore Vasca Completo Di
Doccia Flex E Supporto Serie Nx



Codice	Riferimenti	Listino A	Listino B	Off.	Box
MXVAMCNXCCR	Cromo	86,18 €	86,18 €	1	5
MXVAMCNXCCR					



Miscelatore Bidet Serie Nx



Codice	Riferimenti	Listino A	Listino B	Off.	Box
MXBIMCNXCCR	Cromo	72,61 €	72,61 €	1	5
MXBIMCNXCCR					



Miscelatore Lavabo Serie



Codice	Riferimenti	Listino A	Listino B	Off.	Box
MXLAMCNXCCR	Cromo	72,61 €	72,61 €	1	5
MXLAMCNXCCR					



Miscelatore Doccia
Incasso Con Deviatore Serie
Nx Piastra Quadra



Codice	Riferimenti	Listino A	Listino B	Off.	Box
MXDDMCNXQCR	Cromo	84,73 €	84,73 €	1	5
MXDDMCNXQCR					



Fonte Bidet 3/8 C/Scar Cr
Maia



SERIE MAIA

Codice	Riferimenti	Listino A	Listino B	Off.	Box
FO410CR-001	Cromo	86,79 €	86,79 €	1	5



Fonte Lavabo 3/8 C/Scar Cr
Maia



SERIE MAIA

Codice	Riferimenti	Listino A	Listino B	Off.	Box
FO310CR-001	Cromo	86,79 €	86,79 €	1	5



Mix Bidet Helios2 C/Scarico



Codice	Riferimenti	Listino A	Listino B	Off.	Box
HN403CR11NZ	Cromo	47,09 €	47,09 €	1	5
HN403CR11NZ					



Mix Doccia Incasso Helios
2



Codice	Riferimenti	Listino A	Listino B	Off.	Box
HN001CR00NZ	Cromo	37,18 €	37,18 €	1	5
HN001CR00NZ					



Mix Incasso Doccia
Maia



SERIE MAIA

Codice	Riferimenti	Listino A	Listino B	Off.	Box
FO001CR00FZ	Cromo	53,89 €	53,89 €	1	5
FO001CR00FZ					



Fonte Lavabo Alto 3/8 C/Scar
Crmaia



SERIE MAIA

Codice	Riferimenti	Listino A	Listino B	Off.	Box
FO350CR-001	Cromo	140,36 €	140,36 €	1	5



Fonte Lavabo Incasso C/Scar
Cr



SERIE MAIA

Codice	Riferimenti	Listino A	Listino B	Off.	Box
FO301CR-001	Cromo	189,76 €	189,76 €	1	5



Mix Lavabo Helios2 C/Scarico



Codice	Riferimenti	Listino A	Listino B	Off.	Box
HN303CR11NZ	Cromo	47,09 €	47,09 €	1	5
HN303CR11NZ					



Mix Doccia Incasso
Cromo Profilo



Codice	Riferimenti	Listino A	Listino B	Off.	Box
PR009CR00QZ	Cromo	38,12 €	38,12 €	1	5
PR009CR00QZ					



Monocomando Lavabo Con Scarico Automatico Mix 18 Ascot

ASCOT

Codice	Riferimenti	Listino A	Listino B	Off.	Box
MIX018/A		43,38 €	43,38 €	1	5
MIX018/Ax5	Offertax5	40,48 €	40,48 €	5	5
MIX018/Ax10	Offertax10	38,56 €	38,56 €	10	5
MIX018/Ax15	Offertax15	35,66 €	35,66 €	15	5



Monocomando Bidet Con Scarico Automatico Mix 16 Ascot

ASCOT

Codice	Riferimenti	Listino A	Listino B	Off.	Box
MIX016/A		43,38 €	43,38 €	1	5
MIX016/Ax5	Offertax5	40,48 €	40,48 €	5	5
MIX016/Ax10	Offertax10	38,56 €	38,56 €	10	5
MIX016/Ax15	Offertax15	35,66 €	35,66 €	15	5



Gruppo Vasca Esterno Con Flessibile E Doccetta Mix 10 Bob

ASCOT

Codice	Riferimenti	Listino A	Listino B	Off.	Box
MIX010/B		98,23 €	98,23 €	1	5
MIX010/Bx5	Offertax5	91,68 €	91,68 €	5	5
MIX010/Bx10	Offertax10	87,32 €	87,32 €	10	5
MIX010/Bx15	Offertax15	80,77 €	80,77 €	15	5



Miscelatore Doccia Incasso Mix 14 Ascot

ASCOT

Codice	Riferimenti	Listino A	Listino B	Off.	Box
MIX014/A		35,72 €	35,72 €	1	5
MIX014/Ax5	Offertax5	33,34 €	33,34 €	5	5
MIX014/Ax10	Offertax10	31,75 €	31,75 €	10	5
MIX014/Ax15	Offertax15	29,37 €	29,37 €	15	5



Miscelatore Doccia 1/2" Pollice Mix 23 Ascot

ASCOT

Codice	Riferimenti	Listino A	Listino B	Off.	Box
MIX023/A		38,27 €	38,27 €	1	5
MIX023/Ax5	Offertax5	35,72 €	35,72 €	5	5
MIX023/Ax10	Offertax10	34,02 €	34,02 €	10	5
MIX023/Ax15	Offertax15	31,47 €	31,47 €	15	5



Monocomando Lavello Con Canna Fusa Mix 21 Ascot

ASCOT

Codice	Riferimenti	Listino A	Listino B	Off.	Box
MIX021/A		43,38 €	43,38 €	1	5
MIX021/Ax5	Offertax5	40,48 €	40,48 €	5	5
MIX021/Ax10	Offertax10	38,56 €	38,56 €	10	5
MIX021/Ax15	Offertax15	35,66 €	35,66 €	15	5



Gruppo Lavello Parete Con Canna Girevole Mix 22 Ascot

ASCOT

Codice	Riferimenti	Listino A	Listino B	Off.	Box
MIX022/A		48,48 €	48,48 €	1	5
MIX022/Ax5	Offertax5	45,25 €	45,25 €	5	5
MIX022/Ax10	Offertax10	43,09 €	43,09 €	10	5
MIX022/Ax15	Offertax15	39,86 €	39,86 €	15	5



Miscelatore Lavello Professionale Chef Mixer

ARVEN
CHEF MIXER

Codice	Riferimenti	Listino A	Listino B	Off.	Box
MIXCHEF		196,47 €	196,47 €	1	5
MIXCHEFx5	Offertax5	183,37 €	183,37 €	5	5
MIXCHEFx10	Offertax10	174,64 €	174,64 €	10	5
MIXCHEFx15	Offertax15	161,54 €	161,54 €	15	5



Gruppo Lavello Parete Con Canna Girevole Mix 22 Maxima

ASCOT

Codice	Riferimenti	Listino A	Listino B	Off.	Box
MIX022/M		56,13 €	56,13 €	1	5
MIX022/Mx5	Offertax5	52,39 €	52,39 €	5	5
MIX022/Mx10	Offertax10	49,90 €	49,90 €	10	5
MIX022/Mx15	Offertax15	46,15 €	46,15 €	15	5



Gruppo Lavello Parete Con Canna Girevolea Mix 22 Bob

ASCOT

Codice	Riferimenti	Listino A	Listino B	Off.	Box
MIX022/B		63,79 €	63,79 €	1	5
MIX022/Bx5	Offertax5	59,54 €	59,54 €	5	5
MIX022/Bx10	Offertax10	56,70 €	56,70 €	10	5
MIX022/Bx15	Offertax15	52,45 €	52,45 €	15	5



Monocomando Lavello Con
Canna Fusa Mix 21 Bob

Codice	Riferimenti	Listino A	Listino B	Off.	Box
MIX021/B		66,34 €	66,34 €	1	5
MIX021/Bx5	Offertax5	61,92 €	61,92 €	5	5
MIX021/Bx10	Offertax10	58,97 €	58,97 €	10	5
MIX021/Bx15	Offertax15	54,55 €	54,55 €	15	5



Monocomando Lavello Con
Canna Fusa Mix 21 Maxima

Codice	Riferimenti	Listino A	Listino B	Off.	Box
MIX021/M		47,20 €	47,20 €	1	5
MIX021/Mx5	Offertax5	44,06 €	44,06 €	5	5
MIX021/Mx10	Offertax10	41,96 €	41,96 €	10	5
MIX021/Mx15	Offertax15	38,81 €	38,81 €	15	5



Monocomando Bidet Con
Scarico Automatico Mix 16
Maxima

ARVEN
MAXIMA-B

Codice	Riferimenti	Listino A	Listino B	Off.	Box
MIX016/M		57,41 €	57,41 €	1	5
MIX016/Mx5	Offertax5	53,58 €	53,58 €	5	5
MIX016/Mx10	Offertax10	51,03 €	51,03 €	10	5
MIX016/Mx15	Offertax15	47,20 €	47,20 €	15	5



Monocomando Bidet Con
Scarico Automatico Mix 16
Bob

Codice	Riferimenti	Listino A	Listino B	Off.	Box
MIX016/B		58,68 €	58,68 €	1	5
MIX016/Bx5	Offertax5	54,77 €	54,77 €	5	5
MIX016/Bx10	Offertax10	52,16 €	52,16 €	10	5
MIX016/Bx15	Offertax15	48,25 €	48,25 €	15	5



Monocomando Lavabo Con
Scarico Automatico Mix 18
Maxima

ARVEN
MAXIMA-B

Codice	Riferimenti	Listino A	Listino B	Off.	Box
MIX018/M		57,41 €	57,41 €	1	5
MIX018/Mx5	Offertax5	53,58 €	53,58 €	5	5
MIX018/Mx10	Offertax10	51,03 €	51,03 €	10	5
MIX018/Mx15	Offertax15	47,20 €	47,20 €	15	5



Monocomando Lavabo Con
Scarico Automatico Mix 18
Bob

Codice	Riferimenti	Listino A	Listino B	Off.	Box
MIX018/B		63,79 €	63,79 €	1	5
MIX018/Bx5	Offertax5	59,54 €	59,54 €	5	5
MIX018/Bx10	Offertax10	56,70 €	56,70 €	10	5
MIX018/Bx15	Offertax15	52,45 €	52,45 €	15	5



Gruppo Vasca Esterno Con
Flessibile E Doccetta Mix 10
Maxima

ARVEN
MAXIMA-B

Codice	Riferimenti	Listino A	Listino B	Off.	Box
MIX010/M		71,44 €	71,44 €	1	5
MIX010/Mx5	Offertax5	66,68 €	66,68 €	5	5
MIX010/Mx10	Offertax10	63,50 €	63,50 €	10	5
MIX010/Mx15	Offertax15	58,74 €	58,74 €	15	5



Gruppo Vasca Esterno Con
Flessibile E Doccetta Mix 10
Bob

Codice	Riferimenti	Listino A	Listino B	Off.	Box
MIX010/B		98,23 €	98,23 €	1	5
MIX010/Bx5	Offertax5	91,68 €	91,68 €	5	5
MIX010/Bx10	Offertax10	87,32 €	87,32 €	10	5
MIX010/Bx15	Offertax15	80,77 €	80,77 €	15	5



Miscelatore Doccia Incasso
Bob

Codice	Riferimenti	Listino A	Listino B	Off.	Box
MIX014/B		49,75 €	49,75 €	1	5
MIX014/Bx5	Offertax5	46,44 €	46,44 €	5	5
MIX014/Bx10	Offertax10	44,23 €	44,23 €	10	5
MIX014/Bx15	Offertax15	40,91 €	40,91 €	15	5



Miscelatore Doccia Incasso
Bob 14 A Con Deviatore

Codice	Riferimenti	Listino A	Listino B	Off.	Box
MIX014A/B		88,03 €	88,03 €	1	5
MIX014A/Bx5	Offertax5	82,16 €	82,16 €	5	5
MIX014A/Bx10	Offertax10	78,25 €	78,25 €	10	5
MIX014A/Bx15	Offertax15	72,38 €	72,38 €	15	5



Bauedge Set Misce.
Monocomando Vasca Inc.
Doccia Grohe



Codice	Riferimenti	Listino A	Listino B	Off.	Box
29079000		131,43 €	131,43 €	1	5



Bauedge Miscelatore
Monocomando Bidet Grohe



Codice	Riferimenti	Listino A	Listino B	Off.	Box
23331000		68,06 €	68,06 €	1	5



Bauedge
Miscelatore Monocomando
Lavabo Taglia M Grohe



Codice	Riferimenti	Listino A	Listino B	Off.	Box
23758000		82,14 €	82,14 €	1	5



Bauedge Miscelatore
Monocomando Bidet Grohe



Codice	Riferimenti	Listino A	Listino B	Off.	Box
23331000		68,06 €	68,06 €	1	5



Lavello Cucina Bg De 2F
Hide Cromo

Codice	Riferimenti	Listino A	Listino B	Off.	Box
KI510CR00KZ		255,43 €	255,43 €	1	5
KI510CR00KZx5	Offertax5	238,40 €	238,40 €	5	5
KI510CR00KZx10	Offertax10	227,05 €	227,05 €	10	5
KI510CR00KZx15	Offertax15	210,02 €	210,02 €	15	5



Mix Bidet Alessia Cart. Da 35



Codice	Riferimenti	Listino A	Listino B	Off.	Box
MBA00		17,51 €	17,51 €	1	5
MBA00x5	Offertax5	16,58 €	16,58 €	5	5
MBA00x10	Offertax10	15,76 €	15,76 €	10	5
MBA00x15	Offertax15	14,93 €	14,93 €	15	5



Mix Lavello Parete Debora
Terra Di Francia

FINITURA DISPONIBILE:
TERRA DI FRANCIA

TerraFrancia



ARMANDO
VICARIO

Codice	Riferimenti	Listino A	Listino B	Off.	Box
MLPDE100		125,57 €	125,57 €	1	5
MLPDE100x5	Offertax5	117,20 €	117,20 €	5	5
MLPDE100x10	Offertax10	111,62 €	111,62 €	10	5
MLPDE100x15	Offertax15	103,25 €	103,25 €	15	5



Miscelatore Monocomando
Per Lavello Cucina Con
Canna Ponte. Mix/62

ARMANDO
VICARIO

Codice	Riferimenti	Listino A	Listino B	Off.	Box
MIX6200		107,16 €	107,16 €	1	5
MIX6200x5	Offertax5	100,02 €	100,02 €	5	5
MIX6200x10	Offertax10	95,26 €	95,26 €	10	5
MIX6200x15	Offertax15	88,11 €	88,11 €	15	5



Mix Lavello Botticella
Cocca Conica Standard

WTS GROUP
ZIPPONI

Codice	Riferimenti	Listino A	Listino B	Off.	Box
AA630CR10LZ		91,00 €	91,00 €	1	5
AA630CR10LZx5	Offertax5	84,94 €	84,94 €	5	5
AA630CR10LZx10	Offertax10	80,89 €	80,89 €	10	5
AA630CR10LZx15	Offertax15	74,83 €	74,83 €	15	5



Mix Cucina Leva
Laterale Can. L.F.3/8

WTS GROUP
ZIPPONI

Codice	Riferimenti	Listino A	Listino B	Off.	Box
CU643CR10LZ		90,72 €	90,72 €	1	5
CU643CR10LZx5	Offertax5	84,67 €	84,67 €	5	5
CU643CR10LZx10	Offertax10	80,64 €	80,64 €	10	5
CU643CR10LZx15	Offertax15	74,59 €	74,59 €	15	5



Mix Lavello Monoforo
"Debora" Canna Alta Fusa
Pesante

Hydro.Sat®

Codice	Riferimenti	Listino A	Listino B	Off.	Box
MLMLLDE00		110,22 €	110,22 €	1	5
MLMLLDE00x5	Offertax5	102,88 €	102,88 €	5	5
MLMLLDE00x10	Offertax10	97,98 €	97,98 €	10	5
MLMLLDE00x15	Offertax15	90,63 €	90,63 €	15	5



Mix Lavello Monoforo
"Debora" Canna Alta Tubo
Ombrello

Hydro.Sat®

Codice	Riferimenti	Listino A	Listino B	Off.	Box
MLMLPDE00		73,48 €	73,48 €	1	5
MLMLPDE00x5	Offertax5	68,58 €	68,58 €	5	5
MLMLPDE00x10	Offertax10	65,32 €	65,32 €	10	5
MLMLPDE00x15	Offertax15	60,42 €	60,42 €	15	5



Miscelatore Lavello Monoforo
canna alta Mod. Jolla Mix/30
Onda Cromato

ARMANDO
VICARIO

Codice	Riferimenti	Listino A	Listino B	Off.	Box
JOLLA00		79,73 €	79,73 €	1	5
JOLLA00x5	Offertax5	74,41 €	74,41 €	5	5
JOLLA00x10	Offertax10	70,87 €	70,87 €	10	5
JOLLA00x15	Offertax15	65,56 €	65,56 €	15	5



Mix Lav. Mon.Rodeo Mix/3
Cromo

ARMANDO
VICARIO

Codice	Riferimenti	Listino A	Listino B	Off.	Box
RODEO00		107,16 €	107,16 €	1	5
RODEO00x5	Offertax5	100,02 €	100,02 €	5	5
RODEO00x10	Offertax10	95,26 €	95,26 €	10	5
RODEO00x15	Offertax15	88,11 €	88,11 €	15	5



Miscelatore Cucina Con
Canna Alta cartuccia 40
colore Avena



Codice	Riferimenti	Listino A	Listino B	Off.	Box
52943		41,62 €	41,62 €	1	5



Miscelatore lavello Monoforo
Canna Alta Avena



Codice	Riferimenti	Listino A	Listino B	Off.	Box
69146		48,33 €	48,33 €	1	5



Miscelatore Cucina Con
Canna Snodabile Colore
Cromo Canna Nera



Codice	Riferimenti	Listino A	Listino B	Off.	Box
69410		44,30 €	44,30 €	1	5



Miscelatore lavello Monoforo
Canna Alta Cromo



Codice	Riferimenti	Listino A	Listino B	Off.	Box
69145		49,67 €	49,67 €	1	5



Miscelatore Cucina Con
Doccetta Estraibile Cromato



Codice	Riferimenti	Listino A	Listino B	Off.	Box
79569		75,18 €	75,18 €	1	5



Miscelatore lavello Monoforo
Canna Alta Bianco



Codice	Riferimenti	Listino A	Listino B	Off.	Box
79830		51,02 €	51,02 €	1	5



Leva Debora Mod. Europa
Cromo

Codice	Riferimenti	Listino A	Listino B	Off.	Box
LDE00		9,53 €	9,53 €	1	5
LDE00x5	Offertax5	9,07 €	9,07 €	5	5
LDE00x10	Offertax10	8,62 €	8,62 €	10	5



Leva Clinica Debora Cromo

Codice	Riferimenti	Listino A	Listino B	Off.	Box
LCD00		15,53 €	15,53 €	1	5
LCD00x5	Offertax5	14,50 €	14,50 €	5	5
LCD00x10	Offertax10	13,81 €	13,81 €	10	5



Mix Lavello Monof.
Alessia Cartuccia D. 35

Hydro.Sat™

Codice	Riferimenti	Listino A	Listino B	Off.	Box
MLMAE00		22,57 €	22,57 €	1	5
MLMAE00x5	Offertax5	21,38 €	21,38 €	5	5
MLMAE00x10	Offertax10	20,31 €	20,31 €	10	5
MLMAE00x15	Offertax15	19,24 €	19,24 €	15	5



Mix Lavello Mon. Later.
Debora Canna Alta Pesante
Cromo

by GAY
rubinetterie

Codice	Riferimenti	Listino A	Listino B	Off.	Box
MLMLDE00		45,36 €	45,36 €	1	5
MLMLDE00x5	Offertax5	42,34 €	42,34 €	5	5
MLMLDE00x10	Offertax10	40,32 €	40,32 €	10	5
MLMLDE00x15	Offertax15	37,30 €	37,30 €	15	5



Mix Cucina Leva Laterale
Canna Conica Cm. 28 Granito -
Avena

WTS GROUP
ZIPPONI

Codice	Riferimenti	Listino A	Listino B	Off.	Box
AA620GA10LZ		86,47 €	86,47 €	1	5
AA620GA10LZx5	Offertax5	80,70 €	80,70 €	5	5
AA620GA10LZx10	Offertax10	76,86 €	76,86 €	10	5
AA620GA10LZx15	Offertax15	71,10 €	71,10 €	15	5



Mix Lavello Mon. Debora
Granito Rosa

Hydro.Sat™

Codice	Riferimenti	Listino A	Listino B	Off.	Box
MLMLDE82		79,76 €	79,76 €	1	5
MLMLDE82x5	Offertax5	74,44 €	74,44 €	5	5
MLMLDE82x10	Offertax10	70,90 €	70,90 €	10	5
MLMLDE82x15	Offertax15	65,58 €	65,58 €	15	5



Mix Lav. Mon. Malibu' Q Cr

ARMANDO
VICARIO

Codice	Riferimenti	Listino A	Listino B	Off.	Box
MALIBUQ00		39,69 €	39,69 €	1	5
MALIBUQ00x5	Offertax5	37,04 €	37,04 €	5	5
MALIBUQ00x10	Offertax10	35,28 €	35,28 €	10	5
MALIBUQ00x15	Offertax15	32,63 €	32,63 €	15	5



Mix Lav. Mon. Malibu' Due P
Cr

ARMANDO
VICARIO

Codice	Riferimenti	Listino A	Listino B	Off.	Box
MALIBU2P00		39,69 €	39,69 €	1	5
MALIBU2P00x5	Offertax5	37,04 €	37,04 €	5	5
MALIBU2P00x10	Offertax10	35,28 €	35,28 €	10	5
MALIBU2P00x15	Offertax15	32,63 €	32,63 €	15	5



Mix Lav. Fo-20-Re Cromo
Leva Chiusa

ARMANDO
VICARIO

Codice	Riferimenti	Listino A	Listino B	Off.	Box
FO20RE		48,20 €	48,20 €	1	5
FO20REx5	Offertax5	44,98 €	44,98 €	5	5
FO20REx10	Offertax10	42,84 €	42,84 €	10	5
FO20REx15	Offertax15	39,63 €	39,63 €	15	5



Mix Lav. 110 Cromo Leva
Aperta

ARMANDO
VICARIO

Codice	Riferimenti	Listino A	Listino B	Off.	Box
110FMIX		48,20 €	48,20 €	1	5
110FMIX5	Offertax5	44,98 €	44,98 €	5	5
110FMIXx10	Offertax10	42,84 €	42,84 €	10	5
110FMIXx15	Offertax15	39,63 €	39,63 €	15	5



Mix Lavello Mon. Canna Alta
Pesante Cromo

Codice	Riferimenti	Listino A	Listino B	Off.	Box
MLMLANR00		93,56 €	93,56 €	1	5
MLMLANR00x5	Offertax5	87,32 €	87,32 €	5	5
MLMLANR00x10	Offertax10	83,16 €	83,16 €	10	5
MLMLANR00x15	Offertax15	76,92 €	76,92 €	15	5



Mix Cucina Leva Laterale P

WTS GROUP
ZIPPONI

Codice	Riferimenti	Listino A	Listino B	Off.	Box
AA622CR10LZ		68,04 €	68,04 €	1	5
AA622CR10LZx5	Offertax5	63,50 €	63,50 €	5	5
AA622CR10LZx10	Offertax10	60,48 €	60,48 €	10	5
AA622CR10LZx15	Offertax15	55,94 €	55,94 €	15	5



Mix Lav. Mon.
Liberty Cromo Con Bocca
Girevole Mm.
260



FARIS™

BUGATTI
SANITARY-TAPS

Codice	Riferimenti	Listino A	Listino B	Off.	Box
7695CR		100,44 €	100,44 €	1	5
7695CRx5	Offertax5	93,75 €	93,75 €	5	5
7695CRx10	Offertax10	89,28 €	89,28 €	10	5
7695CRx15	Offertax15	82,59 €	82,59 €	15	5



Mix Lav.Mon.Liberty Bronzo Con
Bocca Girevole Mm. 260



FARIS™

BUGATTI
SANITARY-TAPS

Codice	Riferimenti	Listino A	Listino B	Off.	Pz
7695VO		155,78 €	155,78 €	1	5
7695VOx5	Offertax5	145,40 €	145,40 €	5	5
7695VOx10	Offertax10	138,47 €	138,47 €	10	5
7695VOx15	Offertax15	128,09 €	128,09 €	15	5



Mix Lav. Mon. Luxor Cromo Con
Bocca Girevole Mm. 302

FARIS™

BUGATTI
SANITARY-TAPS

Codice	Riferimenti	Listino A	Listino B	Off.	Box
0170CR		297,28 €	297,28 €	1	5
0170CRx5	Offertax5	277,46 €	277,46 €	5	5
0170CRx10	Offertax10	264,25 €	264,25 €	10	5
0170CRx15	Offertax15	244,43 €	244,43 €	15	5



Mix Lav. Mon.
Quadric Cromo Con Bocca
Girevole Mm.
320



FARIS™

BUGATTI
SANITARY-TAPS

Codice	Riferimenti	Listino A	Listino B	Off.	Pz
16720CR		199,90 €	199,90 €	1	5
16720CRx5	Offertax5	186,57 €	186,57 €	5	5
16720CRx10	Offertax10	177,69 €	177,69 €	10	5
16720CRx15	Offertax15	164,36 €	164,36 €	15	5



Mix Lav. Mon. Mix/54 Cromo
Canna A Ponte



ARMANDO
VICARIO

Codice	Riferimenti	Listino A	Listino B	Off.	Box
MIX5400		96,39 €	96,39 €	1	5
MIX5400x5	Offertax5	89,96 €	89,96 €	5	5
MIX5400x10	Offertax10	85,68 €	85,68 €	10	5
MIX5400x15	Offertax15	79,25 €	79,25 €	15	5



Mix Lavello Mon. Lake Cromo
Con Bocca Girevole Fusa
Mm.318

FARIS™

BUGATTI
SANITARY-TAPS

Codice	Riferimenti	Listino A	Listino B	Off.	Pz
0175CR		189,64 €	189,64 €	1	5
0175CRx5	Offertax5	177,00 €	177,00 €	5	5
0175CRx10	Offertax10	168,57 €	168,57 €	10	5
0175CRx15	Offertax15	155,92 €	155,92 €	15	5



Mix Lav. Mon.
Mix/62 Sf Cr
C/Canna Reclinabile
Sottofinestra

ARMANDO
VICARIO

Codice	Riferimenti	Listino A	Listino B	Off.	Box
MIX62SF00		153,77 €	153,77 €	1	5
MIX62SF00x5	Offertax5	143,52 €	143,52 €	5	5
MIX62SF00x10	Offertax10	136,68 €	136,68 €	10	5
MIX62SF00x15	Offertax15	126,43 €	126,43 €	15	5



Mix Lav.Mon.Mix/20
Sf Bronzo Dis.In
Cer.Can.Ponte
Sottofinestra

ARMANDO
VICARIO

Codice	Riferimenti	Listino A	Listino B	Off.	Pz
MIX20SF47		213,56 €	213,56 €	1	5
MIX20SF47x5	Offertax5	199,32 €	199,32 €	5	5
MIX20SF47x10	Offertax10	189,83 €	189,83 €	10	5
MIX20SF47x15	Offertax15	175,59 €	175,59 €	15	5



Miscelatore Set cucina Con
Molla com Soffione Sd4011

SPHERA
DOCCE & ACCESSORI

Codice	Riferimenti	Listino A	Listino B	Off.	Box
RU0011003CR		214,33 €	214,33 €	1	5
RU0011003CRx5	Offertax5	200,04 €	200,04 €	5	5
RU0011003CRx10	Offertax10	190,51 €	190,51 €	10	5
RU0011003CRx15	Offertax15	176,22 €	176,22 €	15	5

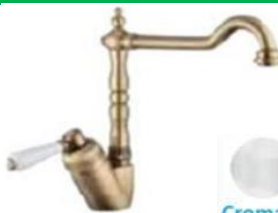

Mix Lavello Mon. Mix/56 Cr Con
Canna Old Fashion

ARMANDO
VICARIO

Codice	Riferimenti	Listino A	Listino B	Off.	Pz
MIX5600		107,73 €	107,73 €	1	5
MIX5600x5	Offertax5	100,55 €	100,55 €	5	5
MIX5600x10	Offertax10	95,76 €	95,76 €	10	5
MIX5600x15	Offertax15	88,58 €	88,58 €	15	5



Mix Lavello Mon. Lat. Debora
Bianco

Codice	Riferimenti	Listino A	Listino B	Off.	Box
MLMLDE04		41,89 €	41,89 €	1	6



Mix Lavello Monoforo "Debora"
Canna Alta Tubo Squadra Terra
Di Francia Cod. Interno
400217Vic00Td



Codice	Riferimenti	Listino A	Listino B	Off.	Box
MLMLDE100		71,82 €	71,82 €	1	6



Mix Lavello Monof.
Alessia

Codice	Riferimenti	Listino A	Listino B	Off.	Box
MLMAE00		22,57 €	22,57 €	1	6



Mix Debora Lav. Mon. C
/Bassa

Codice	Riferimenti	Listino A	Listino B	Off.	Box
MLMDDE00		29,74 €	29,74 €	1	6



Mix Lavello Mon.
Debora Canna Bassa
Attacco Lavatrice



Codice	Riferimenti	Listino A	Listino B	Off.	Box
AA609CR10LZ		72,92 €	72,92 €	1	6



Mix Lavello Mon.
Diretta Debora
Canna Bassa

Codice	Riferimenti	Listino A	Listino B	Off.	Box
MLMDDE00		83,13 €	83,13 €	1	6



Miscelatore cucina per filtro
d'acqua potabile acciaio inox
linea osmosi o acqua diretta



Codice	Riferimenti	Listino A	Listino B	Off.	Box
52691		94,19 €	94,19 €	1	6



Mix Lavello Monoforo
"Debora" Canna Alta Tubo
Pesante

Codice	Riferimenti	Listino A	Listino B	Off.	Box
MLMLLPDE00		100,71 €	100,71 €	1	6



Mix Lavello Parete Debora Cr.



Codice	Riferimenti	Listino A	Listino B	Off.	Box
MLPDE00	Cromo	42,51 €	42,51 €	1	6



Mix Debora Lavello Monof.
Canna Alta Pes. Gran. Beige



Codice	Riferimenti	Listino A	Listino B	Off.	Box
MLMLDE85	Avena	50,12 €	50,12 €	1	6

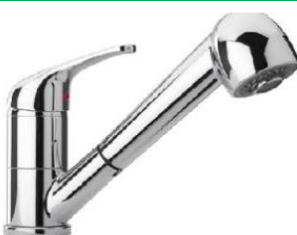

Mix Lav. Mon. Doc
/Estr. Debora Cartuccia 40



Codice	Riferimenti	Listino A	Listino B	Off.	Box
MLMEDE00	Cromo	97,59 €	97,59 €	1	6



Mix Lavello Mon. Debora Lux
Canna Old Fashion



Codice	Riferimenti	Listino A	Listino B	Off.	Box
MLMLOF00	Cromo	116,18 €	116,18 €	1	6



Mix Lavabo Drewi Cartuccia 40 Completo Import



Import Export

Codice	Riferimenti	Listino A	Listino B	Off.	Box
JH-8091	Cromo	38,34 €	42,56 €	1	6



Mix Vasca Drewi Cartuccia 40 Completo Import

Import Export

Codice	Riferimenti	Listino A	Listino B	Off.	Box
JH-8092	Cromo	35,50 €	39,41 €	1	6



Miscelatore Lavello Canna Alta

Import Export

Codice	Riferimenti	Listino A	Listino B	Off.	Box
JH-8065	Cromo	24,14 €	26,80 €	1	6



Mix Lavello Cucina Drewi Cartuccia 40 Import Zx

Import Export

Codice	Riferimenti	Listino A	Listino B	Off.	Box
JH-8095W	Cromo	34,08 €	37,83 €	1	6



Mix Lavello Cucina Canna Alta Drewi Cartuccia 40 Avena Import

Import Export

Codice	Riferimenti	Listino A	Listino B	Off.	Box
JH-8195D	Avena	36,92 €	40,98 €	1	12



Mix Lavello Cucina Drewi Cartuccia 40 Import

Import Export

Codice	Riferimenti	Listino A	Listino B	Off.	Box
JH-1586	Cromo	26,98 €	29,95 €	1	12



Miscelatore canna Orientabile

Import Export



Mix Bidet Drewi Cartuccia 40 Completo Import



Import Export

Codice	Riferimenti	Listino A	Listino B	Off.	Box
JH-8099	Cromo	39,76 €	44,13 €	1	6



Mix Lavello Cucina Drewi Cartuccia 40 Import

Import Export

Codice	Riferimenti	Listino A	Listino B	Off.	Box
JH-8095D	Cromo	36,92 €	40,98 €	1	6



Mix Lavello Cucina Drivei Cartuccia 40 Import Zx

Import Export

Codice	Riferimenti	Listino A	Listino B	Off.	Box
JH-8063	Cromo	34,08 €	37,83 €	1	6



Mix Lavello Cucina Inox Drewi Cartuccia 40 Import

Import Export

Codice	Riferimenti	Listino A	Listino B	Off.	Box
S9008	Cromo	42,60 €	47,29 €	1	6



Mix Lavello Cucina Drivei Cartuccia 40 Doccetta Estraibile Avena Import

Import Export

Codice	Riferimenti	Listino A	Listino B	Off.	Box
JH-8816	Avena	42,60 €	47,29 €	1	12



Miscelatore Lavello Pietra Sabbia

Import Export

Codice	Riferimenti	Listino A	Listino B	Off.	Box
JH-1585	Avena	42,60 €	47,29 €	1	12

Codice	Riferimenti	Listino A	Listino B	Off.	Box
814-1	NERO	38,34 €	42,56 €	1	12
814-2	BLUE	38,34 €	42,56 €	1	12
814-3	VERDE	38,34 €	42,56 €	1	12
814-4	ARANCIO	38,34 €	42,56 €	1	12
814-5	BIANCO	38,34 €	42,56 €	1	12
814-6	FUXIA	38,34 €	42,56 €	1	12



Gruppo Lavello Parete
Bronzo Francesca



Bronzato

Codice	Riferimenti	Listino A	Listino B	Off.	Box
GLPF47	Bronzo	101,65 €	101,65 €	1	12

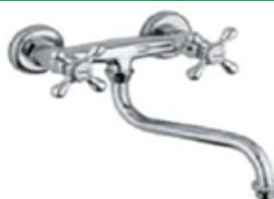

Gruppo Lavello Parete Cromo
Francesca



Cromato

Codice	Riferimenti	Listino A	Listino B	Off.	Box
GLPF00	Cromo	76,24 €	76,24 €	1	12



Gruppo Lavello Parete
Francesca

Codice	Riferimenti	Listino A	Listino B	Off.	Box
GLPF100	T-Francia	95,19 €	95,19 €	1	12

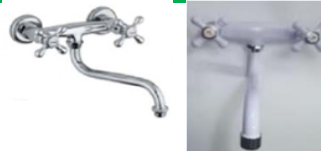

Gruppo Lavello Parete
Francesca Colore Bianco
Cromo

Codice	Riferimenti	Listino A	Listino B	Off.	Box
GLPF04	Bianco	95,19 €	95,19 €	1	12

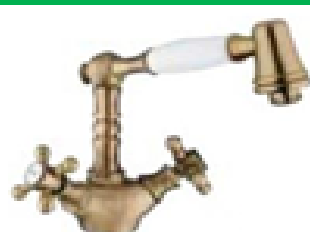

Gruppo Lavello Mon. D /Estr.
2 G. Bronzo Francesca



Bronzato

Codice	Riferimenti	Listino A	Listino B	Off.	Box
GLMAEF47	Bronzo	206,25 €	206,25 €	1	12



Gruppo Lavello Mon. D /Estr.
2 G. Cromo Francesca



Cromato

Codice	Riferimenti	Listino A	Listino B	Off.	Box
GLMAEF00	Cromo	157,07 €	157,07 €	1	12



Gruppo Lavello
Mono.B/Antica Francesca
Cromo



Cromato

Codice	Riferimenti	Listino A	Listino B	Off.	Box
GLMAF00	Cromo	103,09 €	103,09 €	1	12



Gruppo Lavello Mon.
B/Antica Francesca Rame

Codice	Riferimenti	Listino A	Listino B	Off.	Box
GLMAF65	Rame	143,64 €	143,64 €	1	12



Gruppo Lav. Mon. Francesca
Acqua Diretta Bronzato
Canna Ponte



Bronzato

Codice	Riferimenti	Listino A	Listino B	Off.	Box
GLMDF47	Bronzo	107,09 €	107,09 €	1	12

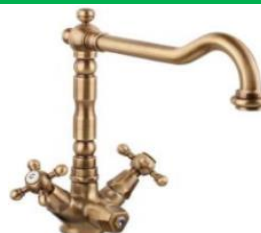

Gruppo Lavello Mon. B
/Antica Bronzo Acqua Diretta
Francesca



Bronzato

Codice	Riferimenti	Listino A	Listino B	Off.	Box
GLMADF47	Bronzo	166,58 €	166,58 €	1	12



Gruppo Lavello Mon. C/Fusa
Tiziana



Cromato

Codice	Riferimenti	Listino A	Listino B	Off.	Box
GLMFT	Cromo	46,46 €	46,46 €	1	12



Gruppo Lavello Mon. C
/Lusso Pesante Alta Tiziana



Cromato

Codice	Riferimenti	Listino A	Listino B	Off.	Box
GLMFAT	Cromo	39,14 €	39,14 €	1	12



Gruppo Lavello Monoforo
Jota



Codice	Riferimenti	Listino A	Listino B	Off.	Box
GLMJT00	Cromo	44,82 €	44,82 €	1	12



Gruppo Lavello Parete
Attacco Lavatrice Canna "U"



Codice	Riferimenti	Listino A	Listino B	Off.	Box
GLPLUT	Cromo	63,25 €	63,25 €	1	12



Rubinetto Rov. C /Snodo "U"
Tiziana 1/2"



Codice	Riferimenti	Listino A	Listino B	Off.	Box
RRUT	Cromo	24,04 €	24,04 €	1	10



Rubinetto Colonna Bar
Tiziana



Codice	Riferimenti	Listino A	Listino B	Off.	Box
RCBT	Cromo	23,04 €	23,04 €	1	6



Rubinetto Snodo + Lav.
Tiziana



Codice	Riferimenti	Listino A	Listino B	Off.	Box
RRBTE	Cromo	24,77 €	24,77 €	1	10



Gruppo Lavello
Mon.Francesca Bz. Bronzo
Canna Ponte



Codice	Riferimenti	Listino A	Listino B	Off.	Box
GLMF47	Bronzo	107,09 €	107,09 €	1	6



Gruppo Lavello Parete Tiziana



Codice	Riferimenti	Listino A	Listino B	Off.	Box
GLPT	Cromo	42,51 €	42,51 €	1	12



Gruppo Lavello Pareteattacco
Lavatrice Canna "E"



Codice	Riferimenti	Listino A	Listino B	Off.	Pz
GLPLT	Cromo	63,25 €	63,25 €	1	12



Rubinetto A Snodo Tiziana



Codice	Riferimenti	Listino A	Listino B	Off.	Pz
RRT	Cromo	24,04 €	24,04 €	1	10



Gruppo Lavabo Tiziana Sc.1"



Codice	Riferimenti	Listino A	Listino B	Off.	Pz
GLT	Cromo	62,21 €	62,21 €	1	6



Combin.Bidet Tiziana Sc.1"



Codice	Riferimenti	Listino A	Listino B	Off.	Box
CBT	Cromo	37,95 €	37,95 €	1	6



Gruppo Lavabo Mon. Tiziana



Codice	Riferimenti	Listino A	Listino B	Off.	Box
GLMT	Cromo	31,37 €	31,37 €	1	6



Rubinetto Biuso 1/2" Tiziana
Ec Rbe00

Codice	Riferimenti	Listino A	Listino B	Off.	Box
RBTE		12,34 €	12,34 €	1	12
RBTE _{x12}	Offertax12	11,69 €	11,69 €	12	12



Rubinetto Biuso 1/2" Tiziana
P.

Codice	Riferimenti	Listino A	Listino B	Off.	Box
RBPT		20,82 €	20,82 €	1	10
RBPT _{x10}	Offertax10	19,72 €	19,72 €	10	10



Rubinetto Full 1/2" Marziano

Codice	Riferimenti	Listino A	Listino B	Off.	Box
RF12		10,52 €	10,52 €	1	12
RF12 _{x12}	Offertax12	9,97 €	9,97 €	12	12



Rubinetto Sing.C/Aeratore
1/2"

Codice	Riferimenti	Listino A	Listino B	Off.	Box
RAT		21,55 €	21,55 €	1	10
RAT _{x10}	Offertax10	20,41 €	20,41 €	10	10



Rubinetto Ful 1/2" Port.
Marz.

Codice	Riferimenti	Listino A	Listino B	Off.	Box
RF12P		13,81 €	13,81 €	1	12
RF12P _{x12}	Offertax12	12,34 €	12,34 €	12	12



Rubinetto Singolo 1/2" S/P
Tiz.

Codice	Riferimenti	Listino A	Listino B	Off.	Pz
RT		19,17 €	19,17 €	1	10
RT _{x10}	Offertax10	18,16 €	18,16 €	10	10



Rubinetto 1/2 C/Vitone
Rapido 1/4 Di Giro Leva

Codice	Riferimenti	Listino A	Listino B	Off.	Box
669		11,58 €	11,58 €	1	6
669 _{x6}	Offertax6	10,97 €	10,97 €	6	6



Rubinetto Vitone Rapido D.
1/2" Cromato Idral Leva
Pesante In Ottone

Codice	Riferimenti	Listino A	Listino B	Off.	Box
RVRLC12		15,76 €	15,76 €	1	6
RVRLC12 _{x6}	Offertax6	14,93 €	14,93 €	6	6



Rubinetto Diritto Da 1/2 Con
Rompigetto Cromo

Codice	Riferimenti	Listino A	Listino B	Off.	Box
667		11,85 €	11,85 €	1	6
667 _{x10}	Offertax10	11,23 €	11,23 €	10	6



Gruppetto Sottoboiler 1/2"
Cromo

Codice	Riferimenti	Listino A	Listino B	Off.	Box
GSTE		18,77 €	18,77 €	1	6
GSTEx6	Offertax6	17,78 €	17,78 €	6	6



Rubinetto Collo Cigno 1/2"
Tiz.

Codice	Riferimenti	Listino A	Listino B	Off.	Box
RCT		22,89 €	22,89 €	1	6
RCT _{x6}	Offertax6	21,69 €	21,69 €	6	6



Rubinetto Incasso Tiziana
1/2"

Codice	Riferimenti	Listino A	Listino B	Off.	Box
RIT		20,20 €	21,41 €	1	6
RIT _{x6}	Offertax6	19,14 €	20,28 €	6	6



Rubinetto Artistico 1/2"
Vitone

Codice	Riferimenti	Listino A	Listino B	Off.	Box
RA1\2V		24,89 €	26,38 €	1	6
RA1\2Vx6	Offertax6	23,58 €	24,99 €	6	6



Rubinetto Artistico 1/2" Sfera

Codice	Riferimenti	Listino A	Listino B	Off.	Box
RA1\2S		27,22 €	28,85 €	1	6
RA1\2Sx6	Offertax6	25,86 €	27,41 €	6	6



Rubinetto Pulsante Fontana

Codice	Riferimenti	Listino A	Listino B	Off.	Box
RPFGL		26,69 €	28,30 €	1	6
RPFGLx6	Offertax6	24,02 €	25,47 €	6	6



Coppia Retrogruppo X Lav.
3/4"

Codice	Riferimenti	Listino A	Listino B	Off.	Box
CRL3\4		9,31 €	9,87 €	1	6
CRL3\4x6	Offertax6	8,82 €	9,35 €	6	6



Retrogruppo C/Ghiera Girev.

Codice	Riferimenti	Listino A	Listino B	Off.	Box
RGG		10,18 €	10,79 €	1	6
RGGx6	Offertax6	9,64 €	10,22 €	6	6



Rubinetto Biuso Lav+Lav A Y

Codice	Riferimenti	Listino A	Listino B	Off.	Box
RBLYT		24,87 €	26,36 €	1	5
RBLYTx5	Offertax5	Arrivo	Arrivo	5	5



Rubinetto Sq. Lav. 1/2" X
3/4" Angolo Orientale

Codice	Riferimenti	Listino A	Listino B	Off.	Box
RLAOV00		4,85 €	5,14 €	1	6
RLAOV00x6	Offertax6	4,59 €	4,87 €	6	6



Copp.Distanz.Ott.Crom.3/4X3
/4 Con E Senza Foro 3/8 Mf

Codice	Riferimenti	Listino A	Listino B	Off.	Pz
CDF00		4,36 €	4,62 €	1	6
CDF00x6	Offertax6	4,13 €	4,38 €	6	6



Coppia Distanz Ottone
Cromato Dado Girevole Con E
Senza Foro

Codice	Riferimenti	Listino A	Listino B	Off.	Pz
CDDG00		7,56 €	8,01 €	1	6
CDDG00x6	Offertax6	7,16 €	7,59 €	6	6



Rubinetto Sfera Lavatrice Pes.

Codice	Riferimenti	Listino A	Listino B	Off.	Box
RSLP		6,70 €	7,10 €	1	10
RSLPx10	Offertax10	6,34 €	6,72 €	10	10



Rubinetto Sfera Lavatrice D.
1/2"X3(4"

Codice	Riferimenti	Listino A	Listino B	Off.	Box
RSL		5,99 €	6,34 €	1	10
RSLx10	Offertax10	5,39 €	5,71 €	10	10



Rubinetto Sfera Lavatrice
Bibo

Codice	Riferimenti	Listino A	Listino B	Off.	Box
RSLB		7,93 €	8,41 €	1	10
RSLBx10	Offertax10	7,51 €	7,97 €	10	10



Vitone Ceramico 90° 1/2" Freddo

Codice	Rif.	Listino A	Listino B
V12C90F	Freddo	6,89 €	7,65 €
V12C90C	Caldo	6,89 €	7,65 €



Vitone 1/2" Doppio Filetto

Codice	Rif.	Listino A	Listino B
V12D	D. 1/2"	3,44 €	3,82 €



Vitone Ricambio Da 3/8" H. 20

Codice	Rif.	Listino A	Listino B
V318	D. 3/8"	1,66 €	1,84 €
V12	D. 1/2"	2,88 €	3,20 €



Vitone Rubinetti

Codice	Rif.	Listino A	Listino B
V1919	19/19	6,38 €	7,08 €
V1819	18/19	5,92 €	6,58 €



Maniglia Ottonecrom. Rub. Freddo

Codice	Rif.	Listino A	Listino B
MRTF	FREDDA	4,08 €	4,53 €



Maniglia Ottone Crom. Rub. Calda

Codice	Rif.	Listino A	Listino B
MRTC	CALDA	4,08 €	4,53 €



Cartuccia Da 25 Bassa

Codice	Rif.	Listino A	Listino B
CM25B	D. 25	3,59 €	3,99 €



Cartuccia Da 25 Alta

Codice	Rif.	Listino A	Listino B
CM25A	D. 25	3,59 €	3,99 €



Cartuccia Bassa Da 35

Codice	Rif.	Listino A	Listino B
C35B	D. 35	3,39 €	3,76 €



Cartuccia Alta Da 35

Codice	Rif.	Listino A	Listino B
C35A	D. 35	3,39 €	3,76 €

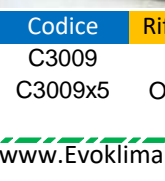

Cartuccia Nicolazzi

Codice	Riferimenti	Listino A	Listino B	Off.	Box
C3009		70,88 €	70,88 €	1	5
C3009x5	Offertax5	63,25 €	63,25 €	5	10



Colonnina Bordo Vasca Cromo

Codice	Rif.	Listino A	Listino B
CBV00	Cromo	5,74 €	6,37 €



Colonnina Bordo Vasca Fissa

Codice	Rif.	Listino A	Listino B
CBVF00	Cromo	4,82 €	5,35 €



Eccentrico Per Gruppo 4 Cm.

Codice	Riferimenti	Listino A	Listino B
EGU4	4 cm	8,02 €	8,90 €
EGU6	6 cm	4,59 €	5,10 €



Eccentrico X Gruppo Univ. Crom

Codice	Rif.	Listino A	Listino B
EGU	Cromo	2,30 €	2,55 €



Eccentrico Gruppo Univirsale Bronzo

Codice	Rif.	Listino A	Listino B
EGU47	Bronzo	5,51 €	6,12 €



Eccentrico X Gruppo H. 50 Pezzo

Codice	Rif.	Listino A	Listino B
EGULDG	Cromo	6,59 €	7,31 €



Snodino Semplice In Ottone Cr.

Codice	Rif.	Listino A	Listino B
SSO	Cromo	0,76 €	0,84 €



Snodino Nylon Econ.

Codice	Rif.	Listino A	Listino B
SNE	Nylon	0,26 €	0,28 €



Snodino Doppio In Ottone Cr.

Codice	Rif.	Listino A	Listino B
SDO	Cromo	2,02 €	2,24 €



Bocca Di Erogazione A Parete Attacco 3/4" Con Deviatore 1/2"

Codice	Rif.	Listino A	Listino B
BEPDG00	Cromo	76,20 €	76,20 €
BEPDG00x6	Off.x6	73,48 €	73,48 €



Bocca Di Erogazione Parete 3/4"

Codice	Rif.	Listino A	Listino B
BEPG00	Cromo	57,15 €	57,15 €
BEPG00x6	Off.x6	55,11 €	55,11 €



Bocca Erogazione a biscotto pesante

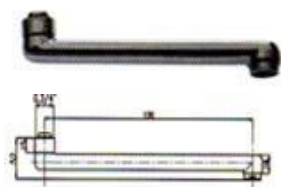

Codice	Riferimenti	Listino A	Listino B	Off.	Box
BOMC12	Cromo CM. 12	16,07 €	17,84 €	1	12
BOMC15	Cromo CM. 15	7,96 €	8,84 €	1	12
BOMC20	Cromo CM. 20	16,53 €	18,35 €	1	12
BOMC25	Cromo CM. 25	17,08 €	18,96 €	1	12
BOMC20E	cm 20 EXPO	14,15 €	15,70 €	1	12

Canna Alta Ombrello D.24 H 280X230



Codice	Riferimenti	Listino A	Listino B	Off.	Box
HY-G2402		13,92 €	15,45 €	1	12
HY-G2402x6	Offertax6	11,86 €	13,17 €	6	12

Canna Alta A Tubo Per Lavabo Da Mm Da 220X170 Mm Girevole



Codice	Riferimenti	Listino A	Listino B	Off.	Box
HY-G2404		10,05 €	11,16 €	1	12
HY-G2404x6	Offertax6	8,57 €	9,52 €	6	12

Canna Telescopica D. 18 Est. Da 200 A 300 Mm



Codice	Riferimenti	Listino A	Listino B	Off.	Box
I-09500SE		30,00 €	33,30 €	1	12
I-09500SEx6	Offertax6	25,58 €	28,40 €	6	12

Canna Lav. Univ."U"Cr 18X20



Codice	Riferimenti	Listino A	Listino B	Off.	Box
CUU20		7,62 €	8,45 €	1	12
CUU20x6	Offertax6	6,49 €	7,21 €	6	12

Bocca Girevole Tubo Sagomato Dado 3/4" Pesante



Import Export

Codice	Riferimenti	Listino A	Listino B	Off.	Box
HY-263G		19,39 €	21,52 €	1	12
HY-263Gx6	Offertax6	18,37 €	20,39 €	6	12

Bocca Girevole Fusa Pesante



Codice	Riferimenti	Listino A	Listino B	Off.	Box
HY-266G		25,21 €	27,98 €	1	12
HY-266Gx6	Offertax6	23,88 €	26,51 €	6	12

Canna Alta A Tubo Per Lavabo Da Mm Da 230X190 Mm Girevole

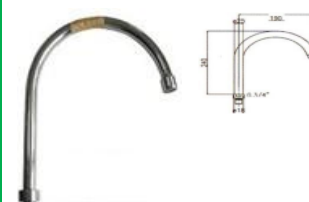

Codice	Riferimenti	Listino A	Listino B	Off.	Box
HY-G2403		12,66 €	14,05 €	1	12
HY-G2403x6	Offertax6	10,79 €	11,98 €	6	12

Canna Univ. Jota 3/4"X20



Codice	Riferimenti	Listino A	Listino B	Off.	Box
CJU20		7,38 €	8,19 €	1	12
CJU20x6	Offertax6	6,29 €	6,98 €	6	12

Canna Universale Cm. 20 Con Bocca Orientabile



Codice	Riferimenti	Listino A	Listino B	Off.	Box
CBR20		6,34 €	7,04 €	1	12
CBR20x6	Offertax6	5,41 €	6,00 €	6	12

Canna Universale A Esse 3/4" X 20Cm.



Codice	Riferimenti	Listino A	Listino B	Off.	Box
CUE20		6,92 €	7,68 €	1	12
CUE20x6	Offertax6	5,90 €	6,55 €	6	12



Flussometro Inc. Da 3/4" Cr.



Codice	Riferimenti	Listino A	Listino B	Off.	Box
F3\400	D. 3/4"	42,50 €	47,17 €	1	10
F100	D. 1"	47,32 €	52,53 €	1	10



Flussometro Esterno 3/4" Cr.



Codice	Riferimenti	Listino A	Listino B	Off.	Box
FE3\400	D. 3/4"	42,10 €	46,73 €	1	10
FE100	D. 1"	44,03 €	48,88 €	1	10



Piastra Passo Rapido In Ottone Cromato H10X28 Mm 87X135



Codice	Riferimenti	Listino A	Listino B	Off.	Box
2912F04		3,71 €	4,11 €	1	10
2912F04x5	Offertax5	3,51 €	3,90 €	5	10
2912F04x10	Offertax10	3,34 €	3,70 €	10	10
2912F04x15	Offertax15	3,16 €	3,51 €	15	10

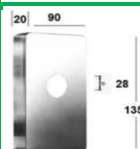

Piastra Passo Rapido In Ottone Cromato H20X28 Mm 87X135



Codice	Riferimenti	Listino A	Listino B	Off.	Box
2912F07		4,52 €	5,02 €	1	10
2912F07x5	Offertax5	4,29 €	4,76 €	5	10
2912F07x10	Offertax10	4,07 €	4,52 €	10	10
2912F07x15	Offertax15	4,07 €	4,52 €	15	10



Placca Inox Per Flussometro

Codice	Riferimenti	Listino A	Listino B	Off.	Box
PIF	Inox	0,92 €	1,02 €	1	10
PIF5	Offertax5	0,87 €	0,96 €	5	10
PIF10	Offertax10	0,82 €	0,91 €	10	10
PIF15	Offertax15	0,78 €	0,87 €	15	10



Rosone X Fluss. Tondo 20X25



Codice	Riferimenti	Listino A	Listino B	Off.	Box
RFT20X25		2,26 €	2,51 €	1	10
RFT20X25x5	Offertax5	2,22 €	2,47 €	5	10
RFT20X25x10	Offertax10	2,18 €	2,41 €	10	10
RFT20X25x15	Offertax15	2,08 €	2,31 €	15	10



Blister Vitoni Rubinetto

Codice	Riferimenti	Listino A	Listino B	Off.	Box
090BVU		9,28 €	10,30 €	1	5
090BVUx5	Offertax5	8,79 €	9,76 €	5	5
090BVUx10	Offertax10	8,35 €	9,27 €	10	5
090BVUx15	Offertax15	7,91 €	8,78 €	15	5



Blister Vitoni Flussometri

Codice	Riferimenti	Listino A	Listino B	Off.	Box
091BUF		30,97 €	34,38 €	1	5
091BUFx5	Offertax5	29,34 €	32,57 €	5	5
091BUFx10	Offertax10	27,88 €	30,94 €	10	5
091BUFx15	Offertax15	26,41 €	29,31 €	15	5



Tubo Telescopico Flussometro Esterno Da 3/4" D. 25 Cromo

Codice	Riferimenti	Listino A	Listino B	Off.	Box
TTF3\4E00	D. 3/4"	18,37 €	20,39 €	1	5
TTF1E00	D. 1"	23,02 €	25,55 €	1	5

Vitone Compl. X Fluss. 32 V.33



Codice	Riferimenti	Listino A	Listino B	Off.	Box
VF26H33	D. 26	24,35 €	27,03 €	1	10
VF27H33	D. 27	24,35 €	27,03 €	1	10
VF28H33	D. 28	24,35 €	27,03 €	1	10
VF29H33	D. 29	24,35 €	27,03 €	1	10
VF30H33	D. 30	24,35 €	27,03 €	1	10
VF32H33	D. 32	27,85 €	30,92 €	1	10



Colonna Doccia El.Jet
Nero



Codice	Pz	Listino A	Listino B
CEJNE	1	607,26 €	607,26 €
CEJNEx2	2	546,53 €	546,53 €



Colonna Doccia
Magicconfort



Codice	Pz	Listino A	Listino B
CDMC	1	74,42 €	74,42 €
CDMCx5	5	66,98 €	66,98 €



Saliscendi Cromato Per
Doccia Serie Tempesta
Grohe
Asta Doccia 600Mm



Codice	Pz	Listino A	Listino B
27598001	1	70,40 €	70,40 €
27598001x5	5	65,71 €	65,71 €



Saliscendi Completo Dalia



Codice	Pz	Listino A	Listino B
DALIA	1	34,02 €	34,02 €
DALIAx5	5	30,62 €	30,62 €



Saliscendi Asta Ellittica
Con Portasapone E
Doccetta



Codice	Pz	Listino A	Listino B
KANDY	1	45,93 €	45,93 €
KANDYx5	5	43,09 €	43,09 €



Kit Soffione Doccia Asta 24/25

SOFFIONE
Diametro di 16 cm.
con getto a pioggia dolce

BRACCIO
Lunghezza 36 cm.

DEVIATORE
A 3 vie che permette di indirizzare il flusso dell'acqua dalla doccia al soffione e viceversa

FLESSIBILE
In acciaio inox inossidabile



Codice	Pz	Listino A	Listino B
59910	1	17,01 €	17,01 €
59910x5	5	15,31 €	15,31 €



Saliscendi Lilia Completa



Codice	Pz	Listino A	Listino B
LILIA	1	34,02 €	34,02 €
LILIAx5	5	30,62 €	30,62 €



New Saliscendi Docc.5
Getti Con Porta Sapone



Codice	Pz	Listino A	Listino B
ROSY	1	28,35 €	28,35 €
ROSYx5	5	25,52 €	25,52 €



Saliscendi Europa 4 Getti
Cr.



Codice	Pz	Listino A	Listino B
SE4GC	1	24,10 €	24,10 €
SE4GCx5	5	21,69 €	21,69 €



Set Doccia Cromo
Palinuro



Codice	Pz	Listino A	Listino B
110E84100	1	32,13 €	32,13 €
110E84100x2	2	30,24 €	30,24 €



Set Doccia Cromo Ischia



Codice	Pz	Listino A	Listino B
110E36100	1	22,76 €	22,76 €
110E36100x5	5	21,42 €	21,42 €



Saliscendi Magic Confort
Senza Asta Regolabile



Codice	Pz	Listino A	Listino B
SMC4GC	1	31,42 €	31,42 €
SMC4GCx5	5	29,77 €	29,77 €

Braccio Doccia Lusso Sezione Quadrata In Scatola



Codice	Pz	Listino A	Listino B
BD6042003CR	1	63,70 €	63,70 €
BD6042003CRx5	5	57,33 €	57,33 €

Braccio Doccia Lusso Cm.35



Codice	Pz	Listino A	Listino B
BD6048CR35	1	68,45 €	68,45 €
BD6048CR35x5	5	61,60 €	61,60 €

Saliscendi NEOS Doccia AMBRA in abs 4 funzioni cromata con sistema anticalcare autopulente



Codice	Pz	Listino A	Listino B
SL5N420T5CR	1	45,36 €	45,36 €
SL5N420T5CRx5	5	40,82 €	40,82 €



Braccio Doccia Sphera 6037
25 Cm

Codice	Riferimenti	Listino A	Listino B	Off.	Box
BD6037253CR	cm.25	12,25 €	13,59 €	1	12
BD6037303CR	cm.30	14,03 €	15,58 €	1	12
BD6037353CR	cm.35	14,42 €	16,01 €	1	12
BD6037403CR	cm.40	15,31 €	16,99 €	1	12



Braccio Doccia 25 Cm Import

Codice	Riferimenti	Listino A	Listino B	Off.	Box
DGO-08525	cm.25	5,44 €	6,04 €	1	12
DGO-08630	cm.30	5,67 €	6,29 €	1	12
DGO-08735	cm.35	5,90 €	6,55 €	1	12
DGO-08740	cm.40	Arrivo	Arrivo	1	12



Soffione Derby 20X20

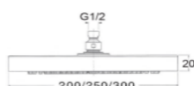

Codice	Riferimenti	Listino A	Listino B	Off.	Box
SD4914	cm.20	28,68 €	28,68 €	1	12
SD4924	cm.25	64,13 €	64,13 €	1	12
SD4934	cm.30	86,17 €	86,17 €	1	12



Soffione Minimale In Acciaio
Anticalcare Import Quadrato
10X10

Import Export

Codice	Riferimenti	Listino A	Listino B	Off.	Box
S-1040Q	10x10	5,39 €	5,98 €	1	12
S-1540Q	15x15	11,34 €	12,59 €	1	12
S-2040Q	20x20	17,01 €	18,88 €	1	12
S-2540Q	25x25	25,52 €	28,32 €	1	12



Soffione Tondo 20X20
Chelsea



Codice	Riferimenti	Listino A	Listino B	Off.	Box
SD3922	cm.20	20,16 €	22,38 €	1	12
SD3925	cm.25	42,91 €	47,63 €	1	12
SD3930	cm.30	Arrivo	Arrivo	1	12



Soffione Minimale In Acciaio
Anticalcare Import Tondo D.
10 Zx

Import Export

Codice	Riferimenti	Listino A	Listino B	Off.	Box
S-1040T	10x10	5,67 €	6,29 €	1	12
S-1540T	15x15	11,34 €	12,59 €	1	12
S-2040T	20x20	17,01 €	18,88 €	1	12
S-2540T	25x25	25,52 €	28,32 €	1	12



Duplex Glamour Fisso



Duplex Arte Fisso



RUIS12
Rubinetto per idroscopino in
ottone 1/2 M x 1/2
M con supporto doccia
(acqua fredda)

Codice	Pz	Listino A	Listino B	Codice	Pz	Listino A	Listino B	Codice	Pz	Listino A	Listino B
DP3064	1	35,04 €	38,90 €	DP3052	1	31,87 €	35,37 €	RUIS12	1	21,26 €	23,60 €
DP3064x5	5	31,54 €	35,01 €	DP3052x5	5	28,68 €	31,83 €	RUIS12x5	5	19,14 €	21,24 €



Doccia Parrucchiere 2
Getti



Doccia Trendy
Monoget. Antic. Linea
Minimale Quadrato



Doccia Star
Monoget. Antic. Tonda



Codice	Pz	Listino A	Listino B	Codice	Pz	Listino A	Listino B	Codice	Pz	Listino A	Listino B
DC5003	1	16,57 €	18,40 €	DC5056001CR	1	16,16 €	17,94 €	DC5039	1	14,41 €	15,99 €



Kit Braccio Doccia Con Soffione Serie Lux



FLEXTON

Codice	Pz	Listino A	Listino B
4010CR	1	30,24 €	30,24 €

Kit Braccio Doccia Con Soffione Serie Lux



FLEXTON

Codice	Pz	Listino A	Listino B
4001CR	1	30,24 €	30,24 €

Kit Braccio Doccia Con Soffione Serie Lux
Anticalcare



FLEXTON

Codice	Pz	Listino A	Listino B
4002CR	1	30,24 €	30,24 €

Kit Braccio Doccia Con Soffione Serie Lux
Maxi Perfecta



FLEXTON

Codice	Pz	Listino A	Listino B
4003CR	1	30,24 €	30,24 €

Doccetta Retta Ec. Bianca



Codice	Pz	Listino A	Listino B
DREB	1	2,70 €	2,70 €
DREN	1	2,70 €	2,70 €

DOCCETTA DOCCIA CON CURVETTA PER FORCELLA
CLASSICA



Codice	Pz	Listino A	Listino B
DCEN	1	3,29 €	3,29 €



Doccia Kit Marine Cromo
In Scatola Idromassaggio



Codice	Pz	Listino A	Listino B
DCKITM	1	11,58 €	11,58 €
DCKITMx5	5	10,67 €	10,67 €



Doccetta Primula Cromo
Ant.



Codice	Pz	Listino A	Listino B
DIGC	1	2,24 €	2,24 €



Doccetta Aurora 5 Getti
Cromato



Codice	Pz	Listino A	Listino B
AURORA	1	10,12 €	10,12 €



Doccia Shut Off Con
Fermo Leva Nera

Codice	Pz	Listino A	Listino B
DC5035N	1	4,48 €	4,48 €



Doccia Salome'

Codice	Pz	Listino A	Listino B
DC5009	1	20,05 €	20,05 €



Doccia Aladino Shut Off

Codice	Pz	Listino A	Listino B
DC5028	1	3,80 €	3,80 €



Gomito Saliscendi Mm
1/2" C.Ros

Codice	Pz	Listino A	Listino B
GS1\2	1	1,87 €	2,08 €
GS1\2x20	20	1,72 €	1,91 €



Pres a acqua in ottone
serie Glamour attacco
1/2" MM

Codice	Pz	Listino A	Listino B
PA3160003CR	1	19,99 €	19,99 €



Pres a acqua in ottone
modello Arte attacco
1/2" MM

Codice	Pz	Listino A	Listino B
PA3150003CR	1	4,10 €	4,10 €



Duplex Esterno Abs



Duplex Esterno Forcellino



Duplex Esterno Fuso

Codice	Pz	Listino A	Listino B
DP3033	1	1,08 €	1,20 €

Codice	Pz	Listino A	Listino B
DP3036	1	4,14 €	4,60 €

Codice	Pz	Listino A	Listino B
DP3034	1	5,72 €	6,34 €



Flex Doccia Da 150 Ff



Flex Doccia 150 Conico



Flex Monoforo 120
Conico 1/2" Cono 3/8"
Maschio

Codice	Pz	Listino A	Listino B
FD150	150	3,08 €	3,42 €
FD200	200	4,35 €	4,83 €

Codice	Pz	Listino A	Listino B
FD150C	150	3,68 €	4,08 €
FD200C	200	4,54 €	5,03 €

Codice	Pz	Listino A	Listino B
FM120C	1	5,04 €	5,59 €



Soffione Iris Anticalcare
Sac.



Soffione Standard 1/2"



Flex Doccia Estensibile
Scatola 150-200 Conico

Codice	Pz	Listino A	Listino B
S1GA	1	4,55 €	5,05 €

Codice	Pz	Listino A	Listino B
SS	1	5,57 €	6,18 €

Codice	Pz	Listino A	Listino B
FDE200S	1	6,91 €	7,67 €



Soffione A Campana
Anticalcare



Soffione Idromassaggio
Muoltigetti Easyclean
Pesante Cromato Lucido

FLEXTON



Soffione Idromassaggio
Muoltigetti Pesante
Cromato Lucido

FLEXTON

Codice	Pz	Listino A	Listino B
SD4075	1	7,23 €	8,02 €

Codice	Pz	Listino A	Listino B
0893CR	1	10,58 €	11,75 €

Codice	Pz	Listino A	Listino B
0892CR	1	9,58 €	10,63 €



Soffione Magic
Anticalcare



Soffione Ninfea 3 Getti
Anticalcare Cromato



Soffione Gardenia 5 Getti

Codice	Pz	Listino A	Listino B
SD4072	1	4,28 €	4,76 €

Codice	Pz	Listino A	Listino B
SD4062	1	14,87 €	16,50 €

Codice	Pz	Listino A	Listino B
SD4020	1	8,82 €	9,79 €



Cestino Carol Triplo Cromato



Cestino Carol Doppio Cromato



Cestino Carol Singolo Cromato

Codice	Pz	Listino A	Listino B	Codice	Pz	Listino A	Listino B	Codice	Pz	Listino A	Listino B
ACC13142	1	15,12 €	16,78 €	ACC13141	1	12,60 €	13,99 €	ACC13140	1	10,08 €	11,19 €



SHOWER LOCK ANGOLARE DOCCIA TRIPLO SATINATO



Angoliera Melanie Doppia Cromato



Angoliera Melanie Singola Cromato

Codice	Pz	Listino A	Listino B	Codice	Pz	Listino A	Listino B	Codice	Pz	Listino A	Listino B
101D14101	1	35,64 €	39,56 €	ACC13146	1	12,60 €	13,99 €	ACC13150	1	10,08 €	11,19 €



Cestello Grip



Angolare Doccia Bianco Oasi

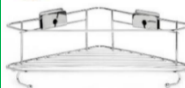

Angolare Doccia Grip



Codice	Pz	Listino A	Listino B	Codice	Pz	Listino A	Listino B	Codice	Pz	Listino A	Listino B
105G94100	1	20,59 €	22,85 €	101C17004	1	8,06 €	8,95 €	105G96100	1	24,39 €	27,08 €



Set Accessori Bagno Metaform Serie Otto/One



Kit Wind 4 Pezzi Cromo



Kit Wind 8 Pezzi Cromo



Codice	Pz	Listino A	Listino B	Codice	Pz	Listino A	Listino B	Codice	Pz	Listino A	Listino B
101757100	1	84,42 €	93,71 €	105L23100	1	47,88 €	53,15 €	101L02100	1	90,72 €	100,70 €



Porta Scopino Da Terra Cromo



Kit Linea 9 Pezzi Bianco



Kit Linea 4 Pezzi Cromo



Codice	Pz	Listino A	Listino B	Codice	Pz	Listino A	Listino B	Codice	Pz	Listino A	Listino B
101118100	1	11,84 €	13,15 €	101331004	1	60,48 €	67,13 €	110A46100	1	45,36 €	50,35 €



Asciugacapelli Da Parete
One Bia



Asciugamani Elettrico Rocket Bianco 1800 W



Seggiolino Vasca Con Schenale Regolabile In
Larghea



Codice	Pz	Listino A	Listino B
101906004	1	42,84 €	47,55 €

Codice	Pz	Listino A	Listino B
LFHD1E	1	67,50 €	74,92 €

Codice	Pz	Listino A	Listino B
15500	1	168,52 €	168,52 €
15500x2	2	154,76 €	154,76 €



Sgabello 4 Gambe Bianco

Seduta Ribaltabile Da Muro In Alluminio Verniciato E
Materiale Plastico Bianco



Seduta Per Vasca Regolabile Bianco



Codice	Pz	Listino A	Listino B
101H47602	1	47,88 €	53,15 €

Codice	Pz	Listino A	Listino B
101M52004	1	78,12 €	86,71 €

Codice	Pz	Listino A	Listino B
101H48602	1	124,69 €	138,41 €

Lavabo Ergonomico Disabilis/Troppo Pieno



Vaso Disabile
Scarico Terra



Sedile Ribaltabile Thermomat Saniline A
Parete



Codice	Pz	Listino A	Listino B
10192	1	155,27 €	155,27 €
10192x2	2	140,48 €	140,48 €

Codice	Pz	Listino A	Listino B
10200	1	155,21 €	155,21 €
10200x2	2	140,43 €	140,43 €

Codice	Pz	Listino A	Listino B
T-SPR	1	223,51 €	223,51 €
T-SPRx2	2	198,68 €	198,68 €

Vaso Alto Terza Eta' Scarico Pavimento



Vaso Disabile
Sc.Parete



Mensola Reclinabile Lavabo Art. 15101



Codice	Pz	Listino A	Listino B
10381	Vaso	165,73 €	183,95 €
10386	Bidet	165,73 €	183,95 €

Codice	Pz	Listino A	Listino B
10210	1	155,21 €	172,29 €
10210x2	2	140,43 €	155,88 €

Codice	Pz	Listino A	Listino B
15101	1	99,04 €	109,93 €



Specchio
Basculante Bianco



Mensola Pneumatica Reclinabile Art. 15102



Coppia Mensole Fisse Lavabo Art. 15100



Codice	Pz	Listino A	Listino B
101H21004	1	140,24 €	155,66 €
101H21004x2	2	133,56 €	148,25 €

Codice	Pz	Listino A	Listino B
15102	1	200,04 €	222,04 €

Codice	Pz	Listino A	Listino B
15100	1	44,19 €	49,05 €



Miscelatore A Due Pedali Per Montaggio A Pavimento.



Miscelatore Progressivo Monopedale Per Installazione A Pavimento

PEDALE MISCELATORE / PEDAL MIXER



Miscelatore a pedale temporizzato a parete/pavimento Self-closing pedal wall-mounted/floor-mounted mixer Mitigeur temporisé à pédale mural/au plancher. Art. 9010

Codice	Pz	Listino A	Listino B
M2PPI	1	126,30 €	126,30 €
M2PPIx5	5	117,88 €	117,88 €

Codice	Pz	Listino A	Listino B
MPPI	1	125,34 €	125,34 €
MPPIx5	5	116,98 €	116,98 €

Codice	Pz	Listino A	Listino B
9010	1	157,95 €	157,95 €

PEDALE MONOACQUA / PEDAL SINGLE-WATER TAP



101free



Rubinetto a pedale temporizzato a parete/pavimento Self-closing pedal wall-mounted/floor-mounted tap Robinet temporisé à pédale mural/au plancher. Art. 9057

PEDALE MONOACQUA / PEDAL SINGLE-WATER TAP



101free



Rubinetto a pedale temporizzato a parete/pavimento Self-closing pedal wall-mounted/floor-mounted tap Robinet temporisé à pédale mural/au plancher. Art. 9056

PEDALE ISTANTANEO / INSTANTANEOUS-FLOW PEDAL TAP



101free



Miscelatore a pedale istantaneo a parete/pavimento Instantaneous pedal wall-mounted/floor-mounted mixer Mitigeur instantané à pédale mural/au plancher. Art. 9011

Codice	Pz	Listino A	Listino B
9057	1	62,87 €	62,87 €

Codice	Pz	Listino A	Listino B
9056	1	92,55 €	92,55 €

Codice	Pz	Listino A	Listino B
9011	1	69,80 €	69,80 €

LAVELLO MISCELATORE / SINK MIXER



101free



Miscelatore lavabo elettronico con canna girevole con alimentazione a batteria Electronic basin with swinging spout powered by battery Mitigeur lavabo électronique avec bec rotatif avec alimentation par batteries. Art. 7091SB

LAVABO / BASIN TAP



101free



Rubinetto lavabo elettronico con alimentazione a batteria Electronic basin tap powered by battery Robinet lavabo électronique avec alimentation par batteries. Art. 7035B

LAVABO / BASIN TAP



101free



Rubinetto miscelatore per lavabo, a comando elettronico ed alimentato a batterie. Installazione sopra piano. Connessione tubo flessibile G 1/2"

Codice	Pz	Listino A	Listino B
7091SB	1	390,22 €	433,15 €

Codice	Pz	Listino A	Listino B
7035B	1	253,57 €	281,46 €

Codice	Pz	Listino A	Listino B
703601	1	290,42 €	322,37 €

LAVABO MONOACQUA / BASIN SINGLE WATER TAP



101free



Rubinetto lavabo temporizzato Self-closing basin tap Robinet lavabo temporisé. Art. 9001

LAVABO MISCELATORE / BASIN MIXER



101free



Miscelatore lavabo temporizzato Self-closing basin mixer Mitigeur lavabo temporisé. Art. 9007



Canna Di Erogazione Girevole Completa H 260 L 350 Basetta Di Fissaggio Su Piano. Idral Cod. 09430 Formata Da Art. 09435+09500-350

Codice	Pz	Listino A	Listino B
9001	1	52,72 €	58,52 €

Codice	Pz	Listino A	Listino B
9007	1	87,70 €	97,35 €

Codice	Pz	Listino A	Listino B
BEM350I	1	86,23 €	86,23 €

FLUSSOMETRO INCASSO / BUILT-IN FLUSH VALVE



101free



Flussometro ad incasso studiato per il colpo d'ariete, per installazione a parete G3/4 Concealed wall-mounted flush valve studied for water hammer G3/4 Robinet de chasse encastrable étudié pour le coup de bélier, pour installation mural G3/4. Art. 9455 3/4"

Pre-miscelatore completo di valvola di non ritorno



101free



Pre-miscelatore completo di valvola di non ritorno Pre mixer complete with non-return valve Pre-mitigeur complet avec clapet anti-retour. Art. 9020ECO



Bocca Erogazione Mon. Ec. C/T.

Codice	Pz	Listino A	Listino B
9455G	1	76,97 €	85,43 €

Codice	Pz	Listino A	Listino B
9020ECO	1	25,08 €	27,84 €

Codice	Pz	Listino A	Listino B
BEME1	1	32,57 €	32,57 €
BEME1x5	5	28,95 €	28,95 €



Smart Ingress

Comunità



Bocca Di Erogazione Lavabo Fissa



Idroscopino Att/Muro Idral Cr.



BOCCA PER LAVABO / BASIN SPOUT

Bocca erogazione fusa a parete Wall fused spout
Bec erogation fondu au plancher. . Art. 9013



Codice	Pz	Listino A	Listino B
02026	1	30,94 €	34,34 €
02026x5	5	29,12 €	32,32 €

Codice	Pz	Listino A	Listino B
02420C	1	134,95 €	149,79 €
02420Cx5	5	127,01 €	140,98 €

Codice	Pz	Listino A	Listino B
9013	1	52,04 €	57,77 €
9013x2	2	48,98 €	54,37 €



Maniglione Acciaio Inox 30Cm Lucido



Maniglione Acciaio Inox 45 Cm Lucido



Maniglione Acciaio Inox 60 Cm Lucido



Codice	Pz	Listino A	Listino B
105H08100	1	27,31 €	30,31 €
105H08100x5	5	25,70 €	28,53 €

Codice	Pz	Listino A	Listino B
105H09100	1	28,38 €	31,50 €
105H09100x5	5	26,71 €	29,65 €

Codice	Pz	Listino A	Listino B
105H10100	1	32,13 €	35,66 €
105H10100x5	5	30,24 €	33,57 €



Maniglione Acciaio Bianco 30Cm Bianco



Maniglione Acciaio Bianco 45Cm Bianco



Maniglione Acciaio Bianco 60 Cm Bianco



Codice	Pz	Listino A	Listino B
105H08004	1	18,74 €	20,80 €
105H08004x5	5	17,64 €	19,58 €

Codice	Pz	Listino A	Listino B
105H09004	1	22,22 €	24,67 €
105H09004x5	5	20,92 €	23,22 €

Codice	Pz	Listino A	Listino B
105H10004	1	24,90 €	27,64 €
105H10004x5	5	23,44 €	26,01 €



Dispenser Genius Sanificante



Guarda Video





Maniglione Lineare Cm. 30 Verniciato Bianco Idral



Barra D'Appoggio Ribaltabile 70 Cm Bianco



Codice	Pz	Listino A	Listino B
GNS20NX	1	208,18 €	208,18 €

Codice	Pz	Listino A	Listino B
12000V-30	1	23,94 €	26,57 €
12000V-50	1	31,02 €	34,43 €

Codice	Pz	Listino A	Listino B
101H12004	1	55,44 €	61,54 €
101H12004x2	2	53,40 €	59,27 €



Dispenser Per Sapone A Muro



Dispenser X Sapone A Muro 2 pulsanti D. 21x15x7





Dispenser X Sapone Schiumogeno A Batteria



Codice	Pz	Listino A	Listino B
748665	1	4,96 €	4,96 €
748665x5	5	4,67 €	4,67 €

Codice	Pz	Listino A	Listino B
748666	1	7,72 €	7,72 €
748666x2	2	7,27 €	7,27 €

Codice	Pz	Listino A	Listino B
TX-9730	1	13,86 €	15,38 €





Tubo Doccia 80 X
80 Bianco



110715002

Codice	Pz	Listino A	Listino B
110715002	1	12,10 €	12,10 €



Hk Tenda Doccia
Mod. Hello
180X200Cm

HLK00TD0HLL00

Codice	Pz	Listino A	Listino B
HLK00TD0HLL00	1	8,38 €	8,38 €



Hk Tenda Doccia
Mod. Sweet
180X200Cm

HLK00TD0SWT00

Codice	Pz	Listino A	Listino B
HLK00TD0SWT00	1	8,38 €	8,38 €

Tenda Doccia Strisce 180X180 2 Ass.



100% POLIESTERE
GANCI INCLUSI
180x180cm

Codice	Pz	Listino A	Listino B
645362	1	7,26 €	8,06 €

Tenda Doccia Pallini 180X180 2 Ass.



100% POLIESTERE
GANCI INCLUSI
180x180cm

Codice	Pz	Listino A	Listino B
645363	1	7,66 €	8,50 €

Tenda Doccia 180X180 2 Ass.



100% POLIESTERE
GANCI INCLUSI
180x180cm

Codice	Pz	Listino A	Listino B
645364	1	7,26 €	8,06 €



Rialzo Per Seduta
Wc Bianco



METAFORM®

Codice	Pz	Listino A	Listino B
101R72004	1	34,81 €	38,64 €
101R72004x5	5	32,76 €	36,36 €

Sedile Wc Bianco Sedile For Life



METAFORM®

Codice	Pz	Listino A	Listino B
101E77004	1	32,13 €	35,66 €
101E77004x5	5	30,24 €	33,57 €

Sedile Wc Airbag
Toilet Seat Airbag - Abattant Wc Airbag





METAFORM®

Codice	Pz	Listino A	Listino B
101B44004	1	20,88 €	23,18 €
101B44004x5	5	19,66 €	21,82 €



Sedile Wc Bianco
Aretusa Fit



METAFORM®

Codice	Pz	Listino A	Listino B
101F59004	1	32,13 €	35,66 €
101F59004x5	5	30,24 €	33,57 €



Sedile Wc Fit-
Series Sintesi 2.0



METAFORM®

Codice	Pz	Listino A	Listino B
101F98004	1	32,13 €	35,66 €
101F98004x5	5	30,24 €	33,57 €



Sedile Pesante
Universale Bianco
Economico



METAFORM®

Codice	Pz	Listino A	Listino B
SPUBO	1	25,97 €	28,83 €
SPUBOx5	5	24,44 €	27,13 €



SEDILE WC FIT-
SERIES TESI



METAFORM®

Codice	Pz	Listino A	Listino B
101E72004	1	32,13 €	35,66 €
101E72004x5	5	30,24 €	33,57 €



SEDILE WC FIT-
SERIES CONCA



METAFORM®

Codice	Pz	Listino A	Listino B
101E71004	1	32,13 €	35,66 €
101E71004x5	5	30,24 €	33,57 €

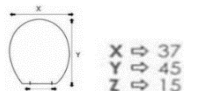
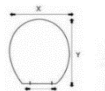

Sedile Wc
Economico Bianco
Rs-3370

METAFORM®

Codice	Pz	Listino A	Listino B
SMEB	1	10,40 €	11,55 €
SMEBx5	5	9,79 €	10,87 €



Sedile Wc Hello Kitty Universale Cerniera In Nylon Regolabile



SWCHKH2501101

Codice	Pz	Listino A	Listino B
SWCHKH2501101	1	12,76 €	12,76 €
SWCHKH2501101x15	15	10,84 €	10,84 €

Copriwater Termoindurente Rosso Zz



SHR

X ⇄ 37
Y ⇄ 45
Z ⇄ 15

Codice	Pz	Listino A	Listino B
SHR	1	16,07 €	16,07 €
SHRx5	5	15,12 €	15,12 €

Copriwater Termoindurente Verde Acqua Zz



SHVA

X ⇄ 37
Y ⇄ 45
Z ⇄ 15

Codice	Pz	Listino A	Listino B
SHVA	1	16,07 €	16,07 €
SHVAx5	5	15,12 €	15,12 €

Coppia Cerniere Copriwater Universale Alette 61 Mm 68 Mm Import



Codice	Pz	Listino A	Listino B
DGO-156	1	5,99 €	6,64 €

Coppia Cerniere Copriwater Universale Alette 54 Mm 57 Mm Import



Codice	Pz	Listino A	Listino B
DGO-157	1	5,99 €	6,64 €

Supporto Sedile Pesante Universale Cromato



Codice	Pz	Listino A	Listino B
SSP	1	5,62 €	6,24 €



Kit Cerniere Pesante cromato. Completo:
1) Vite serraggio parte superiore 2) Kit Accessori montaggio
3) Chiave serraggio cavallotti

Codice	Pz	Listino A	Listino B
KSSU	1	9,24 €	10,25 €
KSSU10	10	8,69 €	9,65 €



Kit Cerniere Pesante cromato. Completo:
1) Vite serraggio parte superiore:
2) Kit Accessori montaggio
3) Viti montaggio sedile

Codice	Pz	Listino A	Listino B
KSSUC	1	7,36 €	8,17 €
KSSUC10	10	6,93 €	7,69 €

Supporto Sedile Sovrapposta



Codice	Pz	Listino A	Listino B
SSS	1	12,05 €	13,37 €
SSS10	10	11,34 €	12,59 €

Supporto Sedile Pesante Un. Barra



Codice	Pz	Listino A	Listino B
SSPU	1	9,64 €	10,70 €
SSPU5	5	9,07 €	10,07 €

Supporto Sedile Espansione



Codice	Pz	Listino A	Listino B
SSE	1	14,73 €	16,35 €
SSE10	10	13,86 €	15,38 €

Kit Cerniera ricambio in Acciaio Inox



Codice	Pz	Listino A	Listino B
52880	1	8,03 €	8,92 €
5288010	10	7,56 €	8,39 €

Supporto X Sedile Viti Zincati



Codice	Pz	Listino A	Listino B
SSMVZ	1	0,81 €	0,90 €
SSMVZ25	25	0,77 €	0,85 €

Supporto Moplen Pvc



Codice	Pz	Listino A	Listino B
SSM	1	0,59 €	0,65 €
SSM25	25	0,56 €	0,62 €

Set Paracolpi Sedili Termoid.



Codice	Pz	Listino A	Listino B
SATSP	1	1,45 €	1,60 €
SATSP25	25	1,36 €	1,51 €

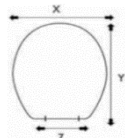

Sat 1 Copriwater
Termoindurente

X ⇒ 39
Y ⇒ 45,5
Z ⇒ 15

Prezzo Unitario

Codice	Riferimenti	Listino A	Listino B	Conf.	Box
SAT1	Bianco	19,15 €	19,15 €	1	5

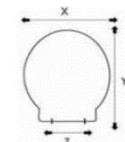

Sat 2 Copriwater
Termoindurente

X ⇒ 37,5
Y ⇒ 42,5
Z ⇒ 18

Prezzo Unitario

Codice	Riferimenti	Listino A	Listino B	Conf.	Box
SAT2	Bianco	37,11 €	41,19 €	1	5

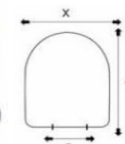

Sat 3 Copriwater
Termoindurente

X ⇒ 37
Y ⇒ 45,5
Z ⇒ 18

Prezzo Unitario

Codice	Riferimenti	Listino A	Listino B	Conf.	Box
SAT3	Bianco	37,11 €	41,19 €	1	5

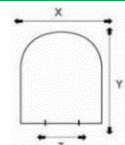

Sat 4 Copriwater
Termoindurente

X ⇒ 37
Y ⇒ 45
Z ⇒ 18

Prezzo Unitario

Codice	Riferimenti	Listino A	Listino B	Conf.	Box
SAT4	Bianco	37,11 €	41,19 €	1	5

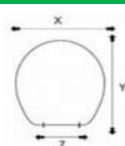

Sat 5 Copriwater
Termoindurente

X ⇒ 39
Y ⇒ 45,5
Z ⇒ 15

Prezzo Unitario

Codice	Riferimenti	Listino A	Listino B	Conf.	Box
SAT5	Bianco	37,11 €	41,19 €	1	5

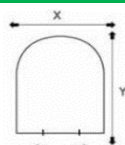

Sat 6 Copriwater
Termoindurente

X ⇒ 35
Y ⇒ 44,5
Z ⇒ 18

Prezzo Unitario

Codice	Riferimenti	Listino A	Listino B	Conf.	Box
SAT6	Bianco	37,11 €	41,19 €	1	5

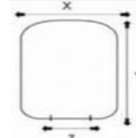

Sat 7 Copriwater
Termoindurente

X ⇒ 35,5
Y ⇒ 45,5
Z ⇒ 16,5

Prezzo Unitario

Codice	Riferimenti	Listino A	Listino B	Conf.	Box
SAT7	Bianco	56,26 €	62,45 €	1	5

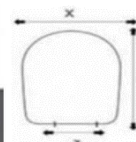

Sat 8 Copriwater
Termoindurente

X ⇒ 35,5
Y ⇒ 45,5
Z ⇒ 17,5

Prezzo Unitario

Codice	Riferimenti	Listino A	Listino B	Conf.	Box
SAT8	Bianco	58,65 €	65,10 €	1	5



Sedile Soft Close Satsu
Universaleuniversal Slim
Adattabilità serie Fast
Azzurra

Prezzo Unitario

Codice	Riferimenti	Listino A	Listino B	Conf.	Box
SATSU	Bianco	35,91 €	39,86 €	1	5

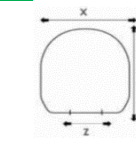

Sat 9 Sedile
Termoindurente

X ⇒ 35,5
Y ⇒ 39,5
Z ⇒ 16

Prezzo Unitario

Codice	Riferimenti	Listino A	Listino B	Conf.	Box
SAT9	Bianco	72,11 €	80,04 €	1	5

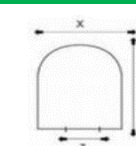
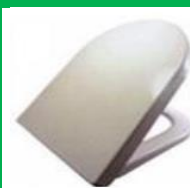

Sedile Soft Close Sat10

X ⇒ 36
Y ⇒ 45,5
Z ⇒ 17

Prezzo Unitario

Codice	Riferimenti	Listino A	Listino B	Conf.	Box
SAT10	Bianco	72,11 €	80,04 €	1	5

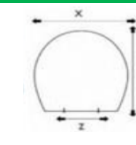

Sedile Soft Close Sat11
Catalano Luce

X ⇒ 36,5
Y ⇒ 44
Z ⇒ 14,5

Prezzo Unitario

Codice	Riferimenti	Listino A	Listino B	Conf.	Box
SAT11	Bianco	58,65 €	65,10 €	1	5

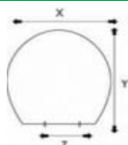

Sedile Soft Close Sat12 Full 48

Prezzo Unitario



X ⇒ 37
Y ⇒ 45
Z ⇒ 18

Codice	Riferimenti	Listino A	Listino B	Conf.	Box
SAT12	Bianco	65,36 €	72,55 €	1	5

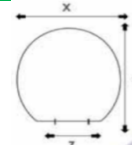

Sedile Soft Close Sat 18

Prezzo Unitario



X ⇒ 36,5
Y ⇒ 40
Z ⇒ 13

Codice	Riferimenti	Listino A	Listino B	Conf.	Box
SAT18	Bianco	72,11 €	80,04 €	1	5

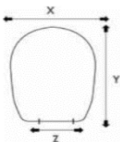

Sedile Soft Close Sat13 Aretusa

Prezzo Unitario



X ⇒ 36
Y ⇒ 47,5
Z ⇒ 14

Codice	Riferimenti	Listino A	Listino B	Conf.	Box
SAT13	Bianco	65,36 €	72,55 €	1	5

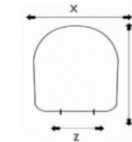

Sedile Soft Close Sat 19

Prezzo Unitario



X ⇒ 35,2
Y ⇒ 46
Z ⇒ 18

Codice	Riferimenti	Listino A	Listino B	Conf.	Box
SAT19	Bianco	69,43 €	77,06 €	1	5

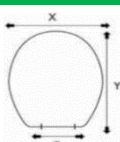

Sedile Soft Close Sat14 Universale

Prezzo Unitario



X ⇒ 37,5
Y ⇒ 44
Z ⇒ 14

Codice	Riferimenti	Listino A	Listino B	Conf.	Box
SAT14	Bianco	67,03 €	74,41 €	1	5

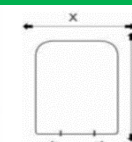

Sedile Soft Close Sat 20

Prezzo Unitario



X ⇒ 36
Y ⇒ 48,5
Z ⇒ 18

Codice	Riferimenti	Listino A	Listino B	Conf.	Box
SAT20	Bianco	72,11 €	80,04 €	1	5

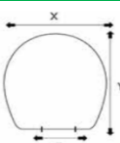

Sedile Soft Close Sat 15 Pozzi ginori colibri

Prezzo Unitario



X ⇒ 37
Y ⇒ 44
Z ⇒ 14

Codice	Riferimenti	Listino A	Listino B	Conf.	Box
SAT15	Bianco	59,85 €	66,43 €	1	5

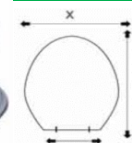

Sedile Soft Close Sat 21

Prezzo Unitario



X ⇒ 36,5
Y ⇒ 46,5
Z ⇒ 14

Codice	Riferimenti	Listino A	Listino B	Conf.	Box
SAT21	Bianco	72,11 €	80,04 €	1	5

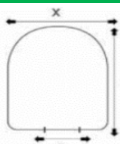

Sedile Soft Close Sat16 Sintesi

Prezzo Unitario



X ⇒ 36,5
Y ⇒ 45,5
Z ⇒ 17

Codice	Riferimenti	Listino A	Listino B	Conf.	Box
SAT16	Bianco	69,43 €	77,06 €	1	5

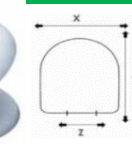

Sedile Soft Close Sat 22

Prezzo Unitario



X ⇒ 37
Y ⇒ 44
Z ⇒ 14

Codice	Riferimenti	Listino A	Listino B	Conf.	Box
SAT22	Bianco	72,11 €	80,04 €	1	5

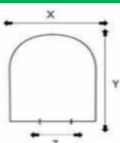

Sedile Soft Close Sat17 Axa One

Prezzo Unitario



X ⇒ 36
Y ⇒ 42
Z ⇒ 17,5

Codice	Riferimenti	Listino A	Listino B	Conf.	Box
SAT17	Bianco	69,43 €	77,06 €	1	5

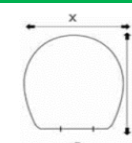

Sedile Termoidurente Per Disabile Soft Close

Prezzo Unitario



X ⇒ 37
Y ⇒ 44
Z ⇒ 14

Codice	Riferimenti	Listino A	Listino B	Conf.	Box
SAT23	Bianco	72,11 €	80,04 €	1	5

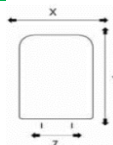

Sedile Termoidurente
Soft Close SAT 24



X ⇨ 35
Y ⇨ 43
Z ⇨ 19

Codice	Riferimenti	Listino A	Listino B	Conf.	Box
SAT24	Bianco	54,94 €	60,99 €	1	5

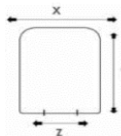

Sedile Termoidurente
Soft Close SAT 25



X ⇨ 35
Y ⇨ 43
Z ⇨ 19

Codice	Riferimenti	Listino A	Listino B	Conf.	Box
SAT25	Bianco	54,94 €	60,99 €	1	5

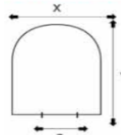

Sedile Termoidurente
Soft Close SAT 26



X ⇨ 36
Y ⇨ 45,5
Z ⇨ 17

Codice	Riferimenti	Listino A	Listino B	Conf.	Box
SAT26	Bianco	54,94 €	60,99 €	1	5

	Kit Cerniera Odeon horizont OD	
	Kit Cerniera Odeon Espansione ED	
	Kit Cerniera Zero Ø	
	Kit Cerniera Expa Plast EP	
	Kit Cerniera Revival R	
	Kit Cerniera Expo E	
	Kit Cerniera Plastica P	
	Kit Cerniera Goccia G	
	Set Paracolpi per sintesi	
	Set Paracolpi	

Codice	Riferimenti	Listino A	Listino B	Conf.	Box
SATCP	Kit Cerniere In Plastica	8,38 €	9,30 €	1	5
SATCZ	Kit Cerniera Zero	14,36 €	15,94 €	1	5
SATCE	Kit Cerniera Expo	17,96 €	19,93 €	1	5
SATCR	Kit Cerniera Revival	14,36 €	15,94 €	1	5
SATCH	Kit Cerniera Horizont	16,76 €	18,60 €	1	5



Ricerca Per Azienda e Modello			Ricerca Per Azienda e Modello			Ricerca Per Azienda e Modello		
Casa	Serie	Sat	Casa	Serie	Sat	Casa	Serie	Sat
Althea	Centro slow close	11	Azzurra	Jubileaeum	2	Cesame	Fenice	21
	Fly slow close	11		Midas	6-19		Mid	2
	Hola	5-14		Mini Nuvola Quadrato	17		Sintesi -	6-19
	Hola Sospeso	5		Mini Nuvola Tondo	9	Cielo	Ares Astra	6
	Marion	3-16		Nuvola	6-10		Celia	6-19
	Ring	6-19	Azzurra	Pratica	6-19		Easybath	2-12
	Sky	1		New Light	19		Ermes -	1
	Smart	4-10	Catalano	C 52	4-10		Easy/Evo	2-12
Astra	Gemma	6-19		C 54	4-10	Cielo	Euro	11
Axa	Axa One slow close	17		Canova	22	Cielo	Florence	3-16
	Axa 2	4-10		Luce	14		Lara	1-11
	Cilvia Cilvia Sospeso	6-19		Neve	3		Medea	3-16
Azzurra	Afrodite	6-19		Neve Sfera	3-16	Cielo	Mithos	2
	Diana	6-13		Sistema C 52	4-10		Smile	4-10
	Elios - Elios Plus	6-19	Cesabo	Elte	1-14	Delta	Trevi	2
	Frine	6		Eridurance	6-19	Disegno Ceramica	Giulia	6-19
	Ful 48	2-12		Exel	1-11		Paolina	2
	Full 54	12		Kris	4-10	Dolomite	Alpina	19
	Full 56	5-14	Cesame	Aretusa Aretusa MB	3-13			
	Giove	1		Aretusina	6-19			
	Giunone	2		Belle Epoque	22			



Ricerca Per Azienda e Modello			Ricerca Per Azienda e Modello			Ricerca Per Azienda e Modello		
Casa	Serie	Sat	Casa	Serie	Sat	Casa	Serie	Sat
	Clodia	3-16	Hatria	Daytime			Oxa	6-19
	Petra	16		Dolce Vita	4		Fly	1-14
	Quadrarco	19		Erika			Letizia	6-19
	Tenax	15		Marylin			Serena	1-14
	Suite	25	Hidra	Pluvia		Pozzi Ginori	Colibri - Colibri 2	
Duravit	Happy D	4-10		Roma	1		Kim	1
Eos	Astra	3-16		Smarty	12		Linea	6
	Clio	6-19		Top Line	16		Monte Bianco	2
	Mistral	6-19		Pegaso	16		Novecento	
	Punto / Punto Sospeso	3-16	House	Prima	5		Panda	
Esedra	Esè - Mix	6-19	Ideal Standard	Conca	7		Quinta	5
	Poing	12		Esedra			Seinova 3	3-19
	Bull	6-19		Fiorile			Ydra	3-16
Etruria	Alba	3		Tesi	8		Fantasia 2	
Faleri	Adria - Adria Sospeso	3-13	Incea	Hide	11	Rak	Orient	8
	Duelta . F30	9		Joe	15		S 50	
	Fish	5-14		Laura			Metropolitan	
	Foglia	6-19		Nube			Compac1	3-13
	Magica	5-14		Opi			Moon	4-10
Flaminia	Fidia	16		Piuma		Roca	Giralda	3
	Link	4-10		Supra	15		Polo	
	Metro Metro MB	3-16	Jumbo	Aretona	13		Polo Sopeso	6-19
	Mini Link	17		Ego	9		Tipo	
	Pompei	1		Tua			Victoria	
	Relax	6-19	Kerasan	Europa	1		Debba	
G.S.I	Clizia	5-14		Flo	4	Sanisuda	Alta	3-16
	Essenza	5-11		Flo 48	17		Aveiro	6-19
	Havant	3-16		Flo 52	10		City	4-10
	Traccia	25		Godia		Scala	Gemma	
	Xenia	6-19		Volant	2	Scic	Donna	
	City	11	Laufen	Dino		Senesi	Pienza	6
	Pura	4-10		Harmony	3		Donatello	
Galassia	Agorà	6-19	Nero Ceramica	Aliseo	20	Simas	Arcade	
	Aster	3-16		Classic	3		Eline	4-10
	Ethos	2		Genesi			Europa	3-16
	Ola	1-14		Iceberg	11		Flow	2
	M2 55	6		Yesterday	5		Londra	2
	M2 45/55	9-19		Skil	15	Vavid	Orientale	3
	Piuma	19		Round				
Globo	Alia	3-16	Olympia	Federica		Veliero	Colombo	3-16
	Arianna	1-14		Impero	2		Colombo 2	6-19
	Bonsai	12		Merkur			Odissea	6-19
	Flavia	3-16		Nicole			Tirreno	3-16
	Grace	6-19		Rubino			Valentina	3
	Lei	5-14		Serie 92		Vitra	S20	
Globo	Misura	3-16		Vela	3		Zentrum	
	Open Space	4-10	Opera Sanitari	Area	24	Vitruvit	Armonia	3-16
	Pestum	2		Aida			Young	6-19
Globo	Bowl	6-19		Venere	26			
Gravenia	Derby	1		Narcisia				
	Garbo - Garbo MB	3		Zero				
	Giada	6-19		Saly				
	Jenny	1-14		Onda				
Hatria	Cannes	1		Young				



Sifone Moplen 2 V. 11/2" Magnum Tutto 11/2"



Codice	Pz	Listino A	Listino B
S2V11\2M	11/2"	4,89 €	5,43 €

Sifone Moplen 1 V. 11/2" Magnum Tutto 11/2"



Codice	Pz	Listino A	Listino B
S1V11\2M	11/2"	3,51 €	3,90 €

Sifone Lavello Autopulente A 1 Via 11/2" S/Piletta



Codice	Pz	Listino A	Listino B
SI1V11\2	11/2"	8,68 €	9,63 €

Sifone 2 Vie 11/4" S /Pilette



Codice	Pz	Listino A	Listino B
S2V11\4	11/4"	2,86 €	3,17 €

Sifone 2 Vie 11/4" Con Pilette



Codice	Pz	Listino A	Listino B
S2V11\4C	11/4"	9,22 €	10,24 €

Sifone Industriale 2 Vie 11/2"



Codice	Pz	Listino A	Listino B
SI2V11\2	11/2"	12,50 €	13,87 €

Sifone 1 Via Moplen Da 11/4" Con Piletta



Codice	Pz	Listino A	Listino B
S1V11\4C	11/4"	4,71 €	5,23 €

Piletta Gattinara 11/4" Ottone



Codice	Pz	Listino A	Listino B
PG11\4	11/4"	7,94 €	8,81 €

Piletta Ø70 Uscita Laterale Tappo Manigl. Ø52 + Tubo Comp



Codice	Pz	Listino A	Listino B
D502E	70	2,97 €	3,30 €

Piletta Gattinara 11/2" Tropp. Man. G. 18/8 D. 70 + Gr.



Codice	Pz	Listino A	Listino B
PGM11\2T	Retto.	6,29 €	6,98 €
PGM11\2TT	Tondo	5,80 €	6,43 €

Piletta Gattinara Moplen 11/2" Tappo E Catena



Codice	Pz	Listino A	Listino B
PGM11\2	11/2"	3,28 €	3,64 €

Raccordo Retto 11/4"X40 Arag.



Codice	Pz	Listino A	Listino B
RR11\4X40A	11/4"	3,67 €	4,08 €

Piletta Canestro 90 C/TP Tondo



Codice	Pz	Listino A	Listino B
PGMG11\2TT	11/2"	13,58 €	15,08 €
PGMG11\2TR	11/2"	13,58 €	15,08 €

Piletta Moplen Gigante 11/2"-90



Codice	Pz	Listino A	Listino B
PGMG11\2	11/2"	10,03 €	11,13 €

Piletta Ø114 Modello Classic Brillante, Tp Rotondo Rigido



Codice	Pz	Listino A	Listino B
D577-36E	Retto.	8,00 €	8,88 €
D590E	Tondo	6,46 €	7,17 €



Smart Ingress

Sifoni & Pilette



Piletta Ø65 Modello Click Clack, Sifone Autopul. Ø32 + Eccentrico Ø32XØ40



Codice	Pz	Listino A	Listino B
SLI004-33E	11/2"	22,39 €	24,85 €

Piletta Ø65 Modello Orion, Sifone Autopul. Ø32 + Eccentrico Ø32XØ40



Codice	Pz	Listino A	Listino B
SOR004-33E	11/2"	15,83 €	17,57 €

Piletta Doccia Plastica Bianca C/Tappo Cromato Est 90X60 Foro



Codice	Pz	Listino A	Listino B
PDSP90HD40	90	5,42 €	6,02 €
PDSP120HD40	120	8,33 €	9,25 €

Sifone Per Vasca Da Bagno Orientabile Con Uscita G1½



Codice	Pz	Listino A	Listino B
DS9000651E	11/2"	1,86 €	2,06 €

Piletta Doccia Splash 11/2" P80



Codice	Pz	Listino A	Listino B
PDM11\2S	11/2"	15,36 €	17,05 €

Piletta Doccia Sc.Fil.D40 D.120 Cr.



Codice	Pz	Listino A	Listino B
5290AB12S7	120	14,81 €	16,44 €

Piletta sifonata per piatto doccia senza piattello - parte superiore piana



Codice	D.	Listino A	Listino B
7005PC120	120	12,97 €	14,39 €
7005PC90	90	4,81 €	5,34 €

Piletta Doccia Turboflow 90 Bianco

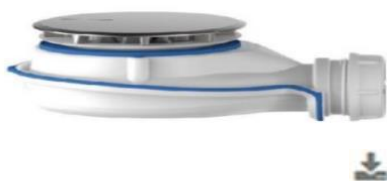

Codice	Pz	Listino A	Listino B
TBFLOXS	1	47,91 €	53,18 €

Piletta Doccia Da 11/4" Sifoide



Codice	Pz	Listino A	Listino B
PD11\4	11/4"	9,07 €	10,07 €

Riduzione Bianca F/M 11/4X1"



Codice	Pz	Listino A	Listino B
PRMHBH	11/4x1	0,27 €	0,30 €
PRMHDHB	11/2x11/4	0,27 €	0,30 €

Riduzione Bianca F/M 11/4X11/2"



Codice	Pz	Listino A	Listino B
ARMHBHD	1	0,27 €	0,30 €

Piletta Doccia Pozzetto Pes.



Codice	Pz	Listino A	Listino B
PDP11\4	11/4"	16,38 €	18,18 €

Cestello Inox X Level. Pil Baskzz



Codice	Pz	Listino A	Listino B
CLBI	1	5,31 €	5,90 €

Griglietta Per Lavelli Inox



Codice	Pz	Listino A	Listino B
GLI	1	0,55 €	0,61 €

Filtro per Lavello D. 11,3



Codice	Pz	Listino A	Listino B
79537	1	2,02 €	2,24 €





Cestello Scattino D.80 Inox



Codice	Pz	Listino A	Listino B
SCATTINO	1	3,72 €	4,13 €



Tappo Saltarello Copripiletta Da 1"1/4

Codice	Pz	Listino A	Listino B
TP114CP	11/4"	4,54 €	5,03 €



Tappo Piletta 1" Pesanti

Codice	Pz	Listino A	Listino B
TPNOCH	1"	3,78 €	4,20 €
TPNOCHB	11/4"	4,06 €	4,51 €

Tap Grill Il Nuovo Tappo A Griglia Raccogli Rifiuti



Codice	Pz	Listino A	Listino B
TAPGRILL	1	3,35 €	3,72 €



Tappo Saltarello Vasca Universale

Codice	Pz	Listino A	Listino B
TPSVU	1	5,04 €	5,59 €



Tappo Piletta Norton 1" Pvc

Codice	Pz	Listino A	Listino B
TPN1	1"	1,89 €	2,10 €
TPN11/4	11/4"	1,89 €	2,10 €



Sifone Arredo Tondo Da 1"1/4

Codice	Pz	Listino A	Listino B
SIFT	11/4"	28,91 €	32,09 €



Cestello Univ.X Pil.Autom 11/4

Codice	Pz	Listino A	Listino B
NSHB00	11/4"	6,17 €	6,85 €



Pilettona Pila 11/4"

Codice	Pz	Listino A	Listino B
PP11/4	1	17,20 €	19,09 €



Sifone Arredo Quadro Da 1"1/4

Codice	Pz	Listino A	Listino B
SIFQZ	11/4"	39,56 €	43,92 €



Tappo Lavandino Universale Pop Pap

Codice	Pz	Listino A	Listino B
87250	Cromo	6,07 €	6,74 €



Colonna Scarico Vasca 11/2"

Codice	Pz	Listino A	Listino B
CVA00	Cromo	44,10 €	48,95 €
CVAC00	Clk Clak	49,61 €	55,07 €



Piletta Click Clack Universale Quadrata Zz

Codice	Pz	Listino A	Listino B
PCUQ	11/4"	23,81 €	26,43 €



Piletta Click Clack Universale D. 1"1/4

Codice	Pz	Listino A	Listino B
PCU	11/4"	18,52 €	20,56 €



Colonna Vasca Automatica d. 11/2"

Codice	Pz	Listino A	Listino B
CVA04	Bianca	38,10 €	42,29 €
CVA47	Bronzo	58,06 €	64,45 €





Sifone A Esse 1"



Codice	Pz	Listino A	Listino B
SE1	1"	15,61 €	17,33 €
SE11\4	11/4"	15,82 €	17,56 €

Sifone A Bottiglia 1"



Codice	Pz	Listino A	Listino B
SB1	1"	14,95 €	16,59 €
SB11\4	11/4"	17,20 €	19,09 €



Kit Asta Per Saltarello

Codice	Pz	Listino A	Listino B
TPAST00000	1	1,67 €	1,86 €

Piletta Norton Tappo Leggero Da 1"



Codice	Pz	Listino A	Listino B
PNEH	1	6,30 €	6,99 €
PNEHB	2	7,01 €	7,78 €

Piletta Da 1" Pesante



Codice	Pz	Listino A	Listino B
PNLH	1	12,45 €	13,82 €
PNLHB	2	12,45 €	13,82 €

Asta Piletta Norton Zz



Codice	Pz	Listino A	Listino B
APN	1	1,38 €	1,53 €



Gomito Per Sifone Mf 11/2 Con Ghiera Senza Guarnizione

Codice	Pz	Listino A	Listino B
1357CUR00	11/2"	0,55 €	0,61 €



Kit Scarico Universale Con Doppio Tubo Flessibile

Codice	Pz	Listino A	Listino B
260246DU00	11/2"	2,99 €	3,32 €

Estensibile Con Ghiera Plastica universale d, 1" - 11/4" 11/2"x32/40 + 3 guarnizioni

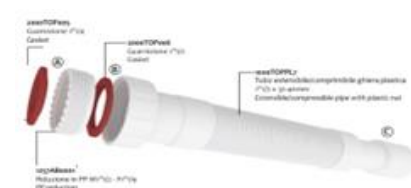

Codice	Pz	Listino A	Listino B
SFLEXPUN	1	2,22 €	2,46 €



Estensibile Ghiera Metallo D. 11/2"x40

Codice	Pz	Listino A	Listino B
SFLEXH32	1X32	1,51 €	1,67 €
SFLEXHB32	11/4X32	1,58 €	1,75 €
SFLEXHD40	11/2X40	1,58 €	1,75 €



Raccordo Rapido Crom. 11/2"x40

Codice	Pz	Listino A	Listino B
SFLEXDH32	1X32	2,84 €	3,16 €
SFLEXDHB32	11/4X32	2,84 €	3,16 €
SFLEXDHD40	11/2X40	2,84 €	3,16 €
SFLEXDHD4050	11/2X4050	2,84 €	3,16 €



Estensibile 11/4"x32 Bonomini

Codice	Pz	Listino A	Listino B
E1X26B	1X26	Arrivo	Arrivo
E1X32B	11/4X32	Arrivo	Arrivo
E11\4X32B	11/4X32	Arrivo	Arrivo
E11\2X40B	11/2X40	Arrivo	Arrivo



Estensibile Spiralato Anima In Acciaio D. 11/2"x32 D40

Codice	Pz	Listino A	Listino B
SFLEXCH26	1X26	5,91 €	6,56 €
SFLEXCH32	1X32	5,91 €	6,56 €
SFLEXCHB32	11/4X32	5,91 €	6,56 €
SFLEXCHD32	11/2X32	5,91 €	6,56 €
SFLEXCHB40	11/4X40	5,91 €	6,56 €
SFLEXCHD40	11/2X40	5,91 €	6,56 €



Giunto Pp Bianco Con 2 Ghiere

Codice	Pz	Listino A	Listino B
6004PL2632	26X32	4,69 €	5,21 €
6004PL0032	32X32	4,29 €	4,76 €
6004PL3240	32X40	4,69 €	5,21 €
6004PL0040	40X40	4,69 €	5,21 €
6004PL0026	26X26	4,29 €	4,76 €



Raccordo Piombo Pvc

Codice	Pz	Listino A	Listino B
RPP32	11/4X32	6,06 €	6,73 €
RPP40	11/2X40	6,06 €	6,73 €



Art. 300 Canotto in ottone cromato

Codice	Riferimenti	Listino A	Listino B	Off.	Pz
30026X25	26x25 mm	3,25 €	3,61 €	1	10
30026X30	26x30 mm	3,79 €	4,20 €	1	10
30030X25	30x25 mm	3,79 €	4,20 €	1	10
30030X30	30x30 mm	4,40 €	4,88 €	1	10
30032X25	32x25 mm	4,00 €	4,44 €	1	10
30032X30	32x30 mm	4,65 €	5,16 €	1	10
30040X25	40x25 mm	3,05 €	3,39 €	1	10
30040X30	40x30 mm	3,47 €	3,85 €	1	10
30026X100	26x100 mm	5,99 €	6,65 €	1	10
30030X100	30x100 mm	14,02 €	15,56 €	1	10
30032X100	32x100 mm	15,49 €	17,19 €	1	10
30040X100	40x100 mm	11,07 €	12,29 €	1	10



Art. 301 Canotto con battuta in ottone cromato

Codice	Riferimenti	Listino A	Listino B	Off.	Pz
30126X25	26x25 mm	3,29 €	3,65 €	1	10
30126X30	26x30 mm	3,83 €	4,25 €	1	10
30130X25	30x25 mm	2,42 €	2,69 €	1	10
30130X30	30x30 mm	4,48 €	4,97 €	1	10
30132X25	32x25 mm	4,05 €	4,49 €	1	10
30132X30	32x30 mm	4,69 €	5,21 €	1	10
30140X25	40x25 mm	3,23 €	3,58 €	1	10
30140X30	40x30 mm	8,95 €	9,94 €	1	10



Art. 303 Canotto flessibile in rame cromato

Codice	Riferimenti	Listino A	Listino B	Off.	Pz
30326X25	26x25 cm	6,58 €	7,30 €	1	10
30326X30	26x30 cm	7,13 €	7,92 €	1	10
30330X25	30x25 cm	2,99 €	3,32 €	1	10
30330X30	30x30 cm	7,79 €	8,65 €	1	10
30332X25	32x25 cm	6,88 €	7,64 €	1	10
30332X30	32x30 cm	7,99 €	8,87 €	1	10



Art. 305 Canotto 45° per cassette alta con tubo incassato

Codice	Riferimenti	Listino A	Listino B	Off.	Pz
305C30x24	30X240	4,79 €	5,31 €	1	10
305C30x28	30X280	5,44 €	6,04 €	1	10
305C30X32	30X320	6,20 €	6,88 €	1	10



Rosone per canotto D. esterno D. 75

Codice	Riferimenti	Listino A	Listino B	Off.	Pz
R2600	D. 26 cromo	0,49 €	0,54 €	1	10
R3000	D. 30 cromo	0,48 €	0,54 €	1	10
R3200	D. 32 cromo	0,47 €	0,52 €	1	10
R4000	D. 40 cromo	0,83 €	0,92 €	1	10
R3047	D. 30 Bronzo	8,43 €	9,35 €	1	10
R3247	D. 32 Bronzo	8,43 €	9,35 €	1	10



Rosone per canotto D. esterno D. 75 L77XH14

Codice	Riferimenti	Listino A	Listino B	Off.	Pz
ROC00	Cromo	1,02 €	1,13 €	1	10
ROC47	Bronzo	0,92 €	1,02 €	1	10
ROC65	Rame	0,92 €	1,02 €	1	10



PIASTRA PASSO RAPIDO TONDA OTTONE

Codice	Riferimenti	Listino A	Listino B	Off.	Pz
2911P25	25 mm	4,54 €	5,03 €	1	10
2911P28	28 mm	4,49 €	4,98 €	1	10



Cestello Inox X Lavel.Pil Bask

Import Export

Codice	Pz	Listino A	Listino B
01508		1,52 €	1,69 €



feltro Isavello 7,5 cm. pz. 2

Import Export

Codice	Pz	Listino A	Listino B
10398		1,39 €	1,54 €



Tappo Copriforo Pesante Cromozz

Codice	Pz	Listino A	Listino B
TCP00		1,53 €	1,70 €



Coudix Manicotto Flessibile D. 40

Codice	Pz	Listino A	Listino B
COU4052		21,61 €	23,98 €



Manicotto Flessibile 40 Mf

Codice	Pz	Listino A	Listino B
FLEXBNI		9,11 €	10,11 €



Connessione Estensibile Per Wc Go-Magic-Lux 290/590 Mm C/Curva

Codice	Pz	Listino A	Listino B
1024ELBOW1		11,13 €	12,36 €



	Rosetta Larga Da 1/2" Cm. 7 Ottone Cromato		Rosetta Inox Foro Esagonale		Chiusino Ot. Cromo Vert. Faris						
Codice	Pz	Listino A	Listino B	Codice	Pz	Listino A	Listino B	Codice	Pz	Listino A	Listino B
RL1\2	50	0,50 €	0,55 €	2906ID	50	0,23 €	0,25 €	917	11/4"	21,67 €	24,06 €
	Rosetta Biella 1/2" Cromo		Rosone Acciao Inox 1/2"		Chiusino Laterale Ottone Cr.						
Codice	Pz	Listino A	Listino B	Codice	Pz	Listino A	Listino B	Codice	Pz	Listino A	Listino B
R1\200	100	0,43 €	0,48 €	2900ID	100	0,23 €	0,25 €	CCCR	cromo	4,47 €	4,96 €
	Curvetta 1/2"X10 Cromo Esag.		Rubinetto Squadra 1/2" F - 1/2" M C-Codulo 3/8" M		Piletta per Fontane a cestello finitura ottone lucido D. 1"						
Codice	Pz	Listino A	Listino B	Codice	Pz	Listino A	Listino B	Codice	Pz	Listino A	Listino B
C1\2X10E	1	Arrivo	Arrivo	RSCWCD	1	7,09 €	7,87 €	PFCH	1"	12,95 €	14,38 €
C1\2X10EX20	X20	Arrivo	Arrivo	RSCWCDX5	X5	6,71 €	7,45 €	PFCHB	11/4"	13,46 €	14,94 €
C1\2X10EX50	X50	Arrivo	Arrivo	RSCWCDX10	X10	6,38 €	7,08 €				
C1\2X10EX100	X100	Arrivo	Arrivo	RSCWCDX15	X15	6,04 €	6,71 €				
	Rub. Filtro Snodo 1/2"X10		Rubinetto Filtro 1/2"X10 Vitone		Piletta per Fontane finitura bronzato D. 1"						
Codice	Pz	Listino A	Listino B	Codice	Pz	Listino A	Listino B	Codice	Pz	Listino A	Listino B
RF1\2X10	1	7,42 €	8,24 €	RF1\2X10V	1	6,71 €	7,45 €	PFH47	1"	14,27 €	15,84 €
RF1\2X10X10	X10	7,03 €	7,80 €	RF1\2X10VX10	X10	6,36 €	7,06 €	PFHB47	11/4"	15,18 €	16,85 €
RF1\2X10X20	X20	6,68 €	7,41 €	RF1\2X10VX20	X20	6,04 €	6,70 €				
RF1\2X10X50	X50	6,33 €	7,02 €	RF1\2X10VX50	X50	5,72 €	6,35 €				
	Set Fissaggio Mix C. 40 2 Bul.		Set Fissaggio Mix C. 40 1 Bul.		Kit Rubinetto Sq.1/2"X10 Bronzo						
Codice	Pz	Listino A	Listino B	Codice	Pz	Listino A	Listino B	Codice	Pz	Listino A	Listino B
HY-228A	1	1,94 €	2,15 €	HY-228	1	1,67 €	1,85 €	KCRDC47	1	34,90 €	38,74 €
	Riduzione 1/2m22X1 Ott Cromato		Riduzione 3/4xm22X1 Ott Cromato "Xx"		Riduzione M22X1 3/4 Ott Cromato						
Codice	Pz	Listino A	Listino B	Codice	Pz	Listino A	Listino B	Codice	Pz	Listino A	Listino B
1350092094	1	3,65 €	4,05 €	1350092594	1	1,47 €	1,63 €	1350050894	1	7,22 €	8,02 €



Riduzione M22X1 X M24X1 Ottone Nichelato



Riduzione 3/4Mxm24X1 Ott Cromato "Xx"



Riduzione In Ottone Cromata 24/1Mx1/2"M "Xx"

Codice	Pz	Listino A	Listino B	Codice	Pz	Listino A	Listino B	Codice	Pz	Listino A	Listino B
1350050394	1	7,13 €	7,92 €	1350051094	1	2,07 €	2,29 €	140/R1	1	1,39 €	1,54 €



Antivibrante 1/2"X25 Cm. Mf



Antivibrante 3/4"X30 Cm. Mf

Codice	Riferimenti	Listino A	Listino B	Off.	Pz
A1\2X25	1/2" X25	4,79 €	5,32 €	1	1
A1\2X30	1/2" X30	5,08 €	5,64 €	1	1
A1\2X35	1/2" X35	5,37 €	5,96 €	1	1
A1\2X40	1/2" X40	5,69 €	6,31 €	1	1
A1\2X50	1/2" X50	6,30 €	6,99 €	1	1

Codice	Riferimenti	Listino A	Listino B	Off.	Pz
A3\4X25	3/4" X25	5,66 €	6,29 €	1	1
A3\4X30	3/4" X30	7,62 €	8,46 €	1	1
A3\4X35	3/4" X35	6,24 €	6,93 €	1	1
A3\4X40	3/4" X40	8,57 €	9,52 €	1	1
A3\4X40	3/4" X50	8,57 €	9,52 €	1	1



Antivibrante 1"X30 Cm.



Antivibrante 1 1/4"X30 Cm.

Codice	Riferimenti	Listino A	Listino B	Off.	Pz
A1X25	1" X25	8,57 €	9,52 €	1	1
A1X30	1" X30	11,38 €	12,63 €	1	1
A1X35	1" X35	9,31 €	10,34 €	1	1
A1X40	1" X40	11,62 €	12,90 €	1	1
A1X50	1" X50	13,39 €	14,86 €	1	1

Codice	Riferimenti	Listino A	Listino B	Off.	Pz
A11\4X25	1 1/4" X25	16,69 €	18,53 €	1	1
A11\4X30	1 1/4" X30	18,42 €	20,45 €	1	1
A11\4X35	1 1/4" X35	17,92 €	19,89 €	1	1
A11\4X40	1 1/4" X40	21,46 €	23,82 €	1	1
A11\4X50	1 1/4" X50	24,55 €	27,25 €	1	1



Flex Inox 1/2" X 30 Cm. Mf



Flex Inox 1/2" X 3/8" 30 Cm. Mf

Codice	Riferimenti	Listino A	Listino B	Off.	Pz
FI25	1/2" X25	3,09 €	3,43 €	1	1
FI30	1/2" X30	2,06 €	2,29 €	1	1
FI35	1/2" X35	2,93 €	3,25 €	1	1
FI40	1/2" X40	3,07 €	3,41 €	1	1
FI50	1/2" X50	2,33 €	2,58 €	1	1

Codice	Riferimenti	Listino A	Listino B	Off.	Pz
FI3\8X25	1/2x3/8x25	2,64 €	2,93 €	1	1
FI3\8X30	1/2x3/8x30	2,12 €	2,35 €	1	1
FI3\8X35	1/2x3/8x35	2,93 €	3,25 €	1	1
FI3\8X40	1/2x3/8x40	3,07 €	3,41 €	1	1
FI3\8X50	1/2x3/8x50	2,65 €	2,94 €	1	1

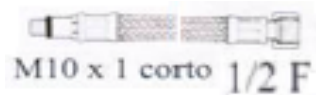

Flex X Mix Inox 1/4X1/2"Fx25

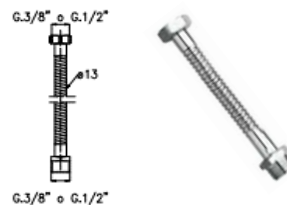

Flex Rame 1/2" Mx1/2" F X 30 Cm.

Codice	Riferimenti	Listino A	Listino B	Off.	Pz
FM25	U. 1/2" F CM. 25	2,76 €	3,07 €	1	1
FM30	U. 1/2" F CM. 30	2,88 €	3,19 €	5	1
FM35	U. 1/2" F CM. 35	2,30 €	2,56 €	10	1

Codice	Riferimenti	Listino A	Listino B	Off.	Pz
FR25	1/2" X25	2,83 €	3,14 €	1	1
FR30	1/2" X30	2,94 €	3,27 €	1	1
FR35	1/2" X35	3,07 €	3,40 €	1	1
FR40	1/2" X40	3,72 €	4,13 €	1	1
FR50	1/2" X50	3,85 €	4,27 €	1	1



Aeratore Prolungato 22X1F Bianco

Codice	Pz	Listino A	Listino B
APFB	1	1,99 €	2,21 €



Aeratore Prolungato 22X1F Cromo

Codice	Pz	Listino A	Listino B
APFCR	1	3,97 €	4,41 €



Aeratore Prolungato 22X1F con 2 getti Cromo

Codice	Pz	Listino A	Listino B
APFCRCR	1	5,60 €	6,21 €



Doccia A Mano Doccetta Portatile Per Lavandino Tubo Anticalcare Campeggio 8827

Codice	Pz	Listino A	Listino B
8827	1	15,12 €	16,78 €



ROmpigetto perLavello Risparmio acqua adattabile 22 femmina 24 maschio

Codice	Pz	Listino A	Listino B
69269	1	2,02 €	2,24 €



ROmpigetto perLavello Risparmio acqua adattabile 22 femmina 24 maschio

Codice	Pz	Listino A	Listino B
69265	1	1,89 €	2,10 €



ROmpigetto perLavello Risparmio acqua bloccabile nella canna erogazione

Codice	Pz	Listino A	Listino B
69264	1	1,89 €	2,10 €

Rompigetto per lavello Risparmio Acqua



Codice	Pz	Listino A	Listino B
69274	1	3,78 €	4,20 €

Guarnizione per Aeratore M24 pz 12



Codice	Pz	Listino A	Listino B
69382	1	1,51 €	1,68 €



Rompigetto Rubinetto, Aeratore Rubinetto, Aeratori per Rubinetti, per la Sostituzione Della Testa del Rubinetto Della Cucina, 3 Impostazioni Attacco Femmina D, 22



Codice	Pz	Listino A	Listino B
LM98734	1	16,38 €	18,18 €



Snodo Con Aeratore Per Bidet Vedi Anche Il Codice Aerocsf22

Codice	Pz	Listino A	Listino B
ASBF	1	3,81 €	4,23 €



Aeratore Maschio Snodo Bidetz

Codice	Pz	Listino A	Listino B
ASBM	1	2,82 €	3,13 €

Aeratore Af22 Ottone Cr F 22 Xx Vedi Anche Il Codice Af22 "Xx"



Codice	Pz	Listino A	Listino B
AEREXF22	1	0,38 €	0,42 €

Aeratore Cromo M. 24X1



Codice	Pz	Listino A	Listino B
AEREXM24	24	0,46 €	0,51 €
AEREXM22	22	0,30 €	0,34 €

Aeratore Am28 Cromo M.28X1 Vedia Nche Il Codice Am28



Codice	Pz	Listino A	Listino B
AEREXM28	1	0,70 €	0,77 €



Sif.Inc.Lav B. Uscita 11/2"X40



Codice	Pz	Listino A	Listino B
SILPEHHD40	Bianco	2,54 €	2,82 €
SILPEHIHD40	Inox	2,42 €	2,68 €

Sif.Inc.Lav Phed Bianco+Uscita 40 Liscia



Codice	Pz	Listino A	Listino B
SILPEHB40	Bianco	2,67 €	2,97 €
SILPEHI40	Inox	2,67 €	2,97 €

Sifone Esterno X Lav Bianco



Codice	Pz	Listino A	Listino B
SELB	Bianco	2,02 €	2,24 €
SELC	Cromo	3,19 €	3,54 €

Racc.Diritto Tubo Sc.Lav 19X22



Codice	Pz	Listino A	Listino B
RDTS1922	1	0,14 €	0,15 €
RDTS1919	1	0,26 €	0,28 €

Canotto Con Cartella 1"1/2 X 40 Con Due Attacchi Lavatrice



Codice	Pz	Listino A	Listino B
1006AT2LAV	1	1,67 €	1,85 €

Raccordo Doppio Per Due Lavatrici O Lavatrice/Asciugatrice Attacco 1"



Codice	Pz	Listino A	Listino B
1268POLL00	1	9,32 €	10,35 €

Attacco Lavatrice 11/4" X32 B.



Codice	Pz	Listino A	Listino B
AL11\4	11/4"	1,83 €	2,03 €
AL11\2	11/2"	2,31 €	2,56 €

Curvetta Scarico Lavatrice In Ottone Con Attacco Asciugatrice E Tappo Supplementare



Codice	Pz	Listino A	Listino B
DCLCATA	1	13,11 €	14,56 €

Raccordo Doppio Per Due Lavatrici O Lavatrice/Asciugatrice Attacco Liscio Ø32



Codice	Pz	Listino A	Listino B
1268USCI32	1	8,82 €	9,79 €

Tubo Car. Lav.Con Curvacm.150 Ex Tc150C



Codice	Pz	Listino A	Listino B
TPCLC150	150	3,60 €	4,00 €
TPCLC200	200	3,02 €	3,36 €

Curva Abs X Lavatrice Bianco 1" Fx22 Vedi Articolo Rplbh

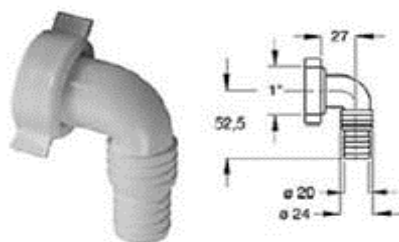

Codice	Pz	Listino A	Listino B
CSL1	1	1,09 €	1,21 €

Raccordo "Y" Sc. Lavatrice Pvc



Codice	Pz	Listino A	Listino B
RYSL	1	0,47 €	0,52 €

Tubo Carico Lavatrice Ff Senza Curva 150 Cm. Ex Tc150



Codice	Pz	Listino A	Listino B
TPCL150	150	3,60 €	4,00 €
TPCL200	200	4,11 €	4,56 €

Tubo Sca.Wash Fless Lav 60A200 Tsl200E



Codice	Pz	Listino A	Listino B
TESLL200	2 Mt.	2,37 €	2,63 €
TESLL300	3 Mt.	2,82 €	3,13 €

Racc.Dop.Nylon Lav 3/4X3/4X3/4



Codice	Pz	Listino A	Listino B
RCLDNFMM	1	1,46 €	1,62 €



Tubo Wc Bianco Con Rosone



Codice	Pz	Listino A	Listino B
TWC100X255	1	6,45 €	7,16 €

Morsetto Retto Wc Da 110Zz



Codice	Pz	Listino A	Listino B
MRWC	1	1,96 €	1,96 €
MRWCx5	5	Arrivo	Arrivo

Morsetto Eccentrico Wc



Codice	Pz	Listino A	Listino B
MEWC	1	1,75 €	1,75 €
MEWCx5	5	Arrivo	Arrivo

Morsetto Gomma B. Wc 50X30Zz



Codice	Pz	Listino A	Listino B
MWC50X30	1	0,29 €	0,32 €

Mors. Maggiorato X Wc M. 55X30



Codice	Pz	Listino A	Listino B
MWC55X30	1	0,57 €	0,64 €

Morsetto Gomma lianca per Wc D. 60X30



Codice	Pz	Listino A	Listino B
MWC60X30	1	0,45 €	0,50 €

Mors.X Scarico Condens. M.34X14



Codice	Pz	Listino A	Listino B
MSC34X14	50	0,84 €	0,94 €

Mors.Gomma B. X Sifoni M.76X40

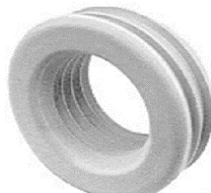

Codice	Pz	Listino A	Listino B
MWC76X40	50	1,44 €	1,60 €

Mors. In Gomma X Vaso 60X40/44



Codice	Pz	Listino A	Listino B
MWC60X40/44	50	0,50 €	0,56 €

Morsetto Interno D. 32x 25/26



Codice	Pz	Listino A	Listino B
MI32X25/26	50	0,33 €	0,36 €

Morsetto In Gomma interno D. 40X26/32



Codice	Pz	Listino A	Listino B
MI40X26/32	50	0,33 €	0,36 €

Mors. Gomma Sotto Vaso 46X40



Codice	Pz	Listino A	Listino B
MI46X40	50	0,18 €	0,20 €

Mors.Gomma Sotto Vaso 50X26/32



Codice	Pz	Listino A	Listino B
MI50X26/32	50	0,34 €	0,37 €

Morsetto Int. 50X40



Codice	Pz	Listino A	Listino B
MI50X40	50	0,27 €	0,30 €

Morsetto In Gomma M. 32X25/26



Codice	Pz	Listino A	Listino B
ME32X25/26	32	0,32 €	0,36 €
ME40X25/26	40	0,65 €	0,72 €



Guarnizione Esente Mm.2 3/4"
Zx Preo Pz. 1

Codice	Riferimenti	Listino A	Listino B	Off.	Pz
2100ESEOC	D. 3/8"	0,02 €	0,02 €	1	100
2100ESEOD	D. 1/2"	0,02 €	0,03 €	1	100
2100ESEOG	D. 3/4"	0,02 €	0,03 €	1	100
2100ESEOH	D. 1"	0,03 €	0,04 €	1	100
2100ESEHB	D. 1 1/4"	0,06 €	0,06 €	1	100
2100ESEHD	D. 1 1/2"	0,07 €	0,07 €	1	100
2100ESEOL	D. 2"	0,38 €	0,43 €	1	50



Benda Vinilica Bianca H.10 25M

Codice	Riferimenti	Listino A	Listino B	Off.	Pz
RBVB	Bianco	4,13 €	4,59 €	1	10
RBVGC	Grigio Chiaro	4,38 €	4,87 €	1	10
RBVBLU	Blu	4,38 €	4,87 €	1	10
RBVR	Rosso	4,38 €	4,87 €	1	10



Guarnizione in gomma Bordo
Leggero Mm 2,3 D.3/4

Codice	Riferimenti	Listino A	Listino B	Off.	Pz
GSP1/2	D. 1/2"	0,24 €	0,27 €	1	50
GSP3/4	D. 3/4"	0,35 €	0,39 €	1	50
GSP1	D. 1"	0,31 €	0,34 €	1	50
GSP11/4	D. 1 1/4"	0,40 €	0,44 €	1	50
GSP11/2	D. 1 1/2"	0,34 €	0,38 €	1	50



Guarnizione Conica Bianca
D.3/4

Codice	Riferimenti	Listino A	Listino B	Off.	Pz
GCP1/2	D. 1/2"	0,16 €	0,18 €	1	50
GCP3/4	D. 3/4"	0,28 €	0,31 €	1	50
GCP1	D. 1"	0,36 €	0,40 €	1	50
GCP11/4	D. 1 1/4"	0,46 €	0,51 €	1	50
GCP11/2	D. 1 1/2"	0,37 €	0,41 €	1	50



Rotolo Loctite
Mt.150 Rot.



Tappo
Provampian. Blu
Da 1/2"



Rotolo Nastro X
Gas 12X12X0,10Zz

Codice	Pz	Listino A	Listino B	Codice	Pz	Listino A	Listino B	Codice	Pz	Listino A	Listino B
L55	1	19,17 €	21,28 €	TPIBD	Blu	0,25 €	0,28 €	RTGAS01	1	0,30 €	0,34 €
				TPIRD	Rosso	0,25 €	0,28 €				



Guarnizione per
Radiatore 2 Mm. 1"

Stearina In Pani Kg.
1



Verga In Lega
Stagno 33% Kg. 1



Rotolo Nastro X
Gas 19X15X0,20 Xz

Codice	Pz	Listino A	Listino B	Codice	Pz	Listino A	Listino B	Codice	Pz	Listino A	Listino B
1094RAE20H	1"	0,05 €	0,06 €	STCS01	1	4,48 €	4,97 €	RTGAS02	1	1,20 €	1,33 €
1094RAE2HB	1 1/4"	0,06 €	0,07 €	STST33	2	7,92 €	8,79 €				



Canapa Pettinata
Prezzo A Matassina
Piccola Ogni 16
Matassine
Corrispondono 1 Kg.



Pasta Siliconica X
Filetti



Pasta Verde Giun.
Fil. Sicurverde 460
Gr

Codice	Pz	Listino A	Listino B	Codice	Pz	Listino A	Listino B	Codice	Pz	Listino A	Listino B
CPM	1	1,58 €	1,75 €	PVS	1	6,89 €	7,65 €	PV	1	3,05 €	3,38 €



Cassetta Zaino Beta Plus

Scheda
Tecnica



Codice	Riferimenti	Listino A	Listino B	Off.	Pz
CZPB		34,21 €	37,97 €	1	5
CZPBx5	Offertax5	32,41 €	35,97 €	5	5
CZPBx10	Offertax10	30,79 €	34,17 €	10	5
CZPBx15	Offertax15	27,15 €	30,14 €	15	5



Cassetta Plus Doppio Scar. B

Scheda
Tecnica



Codice	Riferimenti	Listino A	Listino B	Off.	Pz
CZP2B		48,03 €	53,31 €	1	5
CZP2Bx5	Offertax5	45,50 €	50,51 €	5	5
CZP2Bx10	Offertax10	43,23 €	47,98 €	10	5
CZP2Bx15	Offertax15	38,12 €	42,32 €	15	5



Cassetta A Zaino Delta Elegant
Silenziata Con Polisterolo Bianca

Scheda
Tecnica



Codice	Riferimenti	Listino A	Listino B	Off.	Pz
CZDB		34,90 €	38,74 €	1	5
CZDBx5	Offertax5	33,07 €	36,70 €	5	5
CZDBx10	Offertax10	31,41 €	34,87 €	10	5
CZDBx15	Offertax15	27,71 €	30,75 €	15	5



Cassetta A Zaino Beta S/Rub

Scheda
Tecnica



Codice	Riferimenti	Listino A	Listino B	Off.	Pz
CZBB		34,52 €	38,32 €	1	5
CZBBx5	Offertax5	32,70 €	36,30 €	5	5
CZBBx10	Offertax10	31,07 €	34,49 €	10	5
CZBBx15	Offertax15	27,40 €	30,42 €	15	5



Cassetta A Zaino Delta 2
Pulsanti Silenziata Bianca

Scheda
Tecnica



Codice	Riferimenti	Listino A	Listino B	Off.	Pz
CZ2DB		49,01 €	54,40 €	1	5
CZ2DBx5	Offertax5	46,43 €	51,53 €	5	5
CZ2DBx10	Offertax10	44,11 €	48,96 €	10	5
CZ2DBx15	Offertax15	38,90 €	43,18 €	15	5



Cassetta Cr Sfera 1Riv.S/Rub

Scheda
Tecnica



Codice	Riferimenti	Listino A	Listino B	Off.	Pz
1000S1		47,47 €	52,69 €	1	5
1000S1x5	Offertax5	44,97 €	49,92 €	5	5
1000S1x10	Offertax10	42,72 €	47,42 €	10	5
1000S1x15	Offertax15	37,68 €	41,83 €	15	5



Cassetta Alta Completa Cat.

Scheda
Tecnica



Codice	Riferimenti	Listino A	Listino B	Off.	Pz
CAC		30,46 €	33,81 €	1	5
CACx5	Offertax5	28,86 €	32,03 €	5	5
CACx10	Offertax10	27,42 €	30,43 €	10	5
CACx15	Offertax15	24,18 €	26,84 €	15	5



Cassetta Wc A Zaino Con Tubo
Water Saving Concept 1
pulsanter

Scheda
Tecnica



Codice	Riferimenti	Listino A	Listino B	Off.	Pz
1000C1		52,36 €	58,12 €	1	5
1000C1x5	Offertax5	49,60 €	55,06 €	5	5
1000C1x10	Offertax10	47,12 €	52,30 €	10	5
1000C1x15	Offertax15	41,56 €	46,13 €	15	5



Wc Galleggiante Magnetic
Esterne-Incasso

Scheda
Tecnica



Codice	Riferimenti	Listino A	Listino B	Off.	Pz
CMAGNCER		21,38 €	23,73 €	1	5



Galleggiante Blu Rambo 3/8"

Scheda
Tecnica



Codice	Riferimenti	Listino A	Listino B	Off.	Pz
GCZBR		8,70 €	9,66 €	1	5
GCZBRx5	Offertax5	8,27 €	9,18 €	5	5
GCZBRx10	Offertax10	7,83 €	8,69 €	10	5
GCZBRx15	Offertax15	7,74 €	8,59 €	15	5



 <p>Pull Bianca C/Catenella Cm. 70</p>	 <p>60 cm Tubo Cassetta A Zaino Plus B.Zx</p> <p>TUBO A ZAINO Ø50x32 Tubi di scarico</p>	 <p>Tubo Cassetta A Zaino D. 100X50</p>																																
<table border="1"> <thead> <tr> <th>Codice</th> <th>Pz</th> <th>Listino A</th> <th>Listino B</th> </tr> </thead> <tbody> <tr> <td>PECB70</td> <td>1</td> <td>1,40 €</td> <td>1,55 €</td> </tr> </tbody> </table>	Codice	Pz	Listino A	Listino B	PECB70	1	1,40 €	1,55 €	<table border="1"> <thead> <tr> <th>Codice</th> <th>Pz</th> <th>Listino A</th> <th>Listino B</th> </tr> </thead> <tbody> <tr> <td>TCZ60</td> <td>1</td> <td>7,33 €</td> <td>8,14 €</td> </tr> </tbody> </table>	Codice	Pz	Listino A	Listino B	TCZ60	1	7,33 €	8,14 €	<table border="1"> <thead> <tr> <th>Codice</th> <th>Pz</th> <th>Listino A</th> <th>Listino B</th> </tr> </thead> <tbody> <tr> <td>TCZ100</td> <td>1</td> <td>9,91 €</td> <td>10,99 €</td> </tr> </tbody> </table>	Codice	Pz	Listino A	Listino B	TCZ100	1	9,91 €	10,99 €								
Codice	Pz	Listino A	Listino B																															
PECB70	1	1,40 €	1,55 €																															
Codice	Pz	Listino A	Listino B																															
TCZ60	1	7,33 €	8,14 €																															
Codice	Pz	Listino A	Listino B																															
TCZ100	1	9,91 €	10,99 €																															
 <p>Guarnizione Meccanismo Cassetta Cr 1540</p> 	 <p>Meccanismo Cassetta Alta Alfa</p>	 <p>Gruppo Sollevamento Pneu</p>																																
<table border="1"> <thead> <tr> <th>Codice</th> <th>Pz</th> <th>Listino A</th> <th>Listino B</th> </tr> </thead> <tbody> <tr> <td>GMCZ</td> <td>1</td> <td>1,71 €</td> <td>1,89 €</td> </tr> <tr> <td>GMCZx20</td> <td>20</td> <td>1,54 €</td> <td>1,70 €</td> </tr> </tbody> </table>	Codice	Pz	Listino A	Listino B	GMCZ	1	1,71 €	1,89 €	GMCZx20	20	1,54 €	1,70 €	<table border="1"> <thead> <tr> <th>Codice</th> <th>Pz</th> <th>Listino A</th> <th>Listino B</th> </tr> </thead> <tbody> <tr> <td>1401A</td> <td>1</td> <td>12,12 €</td> <td>13,45 €</td> </tr> </tbody> </table>	Codice	Pz	Listino A	Listino B	1401A	1	12,12 €	13,45 €	<table border="1"> <thead> <tr> <th>Codice</th> <th>Pz</th> <th>Listino A</th> <th>Listino B</th> </tr> </thead> <tbody> <tr> <td>GSC</td> <td>1</td> <td>19,52 €</td> <td>21,66 €</td> </tr> </tbody> </table>	Codice	Pz	Listino A	Listino B	GSC	1	19,52 €	21,66 €				
Codice	Pz	Listino A	Listino B																															
GMCZ	1	1,71 €	1,89 €																															
GMCZx20	20	1,54 €	1,70 €																															
Codice	Pz	Listino A	Listino B																															
1401A	1	12,12 €	13,45 €																															
Codice	Pz	Listino A	Listino B																															
GSC	1	19,52 €	21,66 €																															
<p>Tubo Cassetta 2 Pei Usc. 45</p>  <p>Art. 1505</p>  <p>Scheda Tecnica</p>	<p>Tubo Cassetta Alta Esterno Art. 1500A</p>  <p>TCAE Scheda Tecnica Art. 1500C TCAI Scheda Tecnica</p>  	<p>Pulsante Sollevamento Pneu Cr</p>  <p>PI Scheda Tecnica PIC Scheda Tecnica</p>  																																
<table border="1"> <thead> <tr> <th>Codice</th> <th>Pz</th> <th>Listino A</th> <th>Listino B</th> </tr> </thead> <tbody> <tr> <td>TCCA45</td> <td>1</td> <td>6,73 €</td> <td>7,47 €</td> </tr> </tbody> </table>	Codice	Pz	Listino A	Listino B	TCCA45	1	6,73 €	7,47 €	<table border="1"> <thead> <tr> <th>Codice</th> <th>Pz</th> <th>Listino A</th> <th>Listino B</th> </tr> </thead> <tbody> <tr> <td>TCAE</td> <td>Est.</td> <td>9,70 €</td> <td>10,76 €</td> </tr> <tr> <td>TCAI</td> <td>Int.</td> <td>9,70 €</td> <td>10,76 €</td> </tr> </tbody> </table>	Codice	Pz	Listino A	Listino B	TCAE	Est.	9,70 €	10,76 €	TCAI	Int.	9,70 €	10,76 €	<table border="1"> <thead> <tr> <th>Codice</th> <th>Pz</th> <th>Listino A</th> <th>Listino B</th> </tr> </thead> <tbody> <tr> <td>PI</td> <td>Bianco</td> <td>24,90 €</td> <td>27,64 €</td> </tr> <tr> <td>PIC</td> <td>Cromo</td> <td>50,34 €</td> <td>55,88 €</td> </tr> </tbody> </table>	Codice	Pz	Listino A	Listino B	PI	Bianco	24,90 €	27,64 €	PIC	Cromo	50,34 €	55,88 €
Codice	Pz	Listino A	Listino B																															
TCCA45	1	6,73 €	7,47 €																															
Codice	Pz	Listino A	Listino B																															
TCAE	Est.	9,70 €	10,76 €																															
TCAI	Int.	9,70 €	10,76 €																															
Codice	Pz	Listino A	Listino B																															
PI	Bianco	24,90 €	27,64 €																															
PIC	Cromo	50,34 €	55,88 €																															
 <p>Pedale Sollevamento Pneu Cr</p>  <p>Scheda Tecnica</p>	 <p>Pedale Sollevamento Pneu Cr.</p>  <p>Scheda Tecnica</p>	<p>Pulsante Sollevamento Pneu Cr</p>  <p>Scheda Tecnica Scheda Tecnica</p>  																																
<table border="1"> <thead> <tr> <th>Codice</th> <th>Pz</th> <th>Listino A</th> <th>Listino B</th> </tr> </thead> <tbody> <tr> <td>PPI</td> <td>1</td> <td>58,49 €</td> <td>64,93 €</td> </tr> </tbody> </table>	Codice	Pz	Listino A	Listino B	PPI	1	58,49 €	64,93 €	<table border="1"> <thead> <tr> <th>Codice</th> <th>Pz</th> <th>Listino A</th> <th>Listino B</th> </tr> </thead> <tbody> <tr> <td>PPE</td> <td>1</td> <td>72,69 €</td> <td>80,68 €</td> </tr> </tbody> </table>	Codice	Pz	Listino A	Listino B	PPE	1	72,69 €	80,68 €	<table border="1"> <thead> <tr> <th>Codice</th> <th>Pz</th> <th>Listino A</th> <th>Listino B</th> </tr> </thead> <tbody> <tr> <td>PE</td> <td>Bianco</td> <td>34,07 €</td> <td>37,82 €</td> </tr> <tr> <td>PEC</td> <td>Cromo</td> <td>50,34 €</td> <td>55,88 €</td> </tr> </tbody> </table>	Codice	Pz	Listino A	Listino B	PE	Bianco	34,07 €	37,82 €	PEC	Cromo	50,34 €	55,88 €				
Codice	Pz	Listino A	Listino B																															
PPI	1	58,49 €	64,93 €																															
Codice	Pz	Listino A	Listino B																															
PPE	1	72,69 €	80,68 €																															
Codice	Pz	Listino A	Listino B																															
PE	Bianco	34,07 €	37,82 €																															
PEC	Cromo	50,34 €	55,88 €																															
 <p>Cassetta Incasso Fusion Per Muratura E Vaso A Pavimento</p>	<p>Placca Bianca A 2 Tasti X Cassetta Fusion Cr</p> 	<p>Placca Cromataa 2 Tasti X Cassetta Fusion Cr</p> 																																
<table border="1"> <thead> <tr> <th>Codice</th> <th>Pz</th> <th>Listino A</th> <th>Listino B</th> </tr> </thead> <tbody> <tr> <td>1060F</td> <td>1</td> <td>98,36 €</td> <td>109,18 €</td> </tr> </tbody> </table>	Codice	Pz	Listino A	Listino B	1060F	1	98,36 €	109,18 €	<table border="1"> <thead> <tr> <th>Codice</th> <th>Pz</th> <th>Listino A</th> <th>Listino B</th> </tr> </thead> <tbody> <tr> <td>1061B2</td> <td>1</td> <td>15,45 €</td> <td>17,15 €</td> </tr> </tbody> </table>	Codice	Pz	Listino A	Listino B	1061B2	1	15,45 €	17,15 €	<table border="1"> <thead> <tr> <th>Codice</th> <th>Pz</th> <th>Listino A</th> <th>Listino B</th> </tr> </thead> <tbody> <tr> <td>1061C2</td> <td>1</td> <td>36,42 €</td> <td>40,42 €</td> </tr> </tbody> </table>	Codice	Pz	Listino A	Listino B	1061C2	1	36,42 €	40,42 €								
Codice	Pz	Listino A	Listino B																															
1060F	1	98,36 €	109,18 €																															
Codice	Pz	Listino A	Listino B																															
1061B2	1	15,45 €	17,15 €																															
Codice	Pz	Listino A	Listino B																															
1061C2	1	36,42 €	40,42 €																															



Cassette Eco Incasso New
M Con Placca Linea Bianca
P-0560

PUCCI® eco®
DUE PULSANTI DI SCARICO

Codice	Riferimenti	Listino A	Listino B	Off.	Pz
P-CEICAL		163,35 €	163,35 €	1	3
P-CEICALx3	Offertax3	152,46 €	152,46 €	3	3
P-CEICALx6	Offertax6	145,20 €	145,20 €	6	3
P-CEICALx9	Offertax9	134,31 €	134,31 €	9	3



Cassette Eco Incasso New
M Con Placca Linea Cromo
P-0562

PUCCI® eco®
DUE PULSANTI DI SCARICO

Codice	Riferimenti	Listino A	Listino B	Off.	Pz
P-CEICAL		188,10 €	188,10 €	1	3
P-CEICALx3	Offertax3	175,56 €	175,56 €	3	3
P-CEICALx6	Offertax6	167,20 €	167,20 €	6	3
P-CEICALx9	Offertax9	154,66 €	154,66 €	9	3



Cassette Eco Incasso New
M Con Placca Ellisse
Bianca P-0550

PUCCI® eco®
DUE PULSANTI DI SCARICO

Codice	Riferimenti	Listino A	Listino B	Off.	Pz
P-CEICA		163,35 €	163,35 €	1	3
P-CEICAx3	Offertax3	152,46 €	152,46 €	3	3
P-CEICAx6	Offertax6	145,20 €	145,20 €	6	3
P-CEICAx9	Offertax9	134,31 €	134,31 €	9	3



Cassette Eco Incasso New
M Con Placca Ellisse Cromo
P-0552

PUCCI® eco®
DUE PULSANTI DI SCARICO

Codice	Riferimenti	Listino A	Listino B	Off.	Pz
P-CEICAC		188,10 €	188,10 €	1	3
P-CEICACx3	Offertax3	175,56 €	175,56 €	3	3
P-CEICACx6	Offertax6	167,20 €	167,20 €	6	3
P-CEICACx9	Offertax9	154,66 €	154,66 €	9	3



Cassette Pucci Eco Incasso New
M Senza Placca .

PUCCI® eco®
DUE PULSANTI DI SCARICO

Codice	Riferimenti	Listino A	Listino B	Off.	Pz
P-CEISP		149,65 €	149,65 €	1	3
P-CEISPx3	Offertax3	139,67 €	139,67 €	3	3
P-CEISPx6	Offertax6	133,02 €	133,02 €	6	3
P-CEISPx9	Offertax9	123,05 €	123,05 €	9	3

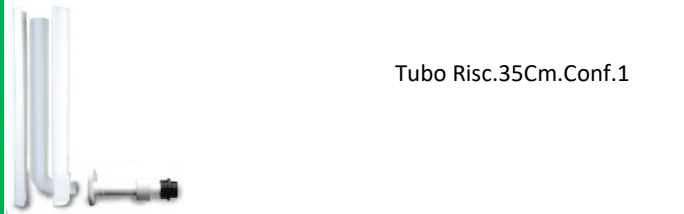

Tubo Risc.35Cm.Conf.1

Codice	Riferimenti	Listino A	Listino B	Off.	Pz
P-6560		20,14 €	20,14 €	1	3
P-6560x5	Offertax5	18,80 €	18,80 €	5	3
P-6560x10	Offertax10	17,90 €	17,90 €	10	3
P-6560x15	Offertax15	16,56 €	16,56 €	15	3

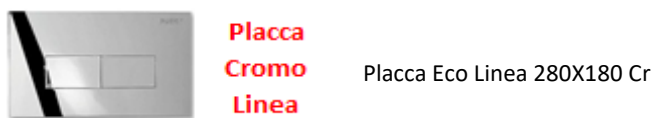

Placca
Cromo
Linea

Placca Eco Linea 280X180 Cr

PROMO

PLACCHE 4,7 mm

Codice	Riferimenti	Listino A	Listino B	Off.	Pz
P-0562		58,07 €	64,46 €	1	3
P-0562x3	Offertax3	54,20 €	60,16 €	3	3
P-0562x6	Offertax6	51,62 €	57,30 €	6	3
P-0562x9	Offertax9	47,75 €	53,00 €	9	3

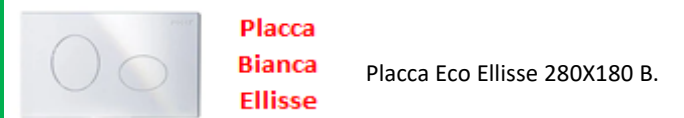

Placca
Bianca
Ellisse

Placca Eco Ellisse 280X180 B.

PROMO

PLACCHE 4,7 mm

Codice	Riferimenti	Listino A	Listino B	Off.	Pz
P-0550		30,44 €	30,44 €	1	3
P-0550x3	Offertax3	28,41 €	28,41 €	3	3
P-0550x6	Offertax6	27,06 €	27,06 €	6	3
P-0550x9	Offertax9	25,03 €	25,03 €	9	3

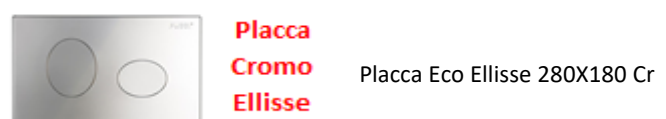

Placca
Cromo
Ellisse

Placca Eco Ellisse 280X180 Cr

PROMO

PLACCHE 4,7 mm

Codice	Riferimenti	Listino A	Listino B	Off.	Pz
P-0552		57,74 €	64,09 €	1	3
P-0552x3	Offertax3	53,89 €	59,82 €	3	3
P-0552x6	Offertax6	51,32 €	56,97 €	6	3
P-0552x9	Offertax9	47,47 €	52,70 €	9	3

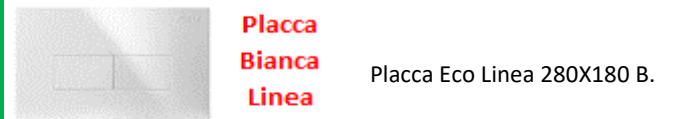

Placca
Bianca
Linea

Placca Eco Linea 280X180 B.

PROMO

PLACCHE 4,7 mm

Codice	Riferimenti	Listino A	Listino B	Off.	Pz
P-0560		30,45 €	30,45 €	1	3
P-0560x3	Offertax3	28,42 €	28,42 €	3	3
P-0560x6	Offertax6	27,07 €	27,07 €	6	3
P-0560x9	Offertax9	25,04 €	25,04 €	9	3



LINEA bianca

Sara Inc. New Model Con
Placca Linea Bianca P-0660

PUCCI® SARA 9

PULSANTE ALTO PER PARETI
IN MURATURA - PER WC

80130660

Codice	Riferimenti	Listino A	Listino B	Off.	Pz
P-CSCA		121,71 €	121,71 €	1	3
P-CSCAx3	Offertax3	113,59 €	113,59 €	3	3
P-CSCAx6	Offertax6	108,18 €	108,18 €	6	3
P-CSCAx9	Offertax9	100,07 €	100,07 €	9	3



Sara Inc. New Model
S/Placca

PUCCI® SARA 9

PULSANTE ALTO PER PARETI
IN MURATURA - PER WC

Codice	Riferimenti	Listino A	Listino B	Off.	Pz
P-CSSP		101,44 €	101,44 €	1	3
P-CSSPx3	Offertax3	94,67 €	94,67 €	3	3
P-CSSPx6	Offertax6	90,17 €	90,17 €	6	3
P-CSSPx9	Offertax9	83,40 €	83,40 €	9	3



Cassetta Incasso Pucci Rame
Senza Placca

Codice	Riferimenti	Listino A	Listino B	Off.	Pz
P-CPSP		196,43 €	196,43 €	1	3
P-CPSPx3	Offertax3	186,09 €	186,09 €	3	3
P-CPSPx6	Offertax6	176,78 €	176,78 €	6	3
P-CPSPx9	Offertax9	167,48 €	167,48 €	9	3



Cassetta Incasso Pucci Rame
Completa Di Placca P-7510
Bianca

Codice	Riferimenti	Listino A	Listino B	Off.	Pz
P-CPCA		217,39 €	217,39 €	1	3
P-CPCAx3	Offertax3	205,94 €	205,94 €	3	3
P-CPCAx6	Offertax6	195,65 €	195,65 €	6	3
P-CPCAx9	Offertax9	185,35 €	185,35 €	9	3



Cassetta Incasso Pucci Rame
Con Placca Cromo P-7512

Codice	Riferimenti	Listino A	Listino B	Off.	Pz
P-CPCAC		241,81 €	241,81 €	1	3
P-CPCACx3	Offertax3	229,08 €	229,08 €	3	3
P-CPCACx6	Offertax6	217,63 €	217,63 €	6	3
P-CPCACx9	Offertax9	206,17 €	206,17 €	9	3



Sara Inc. New Model Con
Placca Linea Cromo P-0662

PUCCI® SARA 9

PULSANTE ALTO PER PARETI
IN MURATURA - PER WC

80130662 cromata

Codice	Riferimenti	Listino A	Listino B	Off.	Pz
P-CSCAC		143,65 €	143,65 €	1	3
P-CSCACx3	Offertax3	134,07 €	134,07 €	3	3
P-CSCACx6	Offertax6	127,69 €	127,69 €	6	3
P-CSCACx9	Offertax9	118,11 €	118,11 €	9	3



Placca Sara Linea Cromo

80130662 cromata

PLACCHE 4,7 mm

Codice	Riferimenti	Listino A	Listino B	Off.	Pz
P-0662		46,54 €	46,54 €	1	3
P-0662x3	Offertax3	43,44 €	43,44 €	3	3
P-0662x6	Offertax6	41,37 €	41,37 €	6	3
P-0662x9	Offertax9	38,27 €	38,27 €	9	3



LINEA bianca
80130660

Placca Sara Linea 280X180 B.

PLACCHE 4,7 mm

Codice	Riferimenti	Listino A	Listino B	Off.	Pz
P-0660		22,35 €	22,35 €	1	3
P-0660x3	Offertax3	20,86 €	20,86 €	3	3
P-0660x6	Offertax6	19,86 €	19,86 €	6	3
P-0660x9	Offertax9	18,38 €	18,38 €	9	3



Placca C /Telaio Ros. Fil. Bot. E
Prol. A 3 Cm. Bianca

Codice	Riferimenti	Listino A	Listino B	Off.	Pz
P-7510		24,24 €	24,24 €	1	3
P-7510x3	Offertax3	22,97 €	22,97 €	3	3
P-7510x6	Offertax6	21,82 €	21,82 €	6	3
P-7510x9	Offertax9	20,67 €	20,67 €	9	3



Placca Pucci C /Telaio Ros. Fil.
Bot. E Prol. A 3 Cm. Cromo 7512
Pz 1

Codice	Riferimenti	Listino A	Listino B	Off.	Pz
P-7512		50,02 €	55,52 €	1	3
P-7512x3	Offertax3	47,38 €	52,60 €	3	3
P-7512x6	Offertax6	45,01 €	49,97 €	6	3
P-7512x9	Offertax9	42,65 €	47,34 €	9	3



Cassetta Doppio Pulsante Senza Placche

Codice	Pz	Listino A	Listino B
P-CPDPSP	1	178,26 €	197,87 €

Placca C/Di Telaio, 2 Ros.Fil. Bott.E Prol. A 3 Cm.Cromo C.1

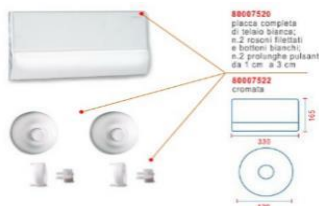

Codice	Pz	Listino A	Listino B
P-7522	1	44,69 €	49,61 €

Placca C / Di Telaio, 2 Ros. Fil. Bott. E Prol. A 3 Cm. B.



Codice	Pz	Listino A	Listino B
P-7520	1	21,56 €	23,93 €



Cassetta New Eco Esterna



Codice	Pz	Listino A	Listino B
P-CEE	1	88,58 €	98,32 €



Pucciplast Sara Tvs Modulo Cassetta Con Telaio Codice Prod: 1323000201



Codice	Pz	Listino A	Listino B
1323490201	1	226,75 €	251,70 €

Galleg.Completo Att.Laterale Conf.1



Codice	Pz	Listino A	Listino B
P-9151	1	28,89 €	32,07 €

Galleggiante Att.Centrale Fino 89 Conf.1



Codice	Off.	Listino A	Listino B
P-9250	1	27,62 €	30,65 €

Galleggiante Pucci Universale



Codice	Off.	Listino A	Listino B
P-9150	1	29,51 €	32,76 €
P-9150x10	10	22,92 €	25,44 €

Galleggiante In Polistirolo



Codice	Off.	Listino A	Listino B
P-9078	1	3,58 €	3,97 €

Valvola Attacco Centrale Conf.1



Codice	Off.	Listino A	Listino B
P-9214	1	14,49 €	16,08 €

Conf. Guarnizione Scodellino Conf. 10 pz Prezzo Pz 1



Codice	Off.	Listino A	Listino B
P-9001	1	0,36 €	0,40 €

Dado Dx/Sx Guarn.3/8" Conf.1



Codice	Off.	Listino A	Listino B
P-9016	1	6,10 €	6,77 €

Pulsante Compl. Pvc 3 Cm.



Codice	Off.	Listino A	Listino B
P-7540	1	18,42 €	20,45 €

Pulsante Completo Cassetta 6/8 Conf.1



Codice	Off.	Listino A	Listino B
P-9035	1	19,72 €	21,89 €

Pulsante Pucci Univ. Ottone



Codice	Off.	Listino A	Listino B
P-9034	1	35,61 €	39,53 €
P-9034x10	10	27,65 €	30,69 €



Serie Pulsante Conf.1



Guarizione Gomma Sagomata 2,5 Mm Conf. Pz 5 Prezzo Pz. 1



Ghiera Conf. 5 Prezzo Pz. 1



Codice	Off.	Listino A	Listino B
P-9030	1	6,68 €	7,42 €

Codice	Off.	Listino A	Listino B
P-9003	1	0,69 €	0,76 €

Codice	Off.	Listino A	Listino B
P-9024	1	1,35 €	1,50 €

Prolunga Pucci Cm. 1



Prolunga Pulsante Cm.2 Conf.1



Prolunga Pulsante Cm.3 Conf.1

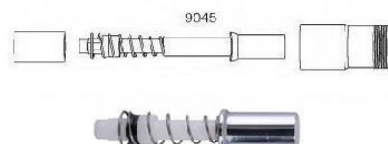

Codice	Off.	Listino A	Listino B
P-9143	1	14,83 €	16,46 €

Codice	Off.	Listino A	Listino B
P-9044	1	15,55 €	17,26 €

Codice	Off.	Listino A	Listino B
P-9045	1	16,30 €	18,09 €

Boccola Cromo Fissa Rosone Pz. 1



Rosone Boccola Cromo Pucci



Sieger Pulsante Pz. 1

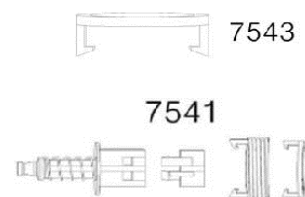

Codice	Pz	Listino A	Listino B
P-9032	1	1,66 €	1,85 €

Codice	Pz	Listino A	Listino B
P-9033	1	8,31 €	9,22 €

Codice	Pz	Listino A	Listino B
P-7543	1	1,37 €	1,52 €

Prolunga Pulsante Da 3Cm A5



80007547
n.1 prolunga da 3 a 5 cm

Pucci Rosone Bottone Bian.7530



Serie Puls.Con Pist.Molla Guarn.A Labro Sieger E Prol.

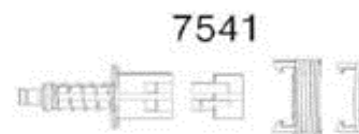

Codice	Off.	Listino A	Listino B
P-7547	1	9,04 €	10,04 €

Codice	Off.	Listino A	Listino B
P-7530	Bianco	7,70 €	8,54 €
P-7532	Cromo	21,84 €	24,25 €

Codice	Off.	Listino A	Listino B
P-7541	1	9,31 €	10,33 €

Serie Guarnizione fondo piu' guarnizione scodellino galleggiante più membrana



Guarnizione Sede Sfera Conf. 10 pz Prezzo sinsolo Pz. 1



Guarda Video Montaggio



Sfera Di Tenuta Conf. 1



Codice	Off.	Listino A	Listino B
KGFTP	1	4,25 €	4,72 €

Codice	Off.	Listino A	Listino B
P-9038	1	2,17 €	2,41 €
P-9038x10	10	1,68 €	1,86 €

Codice	Off.	Listino A	Listino B
P-9039	1	8,12 €	9,02 €



Pistoncino Pz. 1



Codice	Off.	Listino A	Listino B
P-9115	10	1,46 €	1,62 €

Pistoncino Con Guarnizione 10X5 Mm Pz. 1



Guarda Video Montaggio



Codice	Off.	Listino A	Listino B
P-6555	10	1,44 €	1,60 €

Or161 Per Sede Estraibile Pz. 1

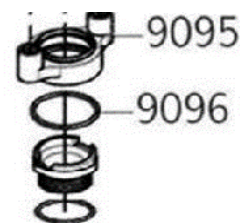

Codice	Off.	Listino A	Listino B
P-9096	10	0,99 €	1,10 €



Leve Per Valvola Conf.5

Codice	Off.	Listino A	Listino B
P-6556	5	4,36 €	4,84 €



Gruppo Sollevamento Con Sfera

Codice	Off.	Listino A	Listino B
P-9970	1	38,75 €	43,01 €



Batteria Completa Con Sfera Conf.1

Codice	Off.	Listino A	Listino B
P-5570	1	35,77 €	39,70 €

Estraibile Con 2Or 147 E Guar. Sede Econf.1



Codice	Off.	Listino A	Listino B
P-6595	1	9,84 €	10,92 €

Gruppo Completo Sfera Con Astina Conf.1



Rame Polietilene 6/8 Prod. fino all'83

Codice	Off.	Listino A	Listino B
P-6261	1	11,97 €	13,29 €

Gruppo Rosone Ecc. Or 143 Can.22 Cm. Bianco Conf.1



Codice	Off.	Listino A	Listino B
P-1390	1	4,27 €	4,74 €

Placca Eco Linea 280X180 Nero



Codice	Off.	Listino A	Listino B
P-0561	1	28,42 €	31,55 €

Pucciplast 9560 Nuova Placca Eco (2 Pulsanti) Cm 33X18 Spessore 12 Mm Con Telaio Porta Placca



Codice	Off.	Listino A	Listino B
P-9560	1	55,90 €	62,05 €

Placca Eco Linea Cromata 280X180Mm 4,7 Mm Spessore + Sportello Eco



Codice	Off.	Listino A	Listino B
P-9562	1	75,71 €	84,04 €

Kit Tubo Risc.56X11 Riv. Completo Bianco Conf.1



80001460

n.1 - tubo di risciacquamento 56x11 cm con rivestimento e tappo regolabile in altezza (+2-2 cm), codulo in plastica, cannotto 22 cm, rosone eccentrico e morsetto combinato Ø48-58 mm con coprimorsetto - bianco

Codice	Off.	Listino A	Listino B
P-1460	1	26,08 €	28,95 €

Placca Sara Linea Bianca 280X180Mm 4,7 Mm Spessore + Sportello



Codice	Off.	Listino A	Listino B
P-9660	1	48,86 €	54,24 €

Placca Sara Linea Cromata 280X180Mm 4,7 Mm Spessore + Sportello



Codice	Off.	Listino A	Listino B
P-9662	1	62,82 €	69,73 €



Rubinetto Ottone Da 1/2" Conf.1



Gruppo Valvola Compl. Conf.1



Gruppo Valvola Completo Conf.1

GALLEGGIANTE PUCCI PER CASSETTA A INCASSO ECO 8000650

Codice	Off.	Listino A	Listino B
P-6544	1	18,37 €	20,39 €

Codice	Off.	Listino A	Listino B
P-5250	1	28,78 €	31,95 €

Codice	Off.	Listino A	Listino B
P-6550	1	28,14 €	31,24 €

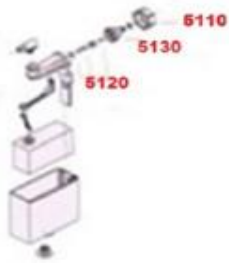

Pistoncino Con Guarn. Pz. 1



Curva 31X19,5Cm. 50-40 Bianca



Batteria Scarico Completa Viva

Codice	Off.	Listino A	Listino B
P-5120	1	1,43 €	1,58 €

Codice	Off.	Listino A	Listino B
P-3320	1	13,85 €	15,38 €

Codice	Off.	Listino A	Listino B
P-3110	1	20,86 €	23,15 €



Guarnizione Fondo In Para Pz.1



Guarnizione Di Fondo Ø 54X26X3 Mm Fino Al '91 Abs Pz. 1



Guarnizione Di Fondo Ø 63X31X3 Mm Nova - Abs Pz. 1

Codice	Off.	Listino A	Listino B
P-3130	10	1,36 €	1,51 €

Codice	Off.	Listino A	Listino B
P-4230	10	0,86 €	0,96 €

Codice	Off.	Listino A	Listino B
P-4231	10	0,86 €	0,96 €

Morsetto Comb.48-58 Bianco



n.1 - morsetto combinato Ø 48-58 mm con coprimorsetto - bianco

80001331 cromato



Gruppo Sollevamento Batteria

Telaio Guida Sfera Pz. 1

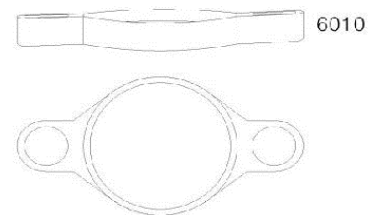

Codice	Off.	Listino A	Listino B
P-1330	Bianco	6,49 €	7,21 €
P-1331	Cromo	7,79 €	8,65 €

Codice	Off.	Listino A	Listino B
P-4970	1	20,63 €	22,90 €

Codice	Off.	Listino A	Listino B
P-6010	1	1,20 €	1,33 €



Rubinetto Gallegian. Att.Basso Da 3/8" Con Sfera T /Ottone



Confezione Sportello Con Inserti M5 conf. 5 pz Prezzo Pz. 1

Gambetti Prolung.10Cm. Dadini & Pastiglie Pz. 1

P-9049

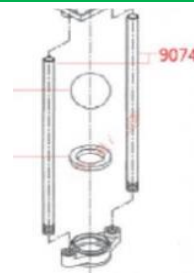

Tubo Silenziatore Per Tutti I Modelli

Codice	Off.	Listino A	Listino B
RGAB3\8C	3/8"	10,00 €	11,10 €
RGAB1\2C	1/2"	10,30 €	11,43 €

Codice	Off.	Listino A	Listino B
P-9076	1	4,45 €	4,94 €
P-9049	1	3,86 €	4,28 €

Codice	Off.	Listino A	Listino B
P-9074	1	2,57 €	2,86 €



Sifone Diba



Codice	Riferimenti	Listino A	Listino B	Off.	Box
BAASP		51,86 €	57,57 €	1	10



Canna Curva 45° 30X240

Codice	Riferimenti	Listino A	Listino B	Off.	Box
305C30x24	30X240	4,79 €	5,31 €	1	10
305C30x28	30X280	5,44 €	6,04 €	1	10
305C30x32	30X280	6,20 €	6,88 €	1	10



Batteria Aria Con Kit

Colori Disponibili



CROMO BRONZO RAME



Codice	Riferimenti	Listino A	Listino B	Off.	Box
BAAC00	Cromo	107,08 €	118,86 €	1	10
BAAC47	Bronzo	185,25 €	205,62 €	1	10
BAAC65	Rame	188,32 €	209,03 €	1	10



Isante Colore Cromo Con Tubo Ra



Codice	Riferimenti	Listino A	Listino B	Off.	Box
300100	Cromo	20,28 €	22,51 €	1	10
300147	Bronzo	20,28 €	22,51 €	1	10
300165	Rame	20,28 €	22,51 €	1	10

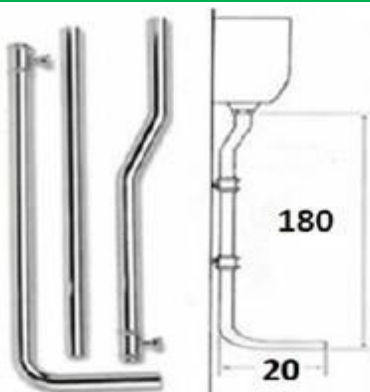

Tubo Esterno Cromo Diba

Colori Disponibili



CROMO BRONZO RAME



Codice	Riferimenti	Listino A	Listino B	Off.	Box
TED00	Cromo	204,98 €	227,53 €	1	10
TED47	Bronzo	219,62 €	243,78 €	1	10
TED65	Rame	223,82 €	248,44 €	1	10



Rosone Catis Dn. 80

Codice	Riferimenti	Listino A	Listino B	Off.	Box
ROC00	Cromo	1,02 €	1,13 €	1	10
ROC47	Bronzo	0,92 €	1,02 €	1	10
ROC65	Rame	0,92 €	1,02 €	1	10



Canna 45°/Rosone Cm.28 CROMO

Codice	Riferimenti	Listino A	Listino B	Off.	Box
CCR3000	Cromo	4,91 €	5,45 €	1	10
CCR3047	Bronzo	20,48 €	22,73 €	1	10
CCR3065	Rame	19,58 €	21,74 €	1	10



Batt. Univ. Comando Pneu. C/Guazz

Codice	Riferimenti	Listino A	Listino B	Off.	Box
2410NT0000		16,39 €	18,20 €	1	10



Wc Valvola Pulsar Dual + Pulsante

Codice	Riferimenti	Listino A	Listino B	Off.	Box
CPULSAR2		84,21 €	93,47 €	1	10



Nuova Cassetta Av1 80Mm



Codice	Riferimenti	Listino A	Listino B	Off.	Box
38863000		148,92 €	165,30 €	1	3
38863000x3	Offertax3	138,99 €	154,28 €	3	3
38863000x6	Offertax6	132,38 €	146,94 €	6	3
38863000x9	Offertax9	122,45 €	135,92 €	9	3



Skate Cosmopolitan Piastra Di Azionamento Cromata



Codice	Riferimenti	Listino A	Listino B	Off.	Box
38732000		82,64 €	91,73 €	1	3
38732000x3	Offertax3	77,13 €	85,62 €	3	3
38732000x6	Offertax6	73,46 €	81,54 €	6	3
38732000x9	Offertax9	67,95 €	75,42 €	9	3



Skate Cosmopolitan Piastra Di Azionamento Bianca



Codice	Riferimenti	Listino A	Listino B	Off.	Box
38732SH0		55,42 €	61,51 €	1	3
38732SH0x3	Offertax3	63,11 €	70,05 €	3	3
38732SH0x6	Offertax6	60,10 €	66,71 €	6	3
38732SH0x9	Offertax9	55,59 €	61,71 €	9	3



Skate Air Piastra Di Azionamento Cromata



Codice	Riferimenti	Listino A	Listino B	Off.	Box
38505000		76,36 €	84,75 €	1	3
38505000x3	Offertax3	71,26 €	79,10 €	3	3
38505000x6	Offertax6	67,87 €	75,34 €	6	3
38505000x9	Offertax9	62,78 €	69,69 €	9	3



Skate Air Piastra Di Azionamento Bianca



Codice	Riferimenti	Listino A	Listino B	Off.	Box
38505SH0		59,19 €	65,70 €	1	3
38505SH0x3	Offertax3	56,07 €	62,24 €	3	3
38505SH0x6	Offertax6	53,27 €	59,13 €	6	3
38505SH0x9	Offertax9	50,47 €	56,02 €	9	3



Cassetta 0,82 Cm Per 38415000
Cassetta 0,82 Cm Per Wc



Codice	Riferimenti	Listino A	Listino B	Off.	Box
38422000		220,13 €	244,35 €	1	3
38422000x3	Offertax3	205,46 €	228,06 €	3	3
38422000x6	Offertax6	195,67 €	217,20 €	6	3
38422000x9	Offertax9	181,00 €	200,91 €	9	3



Uniset 80Mm Per Wc Con Cass.AV1



Codice	Riferimenti	Listino A	Listino B	Off.	Box
38729000		251,66 €	279,34 €	1	3
38729000x3	Offertax3	234,88 €	260,72 €	3	3
38729000x6	Offertax6	223,70 €	248,30 €	6	3
38729000x9	Offertax9	206,92 €	229,68 €	9	3



Grohe Cassetta Di Sciacquo Per Wc, Bianco



Codice	Riferimenti	Listino A	Listino B	Off.	Box
38372SH0		85,90 €	95,35 €	1	3
38372SH0x3	Offertax3	80,17 €	88,99 €	3	3
38372SH0x6	Offertax6	76,36 €	84,76 €	6	3
38372SH0x9	Offertax9	70,63 €	78,40 €	9	3



Canotto + Morsetto X 37104K



Codice	Riferimenti	Listino A	Listino B	Off.	Box
42250000		14,74 €	16,36 €	1	3
42250000x3	Offertax3	13,76 €	15,27 €	3	3
42250000x6	Offertax6	13,10 €	14,55 €	6	3
42250000x9	Offertax9	12,12 €	13,45 €	9	3



Set Alimentazione Acqua Canotto Per Cassetta



Codice	Riferimenti	Listino A	Listino B	Off.	Box
37103SH0		16,64 €	18,47 €	1	3
37103SH0x5	Offertax5	15,76 €	17,50 €	5	3
37103SH0x10	Offertax10	14,97 €	16,62 €	10	3
37103SH0x15	Offertax15	14,19 €	15,75 €	15	3



Smart Ingress

Cassette Grohe



Skate
Cosmopolitan
Piastra Di
Azionamento
Acciaio Inox



Skate
Cosmopolitan
Piastra Di
Azionamento Nero
Ultra Opaco



Skate
Cosmopolitan
Piastra Di
Azionamento Oro
Lucido



Codice	Off.	Listino A	Listino B	Codice	Off.	Listino A	Listino B	Codice	Off.	Listino A	Listino B
38732SD0	1	231,44 €	256,90 €	38732KF0	1	225,83 €	250,68 €	38732GLO	1	208,28 €	231,19 €
38732SD02	2	217,83 €	241,79 €	38732KF02	2	212,55 €	235,93 €	38732GLO2	2	196,03 €	217,59 €



Skate
Cosmopolitan
Piastra Di
Azionamento Oro
Rosa Spazzolato



Skate
Cosmopolitan
Piastra Di
Azionamento Oro
Spazzolato



SKATE
COSMOPOLITAN
PIASTRA DI
AZIONAMENTO
nichel spazzolato



Codice	Off.	Listino A	Listino B	Codice	Off.	Listino A	Listino B	Codice	Off.	Listino A	Listino B
38732DL0	1	208,28 €	231,19 €	38732GN0	1	208,28 €	231,19 €	38732EN0	1	Arrivo	Arrivo
38732DL02	2	196,03 €	217,59 €	38732GN02	2	196,03 €	217,59 €	38732EN02	2	Arrivo	Arrivo



Valvola Av1
Completa Valvola
Av1 Completa



Valv. Scaric. Valv.
Scaric



Valv. Scaric. Valv.
Scaric



Codice	Off.	Listino A	Listino B	Codice	Off.	Listino A	Listino B	Codice	Off.	Listino A	Listino B
42320000	1	32,45 €	36,02 €	43992000	1	51,38 €	57,03 €	43486000	1	21,63 €	24,01 €
42320002	2	30,54 €	33,90 €	43992002	2	48,36 €	53,68 €	43486002	2	20,36 €	22,60 €



Valv. Carico Valv.
Carico



Valvola E Cestello
Per 37594/38661



Riduttore Di Flusso
Per Cassette



Codice	Off.	Listino A	Listino B	Codice	Off.	Listino A	Listino B	Codice	Off.	Listino A	Listino B
37092000	1	43,27 €	48,03 €	42253000	1	64,90 €	72,04 €	42300000	1	19,81 €	21,99 €
37092002	2	40,72 €	45,20 €	42253002	2	61,08 €	67,80 €	42300002	2	18,65 €	20,70 €

Guarnizione Per Valvola Di Scarico Grohe
42310000



Cartuccia Ceramica
28Mm Cartuccia



Canotto + Morsetto X 37104K



Codice	Off.	Listino A	Listino B	Codice	Off.	Listino A	Listino B	Codice	Off.	Listino A	Listino B
42310000	1	5,41 €	6,00 €	46580000	1	54,09 €	60,03 €	42250000	1	14,74 €	16,36 €
42310002	2	5,09 €	5,65 €	46580002	2	50,90 €	56,50 €	42250002	2	13,76 €	15,27 €



CANALINA PRATIC

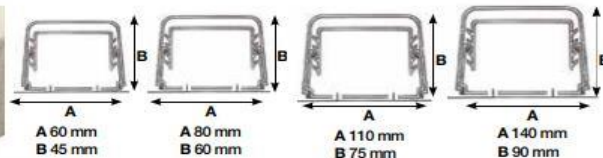
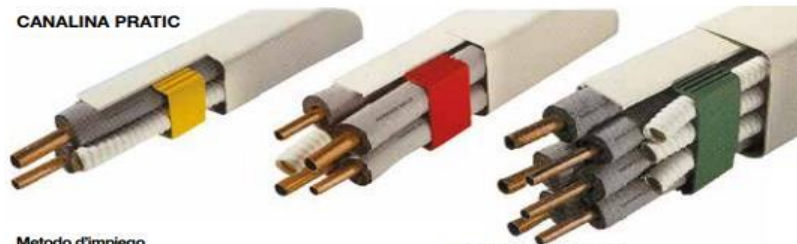

Metodo d'impiego

Fissare la base con i relativi tasselli ad espansione, con passo max 600 mm.

Completare l'impianto utilizzando gli accessori necessari ed inserire i tubi in rame ed i cavi fissandoli in corrispondenza dei tasselli con le staffe di bloccaggio.

Fissare il coperchio ad incastro.

N.B. Le staffe di bloccaggio sono rimovibili con una lieve divaricazione delle pareti

Caratteristiche tecniche

- materiale: PVC UL 94 V0 auto estinguente
- temperatura d'esercizio: -20°C / +60°C
- colore: bianco RAL 9001 verniciabile



Base Canale C/Coperchio 1Mt



Curva Piana

Codice	Riferimenti	Listino A	Listino B	Off.	Box
0612BC	60x45	3,32 €	3,68 €	1	10
0712BC	70x55	3,41 €	3,78 €	1	10
0812BC	80x60	4,97 €	5,52 €	1	10
0912BC	90x65	4,85 €	5,38 €	1	10
1212BC	120x75	5,87 €	6,52 €	1	10
1412BC	140x90	8,89 €	9,87 €	1	10

Codice	Riferimenti	Listino A	Listino B	Off.	Box
0607CP	60x45	2,29 €	2,54 €	1	10
0707CP	70x55	2,14 €	2,38 €	1	10
0807CP	80x60	3,16 €	3,51 €	1	10
0907CP	90x65	2,94 €	3,26 €	1	10
1207CP	120x75	3,61 €	4,01 €	1	10
1407CP	140x90	5,05 €	5,61 €	1	10



Passaggio Muro



Curva A Muro

Codice	Riferimenti	Listino A	Listino B	Off.	Box
0610PM	60x45	2,18 €	2,42 €	1	10
0710PM	70x55	2,00 €	2,22 €	1	10
0810PM	80x60	2,77 €	3,08 €	1	10
0910PM	90x65	2,58 €	2,87 €	1	10
1210PM	120x75	3,20 €	3,55 €	1	10
	140x90				

Codice	Riferimenti	Listino A	Listino B	Off.	Box
0609CM	60x45	2,91 €	3,23 €	1	10
0709CM	70x55	2,70 €	3,00 €	1	10
0809CM	80x60	3,61 €	4,01 €	1	10
0909CM	90x65	3,35 €	3,72 €	1	10
1209CM	120x75	3,91 €	4,34 €	1	10
	140x90				



Tappo Terminale Type 06



Angolo Esterno

Codice	Riferimenti	Listino A	Listino B	Off.	Box
0608IT	60x45	1,79 €	1,98 €	1	10
0708IT	70x55	1,73 €	1,92 €	1	10
0808IT	80x60	2,06 €	2,28 €	1	10

Codice	Riferimenti	Listino A	Listino B	Off.	Box
0606AE	60x45	1,99 €	2,21 €	1	10
0706AE	70x55	1,88 €	2,09 €	1	10
0806AE	80x60	2,29 €	2,54 €	1	10



Cassetta Un.Prdisp. Condizio.

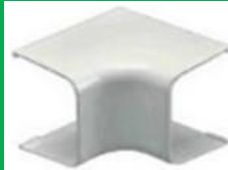

Angolo Interno

Codice	Riferimenti	Listino A	Listino B	Off.	Box
CPC		5,51 €	6,11 €	1	1
CPC144	Offertax144	5,10 €	5,66 €	144	144

Codice	Riferimenti	Listino A	Listino B	Off.	Box
0605AI	60x45	1,99 €	2,21 €	1	10
0705AI	70x55	1,88 €	2,09 €	1	10
0805AI	80x60	2,29 €	2,54 €	1	10



Supporto Antivibrante D. 40 X
H.40 A Terra

Codice	Riferimenti	Listino A	Listino B	Conf.	Box
107042	4 PZ	12,26 €	13,61 €	1	10



Supporto Antivibrante D. 30 X
H.20 A Terra

Codice	Riferimenti	Listino A	Listino B	Conf.	Box
107040	4 PZ	5,45 €	6,05 €	1	10



Raccordo A Y Scarico Condensa

Codice	Riferimenti	Listino A	Listino B	Conf.	Box
0021GY	Racc. "Y"	1,06 €	1,18 €	1	10



Sifone Condensa

Codice	Riferimenti	Listino A	Listino B	Conf.	Box
0024SF	Sifone	2,31 €	2,57 €	1	10



Raccordo Retto Condensa

Codice	Riferimenti	Listino A	Listino B	Conf.	Box
0023GL	Racc. Retto	0,79 €	0,88 €	1	10



Raccordo A "T" Condensa

Codice	Riferimenti	Listino A	Listino B	Conf.	Box
0025GT	Racc. "T"	1,56 €	1,73 €	1	10



Raccordo Diritto Doppio 1/4"

Codice	Riferimenti	Listino A	Listino B	Conf.	Box
81625AB05	D. 1/4"	1,06 €	1,17 €	1	10
81625AC05	D. 3/8"	1,49 €	1,66 €	1	10
81625AD05	D. 1/2"	2,36 €	2,62 €	1	10



Bocchettone Per Raccordo 1/4"

Codice	Riferimenti	Listino A	Listino B	Conf.	Box
81620AB05	D. 1/4"	0,86 €	0,96 €	1	10
81620AC05	D. 3/8"	1,28 €	1,42 €	1	10
81620AD05	D. 1/2"	1,50 €	1,67 €	1	10



Supporto A Pavimento A Cono

Codice	Riferimenti	Listino A	Listino B	Conf.	Box
0501SC		3,17 €	3,51 €	1	10
0502PT		0,52 €	0,58 €	1	10



Supporto A Pavimento Mm.350
Pezzo Singolo

Codice	Riferimenti	Listino A	Listino B	Conf.	Box
0350SP	Cm. 35	5,37 €	5,96 €	1	10
0450SP	Cm. 45	6,22 €	6,90 €	1	10
1000SP	Cm. 1000	9,34 €	10,37 €	1	10
0341TS	Coperchio	1,00 €	1,11 €	1	10



Kit Coppia Staffe Con
Accessori E Barra
SP 12/10

PROMO

Codice	Riferimenti	Listino A	Listino B	Conf.	Box
BSC02	380X380X800	18,24 €	20,25 €	1	10
BSC04	410X380X800	19,43 €	21,57 €	1	10
BSC05	450X350X800	19,43 €	21,57 €	1	10
BSC03	480X380X800	19,43 €	21,57 €	1	10



Tubo Scarico Condensa Mm. 16
Rotolo Mt 30

Codice	Riferimenti	Listino A	Listino B	Conf.	Box
TC16	D. 16	1,00 €	1,10 €	30	300
TC20	D. 20	1,03 €	1,15 €	30	300



KIT VALIGETTA CON GRUPPO
MANOMETRICO GM-2-S2-C1-80-
PF-KIT-V - R32/410

Codice	Riferimenti	Listino A	Listino B	Conf.	Box
05007050		158,34 €	175,76 €	1	10



Bilancia elettronica per bombola
a gas Kg100 - 5 grammi

Codice	Riferimenti	Listino A	Listino B	Conf.	Box
BE100/5		211,08 €	234,29 €	1	10



Cartellatrice Universale
Per Tubi In Pollici Da 3/16" A
5/8"
Per Tubi In Millimetri Da 5 A 16

Codice	Riferimenti	Listino A	Listino B	Conf.	Box
CUE		30,89 €	34,29 €	1	10



Pompa Scarico Condensa 600
Lt/H Zz Nth10.1

Codice	Riferimenti	Listino A	Listino B	Conf.	Box
117310		96,51 €	107,12 €	1	30
117310x2	Offertax2	91,43 €	101,49 €	2	30
117310x5	Offertax5	86,86 €	96,41 €	5	30
117310x10	Offertax10	82,29 €	91,34 €	10	30



Climatizzatore Portatile
Compatto Olimpia Splendid Che
Deumidifica Dolceclima
Compact 8 P 2,64Kw A Gas R290

Codice	Riferimenti	Listino A	Listino B	Conf.	Box
01921		580,45 €	644,30 €	1	30



UNICO EVO
Il più silenzioso ed
efficiente, con motore
inverter e gas R290 HP 20



UNICO EVO
Il più silenzioso ed
efficiente, con motore
inverter e gas R290 HP 25

Codice	Riferimenti	Listino A	Listino B	Conf.	Box
OL02453	20 Hp R290	2729,59 €	3029,84 €	1	UI.
OL02455	25 Hp R290	2884,61 €	3201,92 €	1	UI.



Pinza amperometrica AC/DC

Codice	Riferimenti	Listino A	Listino B	Conf.	Box
DT-333		126,73 €	140,67 €	1	10



Cercafughe elettronico

Codice	Riferimenti	Listino A	Listino B	Conf.	Box
29027007	Seeker	200,29 €	222,32 €	1	10



Kit Cartellatrice Universale
Per Tubi In Pollici Da 3/16" A 5/8"
Per Tubi In Millimetri Da 5 A 16
Completa Di:
- Tagliatubi Da 3 A 22 Mm
- Sbatutubi Girevoli Con Lama Di
Ricambio

Codice	Riferimenti	Listino A	Listino B	Conf.	Box
CT806AMLC		73,08 €	81,12 €	1	10



POMPE VUOTO



SERIE BM Doppio stadio
BM Double stage series

Codice	Riferimenti	Listino A	Listino B	Conf.	Box
PV2BM-71LM	DS2BM-71LM	310,94 €	345,15 €	1	30
PV4BM-127LM	DS4BM-127LM	390,10 €	433,01 €	1	30
PV8BM-241LM	DS8BM-241LM	588,72 €	653,48 €	1	30
PV10BM-297LM	DS10BM-297LM	685,84 €	761,29 €	1	30



Deumidificatore G3 Ferrari 10 Lt
210W

Codice	Riferimenti	Listino A	Listino B	Conf.	Box
G9000100		189,13 €	209,93 €	1	30



cod. 02133
Climatizzatore UNICO
EDGE 30 HP RFA R410
On Off



cod. 02115
Climatizzatore UNICO
EDGE 30 HP RFA R410
On Off

Codice	Riferimenti	Listino A	Listino B	Conf.	Box
OL02133	30 Hp RFA R410	2453,26 €	2723,12 €	1	UI.
OL02115	30 Hp EVA	2710,25 €	3008,38 €	1	UI.



Clima Nexya S4

E



Codice	Riferimenti	Listino A	Listino B	Conf.	Box
NS409	9000 Btu	589,06 €	653,86 €	1	1 Kit
NS412	12000 Btu	643,97 €	714,81 €	1	1 Kit
NS418	18000 Btu	1103,17 €	1224,52 €	1	1 Kit
NS424	24000 Btu	1343,57 €	1491,36 €	1	1 Kit

Clima Multisplit Nexya S4 E



Codice	Riferimenti	Listino A	Listino B	Conf.	Box
CEMYH18EI	U.E. 18000	Arrivo	Arrivo	1	UE
SENEH09	U.I. 9000	Arrivo	Arrivo	1	UI
SENEH12	U.I. 12000	Arrivo	Arrivo	1	UI



Codice	Riferimenti	Listino A	Listino B	Conf.	Box
02303	S2 E 6	4158,28 €	4615,69 €	1	UE
02304	S2 E 8	4530,27 €	5028,60 €	1	UE
02305	S2 E 10	4620,31 €	5128,54 €	1	UE
02306	S2 E 12	5983,30 €	6641,46 €	1	UE
02307	S2 E 14	6867,32 €	7622,72 €	1	UE
02308	S2 E 16	7395,57 €	8209,08 €	1	UE
02309	S2 E 12 T	5852,37 €	6496,13 €	1	UE
02310	S2 E 14 T	6160,40 €	6838,04 €	1	UE
02311	S2 E 16 T	6622,43 €	7350,90 €	1	UE

Unità Esterna commerciale



Codice	Riferimenti	Listino A	Listino B	Conf.	Box
OS-CANCH18EI	U.E. 18000	1357,40 €	1506,71 €	1	UE
OS-CANCH124EI	U.E. 24000	1666,88 €	1850,24 €	1	UE
OS-CANCH36EI	U.E. 36000	2660,50 €	2953,16 €	1	UE
OS-CANCH36EI	U.E. 36000	2676,79 €	2971,24 €	1	UE
OS-CANCH48EI	U.E. 48000	3686,69 €	4092,23 €	1	UE



Ventilconvettore SI Smart
Comando a Bordo B0855



Scopri tutte le Offerte Olimpia



Codice	Riferimenti	Listino A	Listino B	Conf.	Box
02122	200 B	605,19 €	671,76 €	1	1 Kit
02123	400 B	658,20 €	730,60 €	1	1 Kit
02124	600 B	742,13 €	823,76 €	1	1 Kit
02125	800 B	865,82 €	961,06 €	1	1 Kit
02126	1000 B	914,41 €	1015,00 €	1	1 Kit

Ventilconvettore Unico



Codice	Riferimenti	Listino A	Listino B	Conf.	Box
99283	1200 Kw 270	776,65 €	862,08 €	1	UI
99281	1400 Kw 380	1031,62 €	1145,10 €	1	UI



Ventilconvettore Bi2 Wall

Codice	Riferimenti	Listino A	Listino B	Conf.	Box
01784	400 V2V	847,06 €	940,24 €	1	UI
01785	600 V2V	919,81 €	1020,99 €	1	UI
01786	800 V2V	992,52 €	1101,70 €	1	UI
01787	400 V3V	885,56 €	982,98 €	1	UI
01788	600 V3V	954,02 €	1058,96 €	1	UI
01789	800 V3V	1018,17 €	1130,17 €	1	UI
02457	800 V4V	1131,27 €	1255,70 €	1	UI
02461	1400 V3V	1172,18 €	1301,13 €	1	UI

Ue Sherpa S2 - S3



Sherpa Aquadue Tower S2



Sherpa Aquadue Tower S3



Codice	Riferimenti	Listino A	Listino B	Conf.	Box
02004	U.E. S2	4004,60 €	4445,10 €	1	UE
02044	U.I. TOWER S2	11062,02 €	12278,84 €	1	UI



Idraclean Airsan Ag Flacone 0,75 Kg

Idraclean Airsan Ag Da 5 Kg Pulizia E Sanificazione Impianti Aria Condizionata 5 Lt

Codice	Riferimenti	Listino A	Listino B	Conf.	Box
I.AIRSB	Kg. 0,75	12,83 €	14,24 €	1	1
I.AIRST5	Lt. 5	39,87 €	44,25 €	1	1

Prodotto acido per pulitura Radiatori: Alluminio. 10%-30% secondo la consistenza del deposito calcareo. Fare Circolare e neutralizzare con Max N

MAX DA: Prodotto liquido specifico per Alluminio



Codice	Riferimenti	Listino A	Listino B	Conf.	Box
10105025	Kg. 10	25,86 €	28,70 €	1	1
10105030	Kg. 5	15,08 €	16,74 €	1	1



Trattamento Acque



Tipo: Compact Coffee

Addolcitore cabinato in due modelli dalle dimensioni compatte. con valvola automatica elettronica a rigenerazione volume/tempo con salamoia e bombola in materiale composito con liner, in PE rivestito in fibra di vetro e resina epossidica in un unico corpo. Completo di by-pass. Accessori: disinfezione automatica resine (coD. NCSAL05) installata direttamente sulla valvola, tubo di scarico in PVC e valvola di sicurezza pozzetto salamoia con galleggiante (coD.RF09959). VALVOLE RUNXIN

- Ampio display LCD retroilluminato • Adotta testate ermetiche ceramica alto grado
- Sistema per controllo di flussi affidabile • Indicazione di mancata alimentazione elettrica
- Blocco pulsanti in assenza di operazioni un minuto • Miscelatore di durezza integrato

Compact E Slim ES
 • Alimentazione 230V 50 Hz
 • Pres. min 2 bar - max 6 bar-5÷50° C

Codice	Riferimenti	Listino A	Listino B	Conf.	Box
NCCVE12ENJRBP	12 ENJRBP	658,42 €	730,84 €	1	1
NCCVE12ESLRBP	12 ESLRBP	676,93 €	751,39 €	1	1
NCCVE18ESLRBP	18 ESLRBP	740,20 €	821,63 €	1	1
NCCVE28ESLRBP	28 ESLRBP	1088,44 €	1208,17 €	1	1
NCBTE70E268BP	70 E268BP	1889,93 €	2097,82 €	1	1



Filtro Anticalcare Magnetico
 Freecal Indicato Per Lavatrice, Lavastoviglie, Scaldabagno, Doccia, Attacchi Da 1/2" M, 3/4 Pollici



Sale Addolcimento Acqua Sacco 25kg



Salvalavatrice Da 3/4" C/Sali

Codice	Off.	Listino A	Listino B	Codice	Off.	Listino A	Listino B	Codice	Off.	Listino A	Listino B
DGELTF	1	14,62 €	16,22 €	SALE25	1	9,91 €	11,00 €	SLG	1	7,59 €	8,43 €



Inibitore di corrosione Prodotto non acido per la protezione delle caldaie e impianti da fenomeni corrosivi ed incrostazioni



Decapante per nuovi impianti di riscaldamento il prodotto rimuove residui di saldatura, grassi, e residui oleosi, fanghi e contaminanti provenienti dall'installazione. Risanante non acido per impianti parzialmente compromessi



Risanante energetico alcalino per la rimozione di ossidi e depositi per circuito di riscaldamento molto compromessi (max 1 settimana)



Dosaggio 1%volume

Dosaggio 1%volume

Dosaggio 1+10% sul volume infunzione dello sporco

Codice	Off.	Listino A	Listino B	Codice	Off.	Listino A	Listino B	Codice	Off.	Listino A	Listino B
10106001	1	13,29 €	14,75 €	10106013	1	13,36 €	14,83 €	10106010	1	13,57 €	15,07 €



Dosatore Polifosfati
Ghiera 1/2"



Dosamax Blu Stop



Dosamax Blu Stop Ghiera
1/2"



Kit Dosatore Polifosfati
Per Immergas Victrix



Codice	Off.	Listino A	Listino B	Codice	Off.	Listino A	Listino B	Codice	Off.	Listino A	Listino B
DBSS	1	41,79 €	46,38 €	DBSG	1	41,96 €	46,57 €	3017323	1	86,27 €	95,76 €
DBSS5	5	37,61 €	41,75 €	DBSG5	5	37,76 €	41,92 €	30173235	5	77,64 €	86,18 €



Maxpoliquick Per
Dosatori
Proporzion.
Ricariche 6 Pz



Filtro Defangatore Magnetico



Rosetta Riscal.
Gambo Lungo
Bianca "

Codice	Off.	Listino A	Listino B	Codice	Off.	Listino A	Listino B	Codice	Off.	Listino A	Listino B
10160300	5	6,26 €	6,95 €	HSDPL	1	47,63 €	52,87 €	RARU	24	0,17 €	0,19 €
1016030010	10	5,64 €	6,26 €	HSDPL5	5	42,87 €	47,58 €	RARU120	120	0,15 €	0,17 €



Neutralizzatore Acida Di
Condensa Caldaie Attacco
3/4" - 3/4" M H. 220 X L.
47 Mm



Kit Radiatore
Bianco 1"X3/8"



Kit Salvacaldaie:
Composta Da
Defangatore
Magnetico, Filtro
Neutralizzatore Di
Condensa, Dosatore
Polifosfati

Codice	Off.	Listino A	Listino B	Codice	Off.	Listino A	Listino B	Codice	Off.	Listino A	Listino B
NEUTRAWATER-B	1	23,25 €	25,80 €	SK1C	1	4,25 €	4,72 €	10112045	1	124,00 €	137,64 €
NEUTRAWATER-B5	5	20,92 €	23,22 €	SK1C25	25	3,83 €	4,25 €	101120455	5	111,60 €	123,88 €

Coppia Mensola Rad. All. Piat.



Kit Termo 3/8"X 1/2" Tasca D. 16 Con Testina
Termo



Valvola + Detentore 3/8" Usc.1/2"



Codice	Off.	Listino A	Listino B	Codice	Off.	Listino A	Listino B	Codice	Off.	Listino A	Listino B
CMRA	1	1,97 €	2,19 €	170T3010S	1	29,94 €	33,23 €	V+DEA	1	11,28 €	12,52 €
CMRA25	25	1,78 €	1,97 €	170T3010S25	25	26,77 €	29,71 €	V+DEA5	5	10,08 €	11,19 €



Sportello Per
Contatore Gas H.
600 Larg. 400 Prof.
20

Sportello Per Contatore Acqua 300X400X20
Zincato



Cassetta Gas
Zin.500X400X250Z

Codice	Off.	Listino A	Listino B	Codice	Off.	Listino A	Listino B	Codice	Off.	Listino A	Listino B
SG6040Z	1	17,39 €	19,30 €	SA3040Z	1	16,27 €	18,06 €	CGG04Z	1	31,88 €	35,38 €



Termo arredo
Brand Sira
o
brand Lazzarini

Codice	Riferimenti	Listino B	Listino B	Box
S45X80B	40 Bianco	69,24 €	76,86 €	5
S45X110B	40 Bianco	64,26 €	71,33 €	5
S45X120B	40 Bianco	84,35 €	93,63 €	5
S45X140B	40 Bianco	92,55 €	102,73 €	5
S50X80B	45 Bianco	66,30 €	73,59 €	5
S50X120B	45 Bianco	88,87 €	98,64 €	5
S50X140B	45 Bianco	109,39 €	121,43 €	5
S45X80C	40 Cromo	124,20 €	137,86 €	5
S45X120C	40 Cromo	160,17 €	177,78 €	5
S45X140C	40 Cromo	170,72 €	189,50 €	5
S50X80C	45 Cromo	128,97 €	143,16 €	5
S50X120C	45 Cromo	164,04 €	182,08 €	5
S50X140C	45 Cromo	187,88 €	208,55 €	5



Radiatore Alluminio Modello
Primavera



Codice	Riferimenti	Listino A	Listino B	Off.	Box
P500	500	12,40 €	13,77 €	1	1
P600	600	19,88 €	22,07 €	1	1

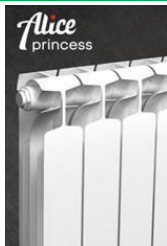

Radiatore Alluminio Modello
Alice
Princess



Codice	Riferimenti	Listino A	Listino B	Off.	Box
AP50	500 580	20,28 €	22,51 €	1	10
AP60	600 680	21,93 €	24,35 €	1	10
AP70	700 780	23,50 €	26,08 €	1	10
AP80	800 880	25,38 €	28,18 €	1	10



Radiatore Alluminio Modello
Alice+



Codice	Riferimenti	Listino A	Listino B	Off.	Box
A+100	1000 1060	69,28 €	76,90 €	1	2+3
A+120	1200 1260	76,18 €	84,56 €	1	2+3
A+140	1400 1460	81,61 €	90,59 €	1	2+3
A+160	1600 1660	88,60 €	98,35 €	1	2+3
A+180	1800 1860	93,03 €	103,26 €	1	2+3
A+200	2000 2060	102,00 €	113,23 €	1	2+3



Scaldasalviette Elettrico
Bolzano Ds2 Dr Bianco

E-BOLZANO - Manuale istruzioni.pdf

E-BOLZANO - scheda tecnica.pdf

Codice	Riferimenti	Listino B	Listino B	Box
S50X80BE	50	249,50 €	276,94 €	2
S50X120BE	50	268,65 €	298,20 €	2
S50X160BE	50	283,14 €	314,28 €	2
S50X180BE	50	303,85 €	337,27 €	2
S60X120BE	60	280,02 €	310,83 €	2
S60X160BE	60	299,19 €	332,11 €	2
S60X180BE	60	338,01 €	375,19 €	2

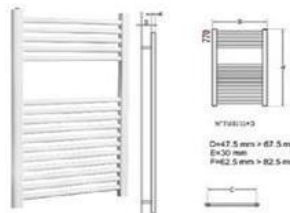

Termo Arredo Import
40 int. Per 80 cm. H.
colore Bianco

Import Export

Codice	Riferimenti	Listino A	Listino B	Off.	Box
S45X80OF	40 Bianco	24,54 €	27,24 €	1	1



Radiatore Alluminio Modello
Alice Royal



Codice	Riferimenti	Listino A	Listino B	Off.	Box
AR50	500 580	20,28 €	22,51 €	1	10
AR60	600 680	21,93 €	24,35 €	1	10
AR70	700 780	23,50 €	26,08 €	1	10
AR80	800 880	25,38 €	28,18 €	1	10



Radiatore Alluminio Modello
Rubino



Codice	Riferimenti	Listino A	Listino B	Off.	Box
R100	1000 1060	62,31 €	69,16 €	1	5
R120	1200 1260	67,18 €	74,57 €	1	5
R140	1400 1460	72,03 €	79,95 €	1	5
R160	1600 1660	76,90 €	85,36 €	1	5
R180	1800 1860	81,65 €	90,64 €	1	5
R200	2000 2060	89,77 €	99,64 €	1	5



Kit1 Kit Coassiale M/F D. 60/100
Compatibilità: Ariston-
Berettariello--
Vaillant-Atlantichthermal



**SCARICO FUMI
CONDENSAZIONE**

Codice	Riferimenti	Listino A	Listino B	Off.	Box
107692	Ariston	38,98 €	43,26 €	1	10
107697	Bosch	59,09 €	65,58 €	1	10



Kit Scarico Fumo Tipo Vaillant
Kit 8 Coass. C /Ter.Pbt 1,00



**SCARICO FUMI
CONVENZIONALI**

Codice	Riferimenti	Listino A	Listino B	Off.	Box
KSFTV	Ariston	50,14 €	55,65 €	1	10
	Bosch	Arrivo	Arrivo	1	10



Scaldabagno A Gas
Camera Stagna Mini



Scheda Tecnica

Codice	Riferimenti	Listino A	Listino B	Off.	Box
8112631	12 Lt. Gpl	559,93 €	621,52 €	1	6
8112630	12 Lt. Met	559,93 €	621,52 €	1	6
8112632	16 Lt. Gpl	686,14 €	761,62 €	1	6
8112633	16 Lt. Met	686,14 €	761,62 €	1	6



Caldia Sime VERA a
Condensazione



Codice	Riferimenti	Listino A	Listino B	Off.	Box
VERAHE25	25 KW	1459,94 €	1620,54 €	1	6
VERAHE30	30 KW	1795,01 €	1992,47 €	1	6
8097575	CASSONE	252,39 €	280,15 €	1	6



Scaldabagno Bandini
Braun Volano Termico
Sep 5 anni di garanzia



Scheda Tecnica

Codice	Riferimenti	Listino A	Listino B	Off.	Box
SV50C5VSEP	50 Lt.	395,02 €	438,47 €	1	1
SV80C5VSEP	80 Lt.	418,26 €	464,26 €	1	1
SV100C5VSEP	100 Lt.	460,08 €	510,69 €	1	1



Junkers Scaldabagno
Therm 4204 Nox Lt 10



Codice	Riferimenti	Listino A	Listino B	Off.	Box
7736504907	Metano	338,63 €	375,88 €	1	1
7736504909	Gpl	338,63 €	375,88 €	1	1



PANNELLI GRUPPO TP COMPOSTO DA:
1) Art. 8500073 SIME PLANO 272
2) Collettore solare piano struttura in
allum. navale arricchito al magnesio Pz. 2
3) 8500301 KIT Connessione dei due
Collettore solare SIMESOL 1
4) 8500005 Telaio di fissaggio
5) 8106952 "KIT GI 1CP composto da:
A) GR. IDR. SOLARE 1C TERMOSOLIS
B) KIT STAFFA SUPP. VASO ESP. SOL.
C) ASS. TUBO CORRUG. COLL. VASO ESP."

Codice	Riferimenti	Listino A	Listino B	Off.	Box
8500073TP	Tetto Piano	2844,69 €	3157,60 €	1	1
8500073TF	Tetto Inclinato	2887,56 €	3205,19 €	1	1

SIME NATURAL 300/5.44 S

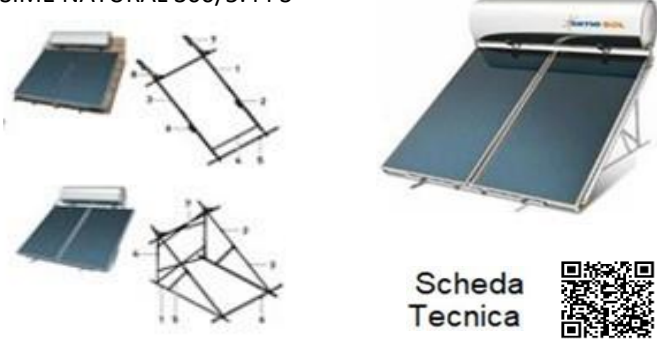

Scheda
Tecnica



Codice	Riferimenti	Listino A	Listino B	Off.	Box
8500269	Piano/Incl.	2929,18 €	3251,39 €	1	1



Scheda
Tecnica



Installabile a muro nella versione 110 lt. e a
basamento nelle versioni 200 e 300 litri.
Serbatoio in acciaio con vetrificazione a doppio
strato. Anodo di magnesio anticorrosione
sostituibile. Serpentino di riscaldamento avvolto
esternamente al bollitore. Funzione anti-legionella
automatica. Elevata silenziosità. Serpentino
interno per collegamento ad impianto solare
termico (versione 300 S). Contatto per
integrazione con impianto fotovoltaico.
Resistenza elettrica integrata per assicurare
comfort anche nelle condizioni più estreme. Il prodotto
raggiunge i requisiti necessari ai fini
della detrazione fiscale del 65% e 110%

Codice	Riferimenti	Listino A	Listino B	Off.	Box
8115842	Lt 110	1775,39 €	1970,68 €	1	1
8115843	Lt 200	2539,79 €	2819,17 €	1	1
8115846	Lt 200 S	2704,49 €	3001,98 €	1	1
8115845	Lt 300 S	3032,96 €	3366,58 €	1	1



Codice	Eco contributo GSE	Contributo GSE
8500269	Eco contributo GSE	2.055,00 €
8115842	Eco contributo GSE	400,00 €
8115843	Eco contributo GSE	400,00 €
8115845	Eco contributo GSE	700,00 €



Valvola A Sfera Blu
A P/ Totale
Squadra Con
Attacco Girevole
Portatermometro



Gruppo
Riempimento 1/2"
C/M.



Raccordo girevole diritto
giallo per connessione
defangatore
compatto/caldaia.
Comprensivo di due
guarnizioni piane di tenuta.

Codice	Pz	Listino A	Listino B
87226AF12	1	35,02 €	38,87 €

Codice	Pz	Listino A	Listino B
GR12M	1	42,63 €	47,32 €

Codice	Pz	Listino A	Listino B
CDGFFG	1	12,95 €	14,37 €



Valvola A Sfera Rosso A
P/ Totale Squadra Con
Attacco Girevole
Portatermometro



Valvola Sfiato Aria
Per Impianti Solari
Icma



Gruppo di circolazione
di ritorno per circuiti
primari di impianti
solari, d. 3/4"

Codice	Pz	Listino A	Listino B
87226AF11	1	35,02 €	38,87 €

Codice	Pz	Listino A	Listino B
93S110AD05	1	10,48 €	11,64 €

Codice	Pz	Listino A	Listino B
93S002AE05G	1	378,30 €	419,91 €



S142 Doppia Valvola
Ritegno



Kit solare caldaia
termostatico



Kit Integrazione Solare
Cal.

Codice	D.	Listino A	Listino B
93S142AE05	1/2"	12,27 €	13,62 €

Codice	D.	Listino A	Listino B
93S170AE0645	3/4"	162,66 €	180,55 €

Codice	D.	Listino A	Listino B
KSCM34	3/4"	383,40 €	425,58 €



Miscelatore
termostatico solare
attacchi maschio 1" via
laterale



Termostufa Pellet
Mod. Sofia 18 Kw
Antracite



Termostufa Pellet Mod.
Sofia 18 Kw Bordeaux

Codice	Pz	Listino A	Listino B
93S112AE05	1	65,79 €	73,02 €

Codice	Kw	Listino A	Listino B
SOFIA18AN	18	3265,92 €	3625,17 €

Codice	Kw	Listino A	Listino B
SOFIA18BO	18	3265,92 €	3625,17 €

**IMPIANTI A PANNELLI SOLARI
SOLAR PANEL SYSTEMS**



Miscelatore
Termostatico 1/2"
Acqua Sanitaria

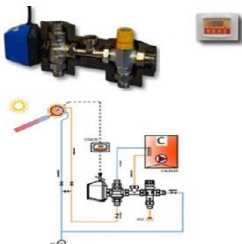

Kit Solare
Miscelatore



Collettore per
impianti
sottopavimento 1"

Codice	D.	Listino A	Listino B
MTS12	1/2"	58,09 €	64,48 €
MTS34	3/4"	82,95 €	92,08 €
MTS10	1"	89,69 €	99,56 €

Codice	D.	Listino A	Listino B
KSCT34	3/4"	232,13 €	257,67 €

Codice	vie	Listino A	Listino B
87K023PQ06	5	243,48 €	270,26 €
87K023PK06	6	275,36 €	305,65 €
87K023PR06	7	291,83 €	323,93 €
87K023PL06	8	316,07 €	350,84 €



Tubo Lineare in Acciaio Monoparete



Fascetta Di Bloccaggio Inox D. 80 Pz. 1



Guarnizione Siliconica D. 80 Pz. 1

Codice	Cm.	Listino A	Listino B	Codice	Cm.	Listino A	Listino B	Codice	Cm.	Listino A	Listino B
MLA25080	0,25	8,67 €	9,62 €	FB080	80	3,55 €	3,94 €	GS0800	80	2,22 €	2,46 €
MLA500080	0,50	11,21 €	12,45 €	FB100	100	3,88 €	4,31 €	GS0100	100	2,77 €	3,08 €
MLA100080	1,00	23,46 €	26,04 €	FB120	120	4,11 €	4,56 €	GS0120	120	3,33 €	3,69 €
MLA250100	0,25	9,68 €	10,74 €	FB150	150	4,56 €	5,06 €	GS0150	150	4,44 €	4,92 €
MLA500100	0,50	16,33 €	18,13 €	FB180	180	4,99 €	5,54 €	GS0180	180	4,99 €	5,54 €
MLA100100	1,00	26,16 €	29,03 €	FB200	200	5,44 €	6,04 €	GS0200	200	5,57 €	6,18 €

MLA250120	0,25	10,56 €	11,72 €
MLA500120	0,50	19,13 €	21,23 €
MLA100120	1,00	25,33 €	28,11 €
MLA250150	0,25	12,39 €	13,75 €
MLA500150	0,50	23,66 €	26,27 €
MLA100150	1,00	36,67 €	40,70 €

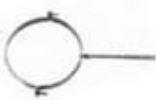

Supporto Per Solaio E/O Muro D. 80



Raccordo A T 135° Inox D. 180

Codice	Cm.	Listino A	Listino B	Codice	Cm.	Listino A	Listino B	Codice	Cm.	Listino A	Listino B
MLA250180	0,25	15,22 €	16,90 €	SPS080	80	35,69 €	39,61 €	RT135080	80	71,07 €	78,89 €
MLA500180	0,50	27,90 €	30,97 €	SPS100	100	66,95 €	74,31 €	RT135100	100	71,07 €	78,89 €
MLA100180	1,00	43,67 €	48,48 €	SPS120	120	75,32 €	83,61 €	RT135120	120	60,13 €	66,74 €
MLA250200	0,25	16,00 €	17,76 €	SPS150	150	47,39 €	52,60 €	RT135150	150	74,35 €	82,53 €
MLA500200	0,50	28,90 €	32,08 €	SPS180	180	100,42 €	111,47 €	RT135180	180	102,88 €	114,19 €
MLA100200	1,00	46,34 €	51,44 €	SPS200	200	100,95 €	112,06 €	RT135200	200	107,56 €	119,39 €



Curva 45° O Inox D. 180



Curva 90° O Inox D. 180



Raccordo A T 90° Inox D. 180

Codice	Cm.	Listino A	Listino B	Codice	Cm.	Listino A	Listino B	Codice	Cm.	Listino A	Listino B
C45080	80	19,68 €	21,85 €	C90080	80	26,11 €	28,98 €	RT90080	80	40,28 €	44,71 €
C45100	100	20,99 €	23,30 €	C90100	100	27,12 €	30,11 €	RT90100	100	42,08 €	46,71 €
C45120	120	17,69 €	19,64 €	C90120	120	29,02 €	32,21 €	RT90120	120	34,66 €	38,48 €
C45150	150	19,90 €	22,09 €	C90150	150	25,75 €	28,58 €	RT90150	150	39,23 €	43,54 €
C45180	180	21,54 €	23,91 €	C90180	180	43,97 €	48,81 €	RT90180	180	65,51 €	72,71 €
C45200	200	30,57 €	33,93 €	C90200	200	54,35 €	60,33 €	RT90200	200	72,97 €	81,00 €



Tappo Con Scarico E/O Cieco Inox D. 180



Supporto Per Solaio E/O Muro D. 180



Raccordo A T 135° Inox D. 180

Codice	Cm.	Listino A	Listino B	Codice	Cm.	Listino A	Listino B	Codice	Cm.	Listino A	Listino B
TCS080	80	29,79 €	33,06 €	SPS080	80	35,69 €	39,61 €	RT135080	80	71,07 €	78,89 €
TCS100	100	31,68 €	35,16 €	SPS100	100	66,95 €	74,31 €	RT135100	100	71,07 €	78,89 €
TCS130	120	33,57 €	37,26 €	SPS120	120	75,32 €	83,61 €	RT135120	120	60,13 €	66,74 €
TCS150	150	38,13 €	42,32 €	SPS150	150	47,39 €	52,60 €	RT135150	150	74,35 €	82,53 €
TCS180	180	41,00 €	45,51 €	SPS180	180	100,42 €	111,47 €	RT135180	180	102,88 €	114,19 €
TCS200	200	32,32 €	35,87 €	SPS200	200	100,95 €	112,06 €	RT135200	200	107,56 €	119,39 €



Cappello A Botte Acciaio Antivento D. 180



Terminale Eolico Innesto Maschio D. 180



Cappello Parapioggia Inox D. 180

Codice	Cm.	Listino A	Listino B	Codice	Cm.	Listino A	Listino B	Codice	Cm.	Listino A	Listino B
CB080	80	35,02 €	38,87 €	CR080	80	Arrivo	Arrivo	CPP080	80	19,53 €	21,68 €
CB100	100	80,56 €	89,42 €	CR100	100	122,97 €	136,49 €	CPP100	100	21,66 €	24,04 €
CB120	120	85,14 €	94,51 €	CR125	120	122,97 €	136,49 €	CPP120	120	20,17 €	22,39 €
CB150	150	50,17 €	55,69 €	CR150	150	126,43 €	140,34 €	CPP150	150	23,58 €	26,18 €
CB180	180	107,56 €	119,39 €	CR180	180	143,39 €	159,16 €	CPP180	180	27,52 €	30,54 €
CB200	200	110,47 €	122,62 €	CR200	200	151,53 €	168,20 €	CPP200	200	29,94 €	33,24 €



Copriscaldaia -
Copriscaldino

Codice	H	L	P	Listino A	Listino B	
P160P		800	480	300	49,21 €	54,62 €
P167P	BC85	850	500	350	61,03 €	67,74 €
P170P		870	500	350	75,35 €	83,63 €
BC102S	BC102S	920	500	350	81,14 €	90,07 €
P200P	BC102	1020	550	450	81,14 €	90,07 €
P213P	BC108	1060	600	450	81,14 €	90,07 €
P236P	BC125	1200	600	450	101,32 €	112,47 €



Esalatore Fumi Colore
Bianco

Codice	Riferimenti	Listino A	Listino B	Off.	Box
E110	D. 110	19,93 €	22,12 €	1	1
E120	D. 120	19,93 €	22,12 €	1	1
E130	D. 130	19,93 €	22,12 €	1	1
E140	D. 140	19,93 €	22,12 €	1	1



Riduttore Pressione
Pesante

Codice	Riferimenti	Listino A	Listino B	Off.	Box
RB1\2P	1/2"	35,34 €	39,23 €	1	1
RB3\4P	3/4"	47,41 €	52,62 €	1	1
RB1P	1"	66,33 €	73,62 €	1	1
RB11\4P	1 1/4"	102,02 €	113,24 €	1	1
RB11\2P	1 1/2"	105,66 €	117,28 €	1	1
RB2P	2"	182,17 €	202,21 €	1	1



Valvola Scald. Pes.
Leva 1/2" Mf



Valvola Scald.
Pesante 1/2" Mf



Valvola
Multifunzione 3/4"
Mf

Codice	Off.	Listino A	Listino B	Codice	Off.	Listino A	Listino B	Codice	Off.	Listino A	Listino B
VSSL12	1	3,04 €	3,37 €	VSS12	1	2,53 €	2,81 €	V1403\4	1	13,66 €	15,17 €



Resistenza Scalda
F.11/4" 1200W



Resistenza
Scaldabagno
1200W



Valvola Scald. Con
Rid. Pres.

Codice	Off.	Listino A	Listino B	Codice	Off.	Listino A	Listino B	Codice	Off.	Listino A	Listino B
RDT12	1	9,74 €	10,81 €	RDF12	1	9,36 €	10,39 €	VSRP	1	8,42 €	9,34 €



Termostato
Scaldabagno
Univer.

Resistenza Scaldabagno Faston Prolungati
1200W



Guarnizione flangia
75 Integrale



Guar. Resistenza
Flangia Pz. 12x



Codice	Off.	Listino A	Listino B	Codice	Off.	Listino A	Listino B	Codice	Off.	Listino A	Listino B
TUS	1	4,81 €	5,34 €	RDAP12	1	9,36 €	10,39 €	GCI75	1	1,21 €	1,35 €
								GRT	1	0,17 €	0,19 €



Tubo Alluminio
Estensibile

Codice	Riferimenti	Listino A	Listino B	Off.	Box
TA80	mm 80	10,95 €	12,16 €	1	1
TA100	mm 100	12,89 €	14,31 €	1	1
TA120	mm 120	15,58 €	17,30 €	1	1
TA130	mm 130	16,54 €	18,36 €	1	1
TA140	mm 140	18,47 €	20,50 €	1	1
TA150	mm 150	19,47 €	21,62 €	1	1
TA160	mm 160	20,70 €	22,98 €	1	1
TA180	mm 180	23,71 €	26,32 €	1	1
TA200	mm 200	25,90 €	28,75 €	1	1
TA300	mm 300	44,66 €	49,58 €	1	1



Riduttore Pressione
Pesante con bocchettoni

Codice	Riferimenti	Listino A	Listino B	Off.	Box
RB1\2PB	1/2"	31,05 €	34,46 €	1	1
RB3\4PB	3/4"	49,72 €	55,18 €	1	1
RB1PB	1"	55,77 €	61,91 €	1	1
RB11\4PB	1 1/4"	97,46 €	108,18 €	1	1



Riduttore Pressione Norm.
1/2"

Codice	Riferimenti	Listino A	Listino B	Off.	Box
RB1\2N	1/2"	22,57 €	25,05 €	1	1
RB3\4N	3/4"	25,96 €	28,82 €	1	1



Scaldabagno Bandini Braun
Vetroporcellnatao Vert. 12 Lt
Sopralavello 2 Anni Garanzia



Codice	Riferimenti	Listino A	Listino B	Off.	Box
A12SP2A		120,66 €	120,66 €	1	1
A12SP2Ax5	Offertax5	114,91 €	114,91 €	5	1
A12SP2Ax10	Offertax10	106,29 €	106,29 €	10	1
A12SP2Ax15	Offertax15	96,53 €	96,53 €	15	1

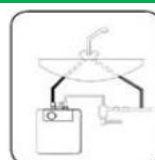

Scaldabagno Bandini Braun
Vetroporcellnatao Vert. 12 Lt
Sottolavello 2 Anni Garanzia



Codice	Riferimenti	Listino A	Listino B	Off.	Box
A12ST2A		113,12 €	113,12 €	1	1
A12ST2Ax5	Offertax5	107,73 €	107,73 €	5	1
A12ST2Ax10	Offertax10	99,65 €	99,65 €	10	1
A12ST2Ax15	Offertax15	90,49 €	90,49 €	15	1



Scaldabagno Bandini Braun
Vetroporcellnatao Vert. 30 Lt 2
Anni Garanzia



Codice	Riferimenti	Listino A	Listino B	Off.	Box
SE302A		170,93 €	170,93 €	1	1
SE302Ax5	Offertax5	162,79 €	162,79 €	5	1
SE302Ax10	Offertax10	150,58 €	150,58 €	10	1
SE302Ax15	Offertax15	136,75 €	136,75 €	15	1



Scaldabagno Bandini Braun
Vetroporcellnatao Vert. 30 Lt
B/30 2 Anni Garanzia



Codice	Riferimenti	Listino A	Listino B	Off.	Box
B302A		175,96 €	195,31 €	1	1
B302Ax5	Offertax5	167,58 €	186,01 €	5	1
B302Ax10	Offertax10	155,01 €	172,06 €	10	1
B302Ax15	Offertax15	140,77 €	156,25 €	15	1



Scaldabagno Bandini Braun
Vetroporcellnatao Vert. 50 Lt 2
Anni Garanzia



Codice	Riferimenti	Listino A	Listino B	Off.	Box
SE502A		173,45 €	173,45 €	1	1
SE502Ax5	Offertax5	165,19 €	165,19 €	5	1
SE502Ax10	Offertax10	152,80 €	152,80 €	10	1
SE502Ax15	Offertax15	138,76 €	138,76 €	15	1



Scaldabagno Bandini Braun
Vetroporcellnatao Oriz. 50 Lt 2
Anni Garanzia Sx



Codice	Riferimenti	Listino A	Listino B	Off.	Box
SO502ASX		226,23 €	251,12 €	1	1
SO502ASXx5	Offertax5	215,46 €	239,16 €	5	1
SO502ASXx10	Offertax10	199,30 €	221,22 €	10	1
SO502ASXx15	Offertax15	180,99 €	200,89 €	15	1



Scaldabagno Bandini Braun
Vetroporcellnatao Vert. 80 Lt 2
Anni Garanzia

PROMO



Codice	Riferimenti	Listino A	Listino B	Off.	Box
SE802A		201,10 €	201,10 €	1	1
SE802Ax5	Offertax5	191,52 €	191,52 €	5	1
SE802Ax10	Offertax10	177,16 €	177,16 €	10	1
SE802Ax15	Offertax15	160,88 €	160,88 €	15	1



Scaldabagno Bandini Braun
Vetroporcellnatao Oriz. 80 Lt 2
Anni Garanzia Sx



Codice	Riferimenti	Listino A	Listino B	Off.	Box
SO802ASX		241,32 €	241,32 €	1	1
SO802ASXx5	Offertax5	229,82 €	229,82 €	5	1
SO802ASXx10	Offertax10	212,59 €	212,59 €	10	1
SO802ASXx15	Offertax15	193,05 €	193,05 €	15	1

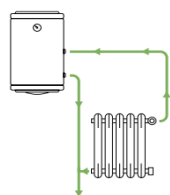

Scaldabagno Bandini Braun
Termoelettrico Lt 80 Vert. 2
Anni Garanzia Dx



Codice	Riferimenti	Listino A	Listino B	Off.	Box
ST802ADX	80 LT Dx	275,93 €	306,29 €	1	1
ST802ASX	80 LT Sx	275,93 €	306,29 €	1	1



Scaldabagno Bandini a Legna
Elettrico 80 Lt 2 Anni Garanzia



Codice	Riferimenti	Listino A	Listino B	Off.	Box
SX0080C2V	80 LT	532,00 €	590,52 €	1	1



Chiave Per Codoli Radiatore
Da 3/8" A 1"

Codice	Riferimenti	Listino A	Listino B	Off.	Box
CPCRM		30,36 €	33,70 €	1	10



Aspiratore da Muro ultra sottile
APB101 4" 15*15 15W QTA/036



Codice	Riferimenti	Listino A	Listino B	Off.	Box
APB101		17,07 €	18,95 €	1	10



Aspiratore da Muro 11a - 12
tubo D. 120 240 M/H 34 DB 19
W

Aspiratore da Muro 13a - 15
tubo D. 150 20 M/H 34 DB 28 W

Codice	Riferimenti	Listino A	Listino B	Off.	Box
8432011617700	D. 120	21,92 €	24,33 €	1	10
8432011617694	D. 150	24,32 €	26,99 €	1	10



Supporto Scaldino 8X70 Tas. 10

Supporto Scaldabagno 10X140

Codice	Riferimenti	Listino A	Listino B	Off.	Box
SS100	8X70	0,72 €	0,80 €	1	10
SS140	10X140	1,56 €	1,73 €	1	10



Supporto Sanitari Laterale
Multiforo

Codice	Riferimenti	Listino A	Listino B	Off.	Box
SSL		3,87 €	4,29 €	1	10



Sil 3004 Trasparente Antim.

Codice	Riferimenti	Listino A	Listino B	Off.	Box
TSTP	Trasparente	3,40 €	3,77 €	1	30
TSTPx30	Offertax30	3,30 €	3,66 €	30	30
TSTPx60	Offertax60	3,23 €	3,59 €	60	30
TSTPx120	Offertax120	3,16 €	3,51 €	120	30



Pressatrice Manuale Profes.

Codice	Riferimenti	Listino A	Listino B	Off.	Box
PS000003		250,49 €	278,04 €	1	10



Pressatrice Professionale A
Batteria Per Raccordi Tubi
Multistrato Completa Di Inserti
D. 16-20-26 Mm Con Profilo Th

Codice	Riferimenti	Listino A	Listino B	Off.	Box
PS000004		1262,56 €	1401,45 €	1	10



Giratubo Izeltas 11/2" 90°
Giratubo Izeltas T/Dowidat 2"
Giratubo Professional 45° D. 1"
Giratubo Professional 45° D. 11/2"

Codice	Riferimenti	Listino A	Listino B	Off.	Box
G11\2I90	D. 1" 90°	40,58 €	45,05 €	1	10
G2I90	D. 2" 90°	59,28 €	65,80 €	1	10
GE145	D. 1" 45°	18,72 €	20,78 €	1	10
GE11\245	D. 11/2" 45°	28,70 €	31,86 €	1	10



Supporto Per Lavabo 100X10
Tassello D.12



Supporto Per Lavabo 140X10
Tassello D.14

Supporto Per Lavabo 180X10
Tassello D.14

Codice	Riferimenti	Listino A	Listino B	Off.	Box
SL120	120x10	1,08 €	1,20 €	1	10
SL140	140x10	1,57 €	1,74 €	1	10
SL180	180x10	1,85 €	2,05 €	1	10



Supporto Sanitari Terra 4 Pz

Codice	Riferimenti	Listino A	Listino B	Off.	Box
SST		1,69 €	1,88 €	1	10



Sil 3004 Bianco Antimuffa

Codice	Riferimenti	Listino A	Listino B	Off.	Box
TSBP	Bianco	3,52 €	3,91 €	1	30
TSBPx30	Offertax30	3,41 €	3,79 €	30	30
TSBPx60	Offertax60	3,34 €	3,71 €	60	30
TSBPx120	Offertax120	3,27 €	3,63 €	120	30



Stura Lavandino a Pompa
Con Ventosa Per Tubi
Lavello Lavandini WC
Bagno 79469



Spurgo Biologico



Multimetro Tester Analogico
Portatile Voltmetro
Amperometro Ohmmetro M-
133

Codice	Off.	Listino A	Listino B	Codice	Off.	Listino A	Listino B	Codice	Off.	Listino A	Listino B
79469	1	6,07 €	6,74 €	93060001	1	42,68 €	47,38 €	4073A	1	8,93 €	9,91 €

Pistola Silicone Ec. Lamiera



Pistola Silicone Professionale



Rilevatore Fughe Gas 400
MI

Codice	Off.	Listino A	Listino B	Codice	Off.	Listino A	Listino B	Codice	Off.	Listino A	Listino B
PSE	1	3,81 €	4,23 €	PSP	1	6,61 €	7,34 €	RFG	1	8,61 €	9,55 €
PSEx12	12	2,35 €	2,61 €	PSPx12	12	6,28 €	6,97 €				

Lama Puk Pz 12



Mini Archetto Per
Metallo Con Arco
Orientabile



Kit Per Tubo
Multistrato
1) Cesويا Da 0-32
Mm 1) Calbratore
14-16-18-20-26-
32 Mm



Codice	Off.	Listino A	Listino B	Codice	Off.	Listino A	Listino B	Codice	Off.	Listino A	Listino B
PUK	1	3,41 €	3,78 €	MINIARC01	1	7,41 €	8,22 €	KITCC32	1	12,21 €	13,56 €
PUKx144	144	3,24 €	3,59 €	MINIARC01x6	6	7,04 €	7,81 €	KITCC32x4	4	11,60 €	12,88 €

Cesويا Per Tubi Di
Plastica 0/42 Mm



Cesويا 0/42 Mm



Cesويا 0/36 Mm



Codice	Off.	Listino A	Listino B	Codice	Off.	Listino A	Listino B	Codice	Off.	Listino A	Listino B
PC301	1	7,97 €	8,85 €	PC309	1	15,68 €	17,40 €	PC306	1	27,32 €	30,32 €
PC301x4	4	7,57 €	8,41 €		2	Arrivo	Arrivo	PC306x2	2	25,95 €	28,80 €

Sbavatore
Multistrato
Universo



Calibratore
Svasatore Con
Lame Per Tubo
Multistrato D.
16-20-26 Mm



Disotturatore Tipo
Pango



Codice	Off.	Listino A	Listino B	Codice	Off.	Listino A	Listino B	Codice	Off.	Listino A	Listino B
SMQ	1	3,64 €	4,04 €	DCAL1626P	1	9,79 €	10,87 €	DPAC02	1	20,04 €	22,24 €



Forno Casetta 81X103 Sp.Lat.
Kg. 6 X Uso Domestico



Codice	Riferimenti	Listino A	Listino B	Conf.	Box
HS210		1181,35 €	1181,35 €	1	10

Campingaz Barbecue Carbone BONESCO



Large Nero

Barbecue Campingaz Bonesco
Qst L. Carrello Antracite Nero



Codice	Riferimenti	Listino A	Listino B	Conf.	Box
3000001554		269,36 €	298,99 €	1	10



CAMPINGAZ Barbecue a Gas Piastra in Ghisa da Esterno BBQ da Giardino con Ripiani laterali Ruote e Vano portabombola - 3000004975 Adelaide 3 Woody



Codice	Riferimenti	Listino A	Listino B	Conf.	Box
203431		295,52 €	328,03 €	1	10



Barbecue A Carbonella Ferraboli
Pic Nic 28 Cm

Codice	Riferimenti	Listino A	Listino B	Conf.	Box
0000208		31,37 €	34,82 €	1	10



Powerbox 24 Cl-A Te Cooler



Codice	Riferimenti	Listino A	Listino B	Conf.	Box
68679		86,21 €	95,69 €	1	10



Lume A Gas Camping 206 L

Codice	Riferimenti	Listino A	Listino B	Conf.	Box
2000010189		27,07 €	30,05 €	1	10



Cartuccia Cp 250 Nuovo
Cod.2000022384
Cod. 2000034449

Codice	Riferimenti	Listino A	Listino B	Conf.	Box
202208		3,99 €	4,43 €	1	10



Forno Retto 81X103 Spor.Lat.
Kg. 6 X Uso Domestico



Codice	Riferimenti	Listino A	Listino B	Conf.	Box
HS100		1181,35 €	1181,35 €	1	10



Barbecue Campingaz Bonesco Kettle
Antracite Nero, Grigio



Codice	Riferimenti	Listino A	Listino B	Conf.	Box
3000001552		162,33 €	180,19 €	1	10



Barbecue Compatto A Gas Con Due Bruciatori



Codice	Riferimenti	Listino A	Listino B	Conf.	Box
3000002865		126,27 €	140,16 €	1	10



Ferraboli Ledro Grill Carrello
Antracite Nero 65 X 48 X 84

Codice	Riferimenti	Listino A	Listino B	Conf.	Box
0000149		55,77 €	61,90 €	1	10



Barbecue a carbonella 30 X 45
con base/ruote e appoggio

Codice	Riferimenti	Listino A	Listino B	Conf.	Box
1068		65,06 €	72,22 €	1	10



Cannello Brevettato corpo
plastica con piezo

Codice	Riferimenti	Listino A	Listino B	Conf.	Box
CPEH		16,90 €	18,76 €	1	10



Cv 300 Plus - Cartuccia
3000005010

Codice	Riferimenti	Listino A	Listino B	Conf.	Box
203427		6,77 €	7,51 €	1	10



Set 10 Fascette Per Tubi

2x8 -18mm
2x11-20mm
2x13-23mm
2x18-25mm
2x14-27mm

Codice	Riferimenti	Listino A	Listino B	Conf.	Box
770308		1,24 €	1,37 €	1	10



Cartuccia Gas Da 190 Gr.



Codice	Riferimenti	Listino A	Listino B	Conf.	Box
CG190		1,71 €	1,90 €	1	10



Set 6 Fascette Per Tubi

Codice	Riferimenti	Listino A	Listino B	Conf.	Box
748310		0,91 €	1,01 €	1	10



Chiave Bombola Da 25

Codice	Riferimenti	Listino A	Listino B	Conf.	Box
CB25		1,67 €	1,85 €	1	10



Fornellone Piccolo

bruciatore da 12,5cm
30x30cm

Codice	Riferimenti	Listino A	Listino B	Conf.	Box
792600		22,25 €	24,70 €	1	10



Fornellone Grande

bruciatore da 17,5cm
40x40CM

Codice	Riferimenti	Listino A	Listino B	Conf.	Box
792601		29,67 €	32,94 €	1	10



Fornellone Cm 30X30X13 Con Bruciatore In Ghisa Kw 3,5 Omologato Ce

Codice	Riferimenti	Listino A	Listino B	Conf.	Box
600CE		29,64 €	32,90 €	1	10



Fornellone Cm 40X40X19 Con Bruciatore In Ghisa Kw 8,5 Omologato Ce

Codice	Riferimenti	Listino A	Listino B	Conf.	Box
230CE		41,66 €	46,24 €	1	10



Girella 3 Bracci Orientabili

Codice	Riferimenti	Listino A	Listino B	Conf.	Box
33425001		12,12 €	13,45 €	1	10



Fornello Cm 30X30X13 Con Telaio, Viteria E Regolatore Aria In Acciaio Inox Aisi 430. Bruciatore In Ghisa Kw 3,5. Omologato Ce.

Codice	Riferimenti	Listino A	Listino B	Conf.	Box
650CE		34,72 €	38,54 €	1	10



Giunto Riparatore 1/2"-5 /8

Codice	Riferimenti	Listino A	Listino B	Conf.	Box
33320001		2,73 €	3,03 €	1	10



Fornellone "Mammuth" Cm. 38 X 38 X 19H Fornellone Pesante Con Bruciatore In Ghisa Da Kw 8,5. Omologato Ce.

Codice	Riferimenti	Listino A	Listino B	Conf.	Box
150CE		51,07 €	56,68 €	1	10



Giunto Riparatore 5 /8-3/4"

Codice	Riferimenti	Listino A	Listino B	Conf.	Box
33325001		3,19 €	3,54 €	1	10



Giunto Ripar. Uni. 1/2"-5 /8-3/4"

Codice	Riferimenti	Listino A	Listino B	Conf.	Box
33330001		4,00 €	4,44 €	1	10



Ala Gocciolante Ø16Mm 2 Lt/H
30Cm 100M

Codice	Riferimenti	Listino A	Listino B	Conf.	Box
431160230100		0,42 €	0,47 €	1	10



Gomito Per Ala Con Anellino Ø
16

Codice	Riferimenti	Listino A	Listino B	Conf.	Box
9980016000		0,51 €	0,57 €	1	10



Manicotto Ala

Codice	Riferimenti	Listino A	Listino B	Conf.	Box
MAALA		0,49 €	0,55 €	1	10



Raccordo Maschio Per Ala Con
Anellino Ø 16X1/2

Codice	Riferimenti	Listino A	Listino B	Conf.	Box
991401600B		0,36 €	0,40 €	1	10



Raccordo Maschio Per Ala Con
Anellino Ø 16X3/4

Codice	Riferimenti	Listino A	Listino B	Conf.	Box
991401600C		0,36 €	0,40 €	1	10



Tee Per Ala Con Anellino Ø 16

Codice	Riferimenti	Listino A	Listino B	Conf.	Box
9950016000		0,61 €	0,68 €	1	10



Raccordo Per Tubi 1/2"

Codice	Riferimenti	Listino A	Listino B	Conf.	Box
515235		0,66 €	0,73 €	1	10



Lancia Erogatrice

Codice	Riferimenti	Listino A	Listino B	Conf.	Box
770360		1,29 €	1,44 €	1	10



Lancia Erogatrice

Codice	Riferimenti	Listino A	Listino B	Conf.	Box
770283		1,68 €	1,87 €	1	10



Pistola Da Giardino 9 Getti

Codice	Riferimenti	Listino A	Listino B	Conf.	Box
538210		8,94 €	9,93 €	1	10



Pistola Erogatore Per Tubo Da

Codice	Riferimenti	Listino A	Listino B	Conf.	Box
770281		3,63 €	4,02 €	1	10



Pistola Erogatore Per Tubo Da

Codice	Riferimenti	Listino A	Listino B	Conf.	Box
770282		4,15 €	4,61 €	1	10



Pistola Erogatrice

Codice	Riferimenti	Listino A	Listino B	Conf.	Box
770358		9,78 €	10,85 €	1	10



Raccordo Per Tubi 3/4"

Codice	Riferimenti	Listino A	Listino B	Conf.	Box
515236		0,91 €	1,01 €	1	10



Raccordo 1/2"-5/8" Fermo Sicu.

Codice	Riferimenti	Listino A	Listino B	Conf.	Box
33305001		4,91 €	5,45 €	1	10



Raccordo 1/2"-5/8-3/4" Fermo

Codice	Riferimenti	Listino A	Listino B	Conf.	Box
33315001		4,55 €	5,06 €	1	10



Raccordo 5/8-3/4" Fermo Sic.

Codice	Riferimenti	Listino A	Listino B	Conf.	Box
33310001		4,38 €	4,86 €	1	10



Tubo Garden 6 Strati 3/4" Mt. 25

Codice	Riferimenti	Listino A	Listino B	Conf.	Box
33040001		67,56 €	74,99 €	1	10



Avvolgitubo C/Stand

Codice	Riferimenti	Listino A	Listino B	Conf.	Box
538206		31,43 €	34,88 €	1	10



Tubo Garden 6 Strati 1/2" Mt. 15

Codice	Riferimenti	Listino A	Listino B	Conf.	Box
33010001		20,57 €	22,83 €	1	10



Doccia Da Giardino C/Base 2,25 Mt

Codice	Riferimenti	Listino A	Listino B	Conf.	Box
538201		20,67 €	22,95 €	1	10



Tubo Garden 6 Strati 1/2" Mt. 25

Codice	Riferimenti	Listino A	Listino B	Conf.	Box
33015001		34,33 €	38,11 €	1	10



Irrigatore Multifunzione

Codice	Riferimenti	Listino A	Listino B	Conf.	Box
770316		4,83 €	5,36 €	1	10



Irrigatore Rotante

Codice	Riferimenti	Listino A	Listino B	Conf.	Box
770315		4,20 €	4,66 €	1	10



Irrigatore X Giardino A Settore

Codice	Riferimenti	Listino A	Listino B	Conf.	Box
516892		5,69 €	6,32 €	1	10



Irrigatore X Giardino A Settore

Codice	Riferimenti	Listino A	Listino B	Conf.	Box
516890		3,96 €	4,40 €	1	10



Irrigatore X Giardino Rot.

Codice	Riferimenti	Listino A	Listino B	Conf.	Box
516891		2,86 €	3,17 €	1	10



Lancia C/Getto Regolabile

Codice	Riferimenti	Listino A	Listino B	Conf.	Box
770363		7,64 €	8,48 €	1	10

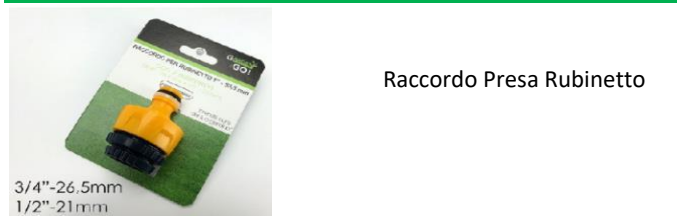

Raccordo Presa Rubinetto

3/4"-26,5mm
1/2"-21mm

Codice	Riferimenti	Listino A	Listino B	Conf.	Box
770355		1,24 €	1,37 €	1	10



Raccordo Presa Rubinetto

3/4"-26,5mm
1/2"-21mm

Codice	Riferimenti	Listino A	Listino B	Conf.	Box
770357		3,39 €	3,76 €	1	10



Raccordo Presa Rubinetto 2 Vie

Codice	Riferimenti	Listino A	Listino B	Conf.	Box
515238		0,96 €	1,07 €	1	10



Raccordo Rapido

1/2" - 13MM

Codice	Riferimenti	Listino A	Listino B	Conf.	Box
770354		1,24 €	1,37 €	1	10



Raccordo Rapido A Innesto 1/2"

1/2" - 13MM

Codice	Riferimenti	Listino A	Listino B	Conf.	Box
515237		1,24 €	1,38 €	1	10



Raccordo Rapido Acqua Stop

1/2" - 13MM

Codice	Riferimenti	Listino A	Listino B	Conf.	Box
770354A		1,24 €	1,37 €	1	10



Raccordo Rapido Acqua Stop
1/2"

CON ACQUA STOP
per tubo da 1/2" - 13mm

Codice	Riferimenti	Listino A	Listino B	Conf.	Box
515237A		1,24 €	1,38 €	1	10



Raccordo Rubinetto 3/4" - 1/2"

3/4"-26,5mm
1/2"-21mm

Codice	Riferimenti	Listino A	Listino B	Conf.	Box
515234		1,11 €	1,24 €	1	10



Seghetto C/2

Lame 16 Cm

Codice	Riferimenti	Listino A	Listino B	Conf.	Box
770147		5,53 €	6,14 €	1	10



Set 3 Pz Giardinaggio

21cm

Codice	Riferimenti	Listino A	Listino B	Conf.	Box
747849		2,04 €	2,27 €	1	10



Set 3 Pz Giardinaggio
Man.Verde

25cm

Codice	Riferimenti	Listino A	Listino B	Conf.	Box
747850		2,04 €	2,27 €	1	10



Set 3 Raccordi C/Erogatore Per

Codice	Riferimenti	Listino A	Listino B	Conf.	Box
770280		2,73 €	3,03 €	1	10



Pistola A Lancia Volume Var.

Codice	Riferimenti	Listino A	Listino B	Conf.	Box
33405001		14,25 €	15,81 €	1	10



Racc.5/8-3/4 Fermo Acqua Stop

Codice	Riferimenti	Listino A	Listino B	Conf.	Box
33310102		5,67 €	6,29 €	1	10



Giunto Riparatore 5 /8-3/4"

Codice	Riferimenti	Listino A	Listino B	Conf.	Box
33325001		3,19 €	3,54 €	1	10



Irrigatore 360°Turbina Slit.

Codice	Riferimenti	Listino A	Listino B	Conf.	Box
33430001		27,05 €	30,02 €	1	10



Irrigatore 9 Figure C/Pop Up

Codice	Riferimenti	Listino A	Listino B	Conf.	Box
33420001		17,76 €	19,72 €	1	10



Tubo Estensibile 15 Mt C/Pistola
7

Codice	Riferimenti	Listino A	Listino B	Conf.	Box
538219		24,76 €	27,48 €	1	10



Tubo Giallo 20 Mt Da Giardino

Codice	Riferimenti	Listino A	Listino B	Conf.	Box
805800	10 mt	8,17 €	9,07 €	1	10
805801	15 mt	10,91 €	12,10 €	1	10
805802	20 mt	14,60 €	16,21 €	1	10



Tubo 10 Mt C/Pistola + Acc.

Tubo 15 Mt C/Pistola + Acc.

Tubo 20 Mt C/Pistola+Acc.

Tubo 30 Mt C/Pistola + Acc.

Codice	Riferimenti	Listino A	Listino B	Conf.	Box
692910	10 mt	8,55 €	9,49 €	1	10
692907	15 mt	13,36 €	14,83 €	1	10
692905	20 mt	17,08 €	18,96 €	1	10
692906	25 mt	22,04 €	24,46 €	1	10



Irrigatore 360°Turbina Fisso

33.435.001

Codice	Riferimenti	Listino A	Listino B	Conf.	Box
33435001		21,08 €	23,39 €	1	10



Irrigatore 8 Figure

Codice	Riferimenti	Listino A	Listino B	Conf.	Box
33415001		9,67 €	10,73 €	1	10



Lancia C/Spruo Regolabile Zx

Codice	Riferimenti	Listino A	Listino B	Conf.	Box
33400001		6,71 €	7,44 €	1	10



Tubo Antigelo 14x19 mm rotolo
130 Prezzo al Kg. ogni metro
pesa circa 0,18 kg

Tubo Antigelo 18X24 mm
rotolo 100 Prezzo al Kg. ogni
metro pesa circa 0,23 kg

Codice	Riferimenti	Listino A	Listino B	Conf.	Box
TA14X19		5,44 €	6,04 €	1	10
TA18X24		5,44 €	6,04 €	1	10



Fascetta Stringitubo 14<>18
Prezzo confezione pz. 100
banda 9 mm

Fascetta Stringitubo 20<>32
Prezzo confezione pz. 100
banda 9 mm

Codice	Riferimenti	Listino A	Listino B	Conf.	Box
FS14-18		19,72 €	21,88 €	1	10
FS20-32		24,55 €	27,25 €	1	10



ROBOT RASAERBA HY DM2
vinco

Codice	Riferimenti	Listino A	Listino B	Conf.	Box
65490	Robot	1195,51 €	1327,02 €	1	10

CAVO ALIMENTAZIONE MT 100 PER ROTOT RASAERBA

Codice	Riferimenti	Listino A	Listino B	Conf.	Box
96531	Cavo Mt. 100	107,33 €	119,14 €	1	10

RUOTA ANTERIORE PER ROBOT RASAERBA

Codice	Riferimenti	Listino A	Listino B	Conf.	Box
96542	Ruota anteriore	3,16 €	3,50 €	1	10



	Batavia 7062507 18 V Agli Ioni Di Litio Per Segna A Gattuccio, 36 W 18V LI-ION SEGNA ALTERNATIVA 0-3000 SPM LUNGHEZZA DEL TRATTO 22MM SOLO STRUMENTO		FORBICI A BATTERIA BATAVIA 3,6V - Incl. Teste Di Taglio		COMPRESSORE D'ARIA 18V, Colore: Grigio/Arancione						
Codice	Pz	Listino A	Listino B	Codice	Pz	Listino A	Listino B	Codice	Pz	Listino A	Listino B
7062507	1	104,85 €	116,38 €	7047996	1	42,59 €	47,28 €	7063487	1	92,51 €	102,69 €
	Batavia 18V Batteria Utensile Multifunzione 7062510 Senza Caricabatteria		DECESPUGLIATORE 18 V AGLI IONI DI LITIO BATAVIA		Sega Circolare A Batteria 18V Maxxpack						
Codice	Pz	Listino A	Listino B	Codice	Pz	Listino A	Listino B	Codice	Pz	Listino A	Listino B
7062510	1	60,86 €	67,56 €	7062516	1	84,52 €	93,82 €	7062508	1	109,56 €	121,61 €
	Batavia Bat7062511 Maxxpack 2 Modalità Trapano Sds 18V Nudo Unità		Jig Saw Seghetto Alternativo Bat		Idropulitrice A Batteria, 24 Bar, Senza Batteria/Caricabatterie						
Codice	Pz	Listino A	Listino B	Codice	Pz	Listino A	Listino B	Codice	Pz	Listino A	Listino B
7062511	1	134,11 €	148,86 €	7062513	1	67,88 €	75,35 €	7063576	1	121,73 €	135,12 €
	Motosega Compatta Batavia		Motosega Compatta Batavia Completo Di Batteria E Copribatteria		Scala Telescopica Giraffe Air 3.27M Con Softclose & Antiscivolo						
Codice	Pz	Listino A	Listino B	Codice	Pz	Listino A	Listino B	Codice	Pz	Listino A	Listino B
7063825	1	121,73 €	135,12 €	7063824	1	199,00 €	220,89 €	7063596	1	219,11 €	243,21 €
	Trapano Combinato Con Motore Senza Spazzole Batavia		Pompa Da Giardino 1500 L/H 11 M - Batavia		COMPRESSORE D'ARIA 18V, Colore: Grigio/Arancione						
Codice	Pz	Listino A	Listino B	Codice	Pz	Listino A	Listino B	Codice	Pz	Listino A	Listino B
7062722	1	219,13 €	243,24 €	7063549	1	109,49 €	121,53 €	7063487	1	92,51 €	102,69 €
	BATTERIA AGLI IONI DI LITIO 36W 18V 4 AH		Giraffe Air Telescopipladder 2,63M 7063650 Batavia		Scala Telescopica In Alluminio, Altezza Di Lavoro (Max): 4,6 M, 3 Colori, 15,3 Kg						
Codice	Pz	Listino A	Listino B	Codice	Pz	Listino A	Listino B	Codice	Pz	Listino A	Listino B
7062518	1	77,46 €	85,98 €	7063650	1	170,43 €	189,18 €	7063088	1	304,34 €	337,82 €
	SCALA A SFILLO IN ACCIAIO GR. 4+4		SCALA A SFILLO IN ACCIAIO GR. 4+5		SCALA A SFILLO IN ACCIAIO GR. 5+5						
Codice	Pz	Listino A	Listino B	Codice	Pz	Listino A	Listino B	Codice	Pz	Listino A	Listino B
PRATIC4+4ACC	1	112,81 €	125,22 €	PRATIC4+5ACC	1	127,38 €	141,39 €	PRATIC5+5ACC	1	143,28 €	159,04 €



	SCALA LIBELLULA 4 GRADINI		SCALA LIBELLULA 5 GRADINI		SCALA LIBELLULA 6 GRADINI						
Codice S107A04W	Pz 1	Listino A 60,76 €	Listino B 67,45 €	Codice S107A05W	Pz 1	Listino A 71,94 €	Listino B 79,85 €	Codice S107A06W	Pz 1	Listino A 84,07 €	Listino B 93,32 €
	SCALA LIBELLULA 7 GRADINI		SCALA LIBELLULA 8 GRADINI		SGABELLO STABILE 2 GRADINI						
Codice S107A07W	Pz 1	Listino A 105,40 €	Listino B 116,99 €	Codice S107A08W	Pz 1	Listino A 120,88 €	Listino B 134,17 €	Codice G120L02W	Pz 1	Listino A 31,79 €	Listino B 35,28 €
	Cazzuola Pt 18 Progrip		Cazzuolino Foglio Olivo Cm.14		SGABELLO STABILE 3 GRADINI						
Codice 123601	Pz 1	Listino A 8,32 €	Listino B 9,24 €	Codice 123473	Pz 1	Listino A 4,53 €	Listino B 5,03 €	Codice G120L03W	Pz 1	Listino A 41,73 €	Listino B 46,32 €
	Cazzuola P.T. 19.1 Ghiera		Cazzuolino Foglio Ulivo Cm.14 Expo		Martellina Catania Gr.400						
Codice 123341	Pz 1	Listino A 7,51 €	Listino B 8,34 €	Codice 3062A	Pz 1	Listino A 2,83 €	Listino B 3,15 €	Codice 110820	Pz 1	Listino A 7,29 €	Listino B 8,09 €
	Metro Avvolgibile Mt. 2		Martello Carpentiere Gr. 300 In Fibbra Expo		Martello Carpentiere Gr. 300 Faggio Expo						
Codice 748082	Pz 1	Listino A 0,86 €	Listino B 0,95 €	Codice 3004B	Pz 1	Listino A 8,10 €	Listino B 8,99 €	Codice 3004A	Pz 1	Listino A 5,47 €	Listino B 6,07 €
	Mazzetta Club C/M Gr. 1000		Mazzetta Master Gr.1000 Progrip		Set 5 Giraviti Unior - 4,01 5,5X1,25 6,5X 150 + 1X80						
Codice 10145	Pz 1	Listino A 12,71 €	Listino B 14,10 €	Codice 10143	Pz 1	Listino A 15,26 €	Listino B 16,94 €	Codice 609CS5BI	Pz 1	Listino A 17,43 €	Listino B 19,35 €
	Imbuto Flessibile Con Filtro		Tubo Per Travaso		Pinza Manici Super Grip Da 200						
Codice 749103	Pz 1	Listino A 1,37 €	Listino B 1,52 €	Codice 749104	Pz 1	Listino A 1,24 €	Listino B 1,38 €	Codice 406BI	Pz 1	Listino A 10,36 €	Listino B 11,50 €



	Ardes Stufa Quarzo 800W		Ardes Termoventilatore Baleno Swing Doppia Potenza 1000/2000W		Ardes Termoventilatore Caldobagno Ip21
--	----------------------------	--	---	--	--

Codice	Pz	Listino A	Listino B	Codice	Pz	Listino A	Listino B	Codice	Pz	Listino A	Listino B
AR435B	1	15,57 €	17,28 €	AR4F03	1	31,39 €	34,85 €	AR4F06T	1	53,63 €	59,53 €

	Ardes Tikappa Scaldaletto Matrimoniale 2 Temperatura 160X140		Scaldaletto Singolo 150X80Cm		Ardes Termoventilatore Ceramico 1500 W Ar4P07W
--	--	--	---------------------------------	--	---

Codice	Pz	Listino A	Listino B	Codice	Pz	Listino A	Listino B	Codice	Pz	Listino A	Listino B
AR4U140	1	52,91 €	58,73 €	AR4U80	1	31,26 €	34,70 €	AR4P07A	1	26,81 €	29,76 €

	Scaldaletto Matrimoniale Misto Lana 150X160Cm		Scaldaletto Singolo Misto Lana 150X80Cm		Radiatore 9 Elementi "Kompact" Compatto
--	--	--	---	--	--

Codice	Pz	Listino A	Listino B	Codice	Pz	Listino A	Listino B	Codice	Pz	Listino A	Listino B
AR423	1	92,60 €	102,78 €	AR412	1	55,31 €	61,40 €	S719	1	28,35 €	31,47 €

	Scaldapiedi Con Rivestimento Removibile		Sole Mio Scaldino Elettrico 550W Con Lampada Spia, Bronzo		Stufa a fungo per esterni bianca
--	---	--	--	--	-------------------------------------

Codice	Pz	Listino A	Listino B	Codice	Pz	Listino A	Listino B	Codice	Pz	Listino A	Listino B
AR4H05	1	52,39 €	58,16 €	AR71	1	31,39 €	34,85 €	PGU2013W	1	276,98 €	307,45 €

	Stufa a gas 4.2 kW Grigia		Stufa a gas 4.2 kW Nera		Stufa a fungo per esterni nera
--	------------------------------	--	----------------------------	--	-----------------------------------

Codice	Pz	Listino A	Listino B	Codice	Pz	Listino A	Listino B	Codice	Pz	Listino A	Listino B
GH3042R	1	191,00 €	212,01 €	GH1142R	1	130,38 €	144,72 €	PGU2013B	1	276,98 €	307,45 €

	Stufa Al Quarzo 2 Elementi 800W		Stufa Alogena Con 3 Elementi Riscaldanti, Nera		Stufa Elettrica Alogena Al Quarzo Potenza 800 Watt
--	------------------------------------	--	--	--	--

Codice	Pz	Listino A	Listino B	Codice	Pz	Listino A	Listino B	Codice	Pz	Listino A	Listino B
QZ800	1	11,62 €	12,90 €	AR454B	1	30,85 €	34,25 €	M02543	1	10,82 €	12,01 €

	Termoventilatore Ptc "Warmi" Resistenza Ptc Ardes		Termoventilatore Ceramico Ardes		Termoventilatore Ceramico
--	--	--	------------------------------------	--	------------------------------

Codice	Pz	Listino A	Listino B	Codice	Pz	Listino A	Listino B	Codice	Pz	Listino A	Listino B
S234AEU	1	23,24 €	25,79 €	AR4W02	1	42,80 €	47,51 €	M07170	1	25,39 €	28,18 €



Ventilatore Da Parete Pala 40 Cm. 55 W
Vnco



Codice	Riferimenti	Listino A	Listino B	Conf.	Box
70618	s/telec.	50,93 €	53,99 €	1	10
70619	C/telec.	64,85 €	68,74 €	1	10



Ventilatore da soffitto Vinco – design classico – 55W – diametro pale cm. 107 – 3 velocità – funzione estate/inverno – con lampada da 60W – predisposizione telecomando – colore bianco dettagli oro



Codice	Riferimenti	Listino A	Listino B	Conf.	Box
70912		67,21 €	71,25 €	1	10



Ventilatore a piantana Vinco altezza regolabile fino a cm. 125 – 45W – diametro pale cm. 40 – oscillazione – colore bianco – base a crociera



Codice	Riferimenti	Listino A	Listino B	Conf.	Box
70703E		25,56 €	27,09 €	1	10



Ventilatore da soffitto Vinco – design classico – 55W – diametro pale cm. 107 – 3 velocità – funzione estate/inverno – con lampada da 60W – predisposizione telecomando – colore legno scuro pale bicolore legno scuro/crema

Codice	Riferimenti	Listino A	Listino B	Conf.	Box
70919		61,73 €	65,43 €	1	10



Ventilatore da tavolo Vinco 40W – diametro pale cm. 30 – 3 velocità – oscillazione – colore bianco



Codice	Riferimenti	Listino A	Listino B	Conf.	Box
70601	cm. 30	24,07 €	25,52 €	1	10
70602	cm. 40	29,50 €	31,27 €	1	10



Ventilatore 3 in 1 Vinco Piantana Tavolo Parete: piantana Vinco altezza regolabile fino a cm. 160 – 90W – diametro pale cm. 45 – 3 velocità – oscillazione – parte superiore con supporto per appoggio da tavolo o installazione fissa a parete – colore nero – base tonda



Codice	Riferimenti	Listino A	Listino B	Conf.	Box
70718		48,29 €	51,19 €	1	10



Ventilatore A Piantana Con Umidificatore



Codice	Riferimenti	Listino A	Listino B	Conf.	Box
AR5M39		127,88 €	135,55 €	1	10



vaner - kammerstatorer Con tecnologia A Ultrasuoni, 5 Pale Semi-Trasparenti Diam. 40 Cm, Griglia A Raggiera, Oscillazione Automatica, 3 Velocità, Pannello Di Controllo Digitale Touch, Indicatore Livello Acqua, Timer 7,5H E Telecomando. Umidificatore A



Codice	Riferimenti	Listino A	Listino B	Conf.	Box
AR5M41		161,61 €	171,31 €	1	10



Ventilatore A Piantana 120Cm 3 Pale Semitrasparenti, Motore 45W, Colore Bianco Con Dettagli Grigi



Codice	Riferimenti	Listino A	Listino B	Conf.	Box
TXWZ01		27,88 €	29,56 €	1	10



Ventilatore A Piantana 120Cm 5 Pale Semitrasparenti Blu 45W Colore Nero/Blu



Codice	Riferimenti	Listino A	Listino B	Conf.	Box
TZWZ02PLUS		31,76 €	33,67 €	1	10



Insetticida elettrico orizzontale Vinco da appoggio o sospensione – per interni o esterni – potenza lampade UV 2x10W – cassetto estraibile per pulizia – protegge aree fino a 60 mq. – colore grigio



Codice	Riferimenti	Listino A	Listino B	Conf.	Box
20250		41,75 €	44,25 €	1	10



Insetticida elettrico orizzontale Vinco da appoggio o sospensione – per interni o esterni – potenza lampade UV 2x10W – cassetto estraibile per pulizia – protegge aree fino a 60 mq. – colore grigio



Codice	Riferimenti	Listino A	Listino B	Conf.	Box
20260		48,71 €	51,63 €	1	10



Insetticida elettrico orizzontale Vinco da appoggio o sospensione – per interni o esterni – potenza lampade UV 2x6W – cassetto estraibile per pulizia – protegge aree fino a 30 mq. – colore grigio



Codice	Riferimenti	Listino A	Listino B	Conf.	Box
20230		33,40 €	35,40 €	1	10



Insetticida elettrico orizzontale Vinco da appoggio o sospensione – per interni o esterni – potenza lampade UV 2x8W – cassetto estraibile per pulizia – protegge aree fino a 40 mq. – colore grigio



Codice	Riferimenti	Listino A	Listino B	Conf.	Box
20240		37,43 €	39,68 €	1	10

Mobile comprendente: Mobile 2 Ante cm. 60-80-100, Lavabo, Specchio Reversibile montato su base in legno(senza luce) cm.60X80

Serie Dream con Piedi

Codice	Riferimenti	Off.	Listino A	Listino B
DREAM60APPSI	Signal Mobile Completo	1	283,25 €	283,25 €
DREAM80APPSI	Signal Mobile Completo	1	302,07 €	302,07 €
DREAM100APPSI	Signal Mobile Completo	1	385,30 €	385,30 €
SP60-80	Specchio S/Led	1	67,39 €	67,39 €
SP80-100	Specchio S/Led	1	85,97 €	85,97 €



Mobile comprendente: Mobile 2 Ante cm. 60, Lavabo, Specchio Reversibile montato su base in legno(senza luce) cm. 60X80

Serie Dream Con Sospeso

Codice	Riferimenti	Off.	Listino A	Listino B
DREAM60SI	Signal Mobile Completo	1	247,89 €	247,89 €
DREAM80SI	Signal Mobile Completo	1	271,48 €	271,48 €
SP60-80	Specchio S/Led	1	67,39 €	67,39 €
SP80-100	Specchio S/Led	1	85,97 €	85,97 €



MOBILE EIRENE 2 CASSETTI 60 SOSPEO + LAVABO + Specchio Reversibile montato su base in legno(senza luce) cm. 60X80

Serie Eirene Con Piedi

Codice	Riferimenti	Off.	Listino A	Listino B
EIRENE80APP3CSI	Signal Mobile Completo	1	398,97 €	398,97 €
EIRENE100APP3CSI	Signal Mobile Completo	1	479,21 €	479,21 €
SP60-80	Specchio S/Led	1	67,39 €	67,39 €
SP80-100	Specchio S/Led	1	85,97 €	85,97 €



MOBILE EIRENE 2 CASSETTI 60 SOSPEO + LAVABO + Specchio Reversibile montato su base in legno(senza luce) cm. 60X80

Serie Eirene Sospeso

Codice	Riferimenti	Off.	Listino A	Listino B
EIRENE60SI	Signal Mobile Completo	1	295,08 €	295,08 €
EIRENE80SI	Signal Mobile Completo	1	342,30 €	342,30 €
EIRENE100SI	Signal Mobile Completo	1	385,30 €	385,30 €
SP60-80	Specchio S/Led	1	67,39 €	67,39 €
SP80-100	Specchio S/Led	1	85,97 €	85,97 €



MOBILE bagno: composizione: Lavabo, Completo di 2 mobili cassettoni, Colonna 2 Ante con chiusura soft + Specchio Reversibile montato su base in legno(senza luce) cm. 60X80

MOBILE BAGNO FLY 80

Codice	Riferimenti	Off.	Listino A	Listino B
FLY80SI	Signal Mobile Completo	1	487,97 €	487,97 €



Colonna Dream H. 112 Largo 33 Profondo 30

Colonna 2 Ante chiusura Rallentata, Reversibile apertura sportello DX o Sx

Codice	Riferimenti	Off.	Listino A	Listino B
COLDREAMSI	Signal	1	101,52 €	101,52 €
COLDREAMBT	Bianco Titanio	1	101,52 €	101,52 €
COLDREAMBE	Bengala	1	101,52 €	101,52 €
COLDREAMDV	Dolce Vita	1	101,52 €	101,52 €
COLDREAMOS	Ossido	1	101,52 €	101,52 €
COLDREAMSH	Sherwood	1	101,52 €	101,52 €



Cubo Dream H. 45 Largo 45 Profondo 15

Cubo Dream con Anta apertura Push

Codice	Riferimenti	Off.	Listino A	Listino B
CUBOSI	Signal	1	57,86 €	57,86 €
CUBOBT	Bianco Titanio	1	57,86 €	57,86 €
CUBOBE	Bengala	1	57,86 €	57,86 €
CUBODV	Dolce Vita	1	57,86 €	57,86 €
CUBOOS	Ossido	1	57,86 €	57,86 €
CUBOSH	Sherwood	1	57,86 €	57,86 €



DIAMOND HOME

N.B. Prodotti Su Ordine 10/15 Giorni Lavorazione

Color swatches: Bianco Titanio, Bengala, Dolce Vita, Ossido, Sherwood, Signal

SI	Signal
BT	Bianco Titanio
BE	Bengala
DV	Dolce Vita
OS	Ossido
SH	Sherwood



larghezza sportello cm. 17,5 Altezza Specchio cm. 57, Larghezza dello specchio cm. 80, Profondità cm. 14, Due Luci a led

Specchio da bagno con 2 ante

Codice	Riferimenti	Off.	Listino A	Listino B
SMILE80SI	Signal	1	102,24 €	102,24 €
SMILE80BT	Bianco Titanio	1	102,24 €	102,24 €
SMILE80BE	Bengala	1	102,24 €	102,24 €
SMILE80DV	Dolce Vita	1	102,24 €	102,24 €
SMILE80OS	Ossido	1	102,24 €	102,24 €
SMILE80SH	Sherwood	1	102,24 €	102,24 €



larghezza sportello cm. 17,5 Altezza Specchio cm. 57, Larghezza dello specchio cm. 60, Profondità cm. 14, Due Luci a led

Specchio da bagno con 1 anta

Codice	Riferimenti	Off.	Listino A	Listino B
JOY60SI	Signal	1	90,90 €	90,90 €
JOY60BT	Bianco Titanio	1	89,46 €	89,46 €
JOY60BE	Bengala	1	89,46 €	89,46 €
JOY60DV	Dolce Vita	1	89,46 €	89,46 €
JOY60OS	Ossido	1	89,46 €	89,46 €
JOY60SH	Sherwood	1	89,46 €	89,46 €



11) Colonna Dream Aperta 2 Ripiani

Codice	Riferimenti	Listino A	Listino B
CDA2RSI	Signal	98,68 €	98,68 €

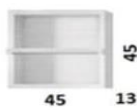

4) Cubo Dream Aperto

Codice	Riferimenti	Listino A	Listino B
CAD1MSI	Signal	53,13 €	53,13 €



1) Colonna Sospesa Slim con Apertura Push Reversibile

Codice	Riferimenti	Listino A	Listino B
CSSP80SI	Signal	103,74 €	103,74 €



2) Mezza Colonna Slim CM. 60 Apertura Dx Su Richiesta Sx

Codice	Riferimenti	Listino A	Listino B
CSSP60DXSI	Signal	101,21 €	101,21 €



8) Mezza Colonna Slim CM. 60 Apertura Dx Su Richiesta Sx

Codice	Riferimenti	Listino A	Listino B
CSP60DXSI	Signal	96,15 €	96,15 €

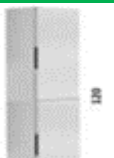

6) Colonna Dream Sospesa 2 Ante Reversibile

Codice	Riferimenti	Listino A	Listino B
CD2ARSI	Signal	116,39 €	116,39 €



Modello Sigma- Specchio Argentato Senza Rame da 5 mm - Sensore Touch per Accensione-Struttura in Alluminio-Luce 6000 K-230V / 50 hz

Codice	Rif.	Listino A	Listino B
SIGMA60	60	156,87 €	156,87 €
SIGMA70	70	179,64 €	179,64 €
SIGMA80	80	156,87 €	156,87 €



Modello Delta- Specchio Argentato Senza Rame da 5 mm - Sensore Touch per Accensione-Struttura in Alluminio-Luce 6000 K-230V / 50 hz

Codice	Rif.	Listino A	Listino B
DELTA6080	60x80	165,22 €	165,22 €
DELTA70100	70x100	201,15 €	201,15 €



Modello Beta- Specchio Argentato Senza Rame da 5 mm - Sensore Touch per Accensione-Struttura in Alluminio-Luce 6000 K-230V / 50 hz

Codice	Rif.	Listino A	Listino B
BETA6080	60x80	172,31 €	172,31 €
BETA70100	70x100	197,35 €	197,35 €



5) Colonna Dream Aperta Con Mensola

Codice	Riferimenti	Listino A	Listino B
CDA1RSI	Signal	96,15 €	96,15 €



4M) Cubo Dream Aperto Con Mensola

Codice	Riferimenti	Listino A	Listino B
CADSI	Signal	50,60 €	50,60 €



3) Colonna Sospesa Slim con Apertura Push Reversibile

Codice	Riferimenti	Listino A	Listino B
CSSP60DXSI	Signal	101,21 €	101,21 €



7) Colonna Dream Sospesa CM. 56 1 Anta

Codice	Riferimenti	Listino A	Listino B
CSSP56SI	Signal	101,21 €	101,21 €



9) Base Multiuso con Cassetto più Sportello

Codice	Riferimenti	Listino A	Listino B
BMC56SI	Signal	111,33 €	111,33 €



10) Colonna con piedini Multiuso 2 Sportelli + Cassetto

Codice	Riferimenti	Listino A	Listino B
CD2A1C168SI	Signal	194,82 €	194,82 €



Modello Paint- Specchio Argentato Senza Rame da 5 mm - Sensore Touch per Accensione-Struttura in Alluminio-Luce 6000 K-230V / 50 hz

Codice	Rif.	Listino A	Listino B
PAINT6080	60x80	79,07 €	79,07 €
PAINT70100	70x100	90,71 €	90,71 €



Modello Omega- Specchio Argentato Senza Rame da 5 mm - Sensore Touch per Accensione-Struttura in Alluminio-Luce 6000 K-230V / 50 hz

Codice	Rif.	Listino A	Listino B
OMEGA6080	60x80	169,02 €	169,02 €
OMEGA70100	70x100	193,56 €	193,56 €

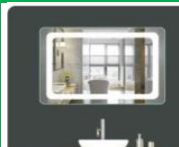

Modello Alfa- Specchio Argentato Senza Rame da 5 mm - Sensore Touch per Accensione-Struttura in Alluminio-Luce 6000 K-230V / 50 hz

Codice	Rif.	Listino A	Listino B
ALFA6080	60x80	176,86 €	176,86 €
ALFA70100	70x100	201,15 €	201,15 €



Lavatoio 80X50 Basic Con Piedini E Strofinatoio In Legno

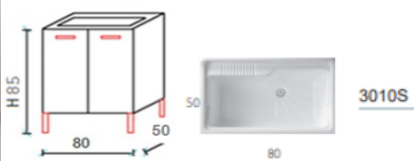

Codice	Riferimenti	Off.	Listino A	Listino B
BB85	Mobile Completo	1	206,80 €	206,80 €
3010S	Vasca Ricambio	1	92,95 €	92,95 €



Lavatoio 60X60 Basic Con Piedini E Strofinatoio In Legno

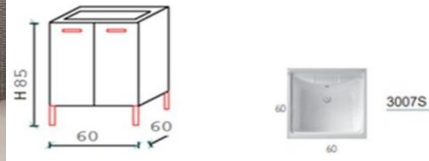

Codice	Riferimenti	Off.	Listino A	Listino B
BB66	Mobile Completo	1	133,96 €	133,96 €
3007S	Vasca Ricambio	1	34,85 €	34,85 €



Lavatoio 50X50 Basic Con Piedini E Strofinatoio In Legno

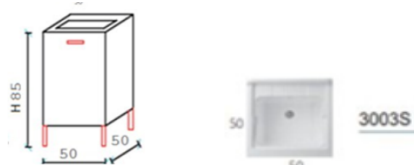

Codice	Riferimenti	Off.	Listino A	Listino B
BB55	Mobile Completo	1	128,73 €	128,73 €
3003S	Vasca Ricambio	1	34,85 €	34,85 €



Lavatoio 60X50 Basic Con Piedini E Strofinatoio In Legno

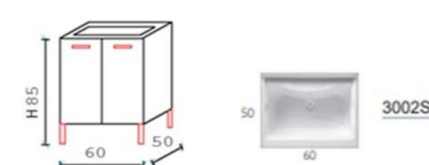

Codice	Riferimenti	Off.	Listino A	Listino B
BB65	Mobile Completo	1	131,36 €	131,36 €
3002S	Vasca Ricambio	1	34,85 €	34,85 €



Lavatoio 45X50 Basic Con Piedini E Strofinatoio In Legno

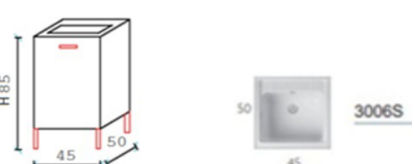

Codice	Riferimenti	Off.	Listino A	Listino B
BB54	Mobile Completo	1	127,68 €	127,68 €
3006S	Vasca Ricambio	1	34,85 €	34,85 €



Lavatoio 45X60 Basic Con Piedini E Strofinatoio In Legno

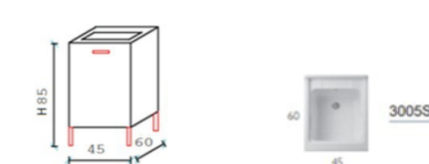

Codice	Riferimenti	Off.	Listino A	Listino B
BB64	Mobile Completo	1	164,51 €	164,51 €
3005S	Vasca Ricambio	1	69,71 €	69,71 €

Coprilavatrice

Codice	Linea Coprilavatrice	Riferimenti	Pz	Listino A	Listino B
CL64D	Lav. Dx	60X109XH90	1	229,88 €	229,88 €
CL64S	Lav. Sx	60X109XH90	1	229,88 €	229,88 €
CL66D	Lav. Dx	60X109XH90	1	243,98 €	243,98 €
CL66S	Lav. Sx	60X109XH90	1	243,98 €	243,98 €



Mobile Portalavatrice, in nobilitato classe E1 da 1,8 bordo colle poliuretaniche, vasca ABS completo di sifone.



TUTTI I MOBILI SONO REALIZZATI IN NOBILITATO SP.18MM.
 - VASCHE IN GRANITO RESISTENTI AGLI ACIDI, DUREVOLI NEL TEMPO.

LAVATOIO



Codice	Riferimenti	Pz	Listino A	Listino B
EL70	70-50 H83	1	386,72 €	386,72 €
EL60	60-50 H83	1	365,95 €	365,95 €
EL50	50-50 H83	1	359,42 €	359,42 €

Mobile completo di vasca in granito
 colori a scelta

COLORI VASCHE GRANITO DISPONIBILI



BIANCO

SAND

NERO BRILLANTATO

FINITURE DEI MOBILI DISPONIBILI





BIANCO LUCIDO

ROVER SBIANCATO

FRASSINO MOIORE

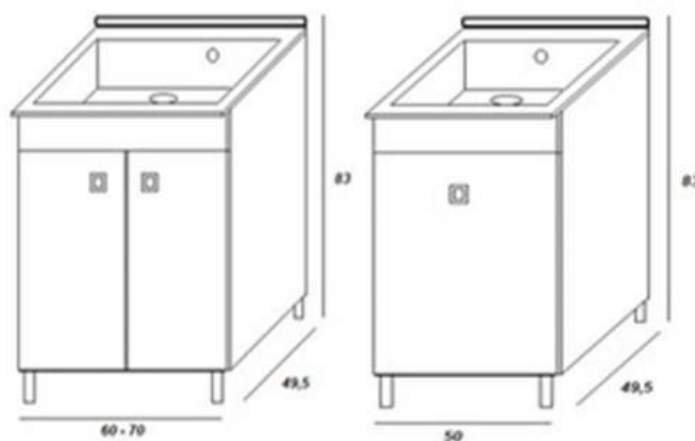
ROVER WELL



85 cm
ALTEZZA
PROFONDITA' Z 50 cm
LARGHEZZA Y 45 cm

Lavatoio Pvc C/Sport. 45X50



50
45

Esterni

Codice	Riferimenti	Off.	Listino A	Listino B
9006K		1	99,74 €	99,74 €



85 cm
ALTEZZA
PROFONDITA' Z 50 cm
LARGHEZZA Y 50 cm

Lavatoio Pvc C/Sport. 50X50



50
50

Esterni

Codice	Riferimenti	Off.	Listino A	Listino B
9003K		1	99,74 €	99,74 €



85 cm
ALTEZZA
PROFONDITA' Z 60 cm
LARGHEZZA Y 60 cm

Lavatoio Pvc C/Sport. 60X60



60
60

Esterni

Codice	Riferimenti	Off.	Listino A	Listino B
9007K		1	124,67 €	124,67 €



85 cm
ALTEZZA
PROFONDITA' Z 50 cm
LARGHEZZA Y 60 cm

Lavatoio Pvc C/Sport. 60X50



50
60

Esterni

Codice	Riferimenti	Off.	Listino A	Listino B
9002K		1	112,21 €	112,21 €

Sottolavelli Con Cassetti 120X50
Bianco Cassettiera Sx Lavello Inox 120



Codice	Riferimenti	Off.	Listino A	Listino B
CL120CBSX	CM. 120 Gocciolatoio SX	1	257,23 €	257,23 €

Sottolavelli Con Cassetti 120X50
Bianco Cassettiera Dx Lavello Inox 120



Codice	Riferimenti	Off.	Listino A	Listino B
CL120CBDX	CM. 120 Gocciolatoio DX	1	257,23 €	257,23 €

Sottolavelli Con Cassetti 120X50
Teck Cassettiera Dx Lavello Inox 120



Codice	Riferimenti	Off.	Listino A	Listino B
CL120CTDX	CM. 120 Gocciolatoio DX	1	257,23 €	257,23 €

Sottolavelli Con Cassetti 120X50
Teck Cassettiera Sx Lavello Inox 120



Codice	Riferimenti	Off.	Listino A	Listino B
CL120CTSX	CM. 120 Gocciolatoio SX	1	257,23 €	257,23 €

Kit Sottolavello 80X50 Teck Con Cassetti Sx Lavello Inox 80X50 1 Vasche Piu' G. Sx Bt5Ls+Pi801Lpc



81
80/90
47,5

Codice	Riferimenti	Off.	Listino A	Listino B
CL80CTLS	CM. 80 Gocciolatoio SX	1	220,04 €	220,04 €
CL80CTLD	CM. 80 Gocciolatoio DX	1	220,04 €	220,04 €

Kit Sottolavello 80X50 Bianco Con Cassetti Sx Lavello Inox 80X50 1 Vasche Piu' G. Sx Bb5Ls+Pi801Lpc



81
80/90
47,5

Codice	Riferimenti	Off.	Listino A	Listino B
CL80CBLS	CM. 80 Gocciolatoio SX	1	220,04 €	220,04 €
CL80CBLD	CM. 80 Gocciolatoio DX	1	220,04 €	220,04 €



Sottolavelli 80X50 Bianco
Lavello Inox 80X50 1
Vasche Piu' G. Dx



Codice	Riferimenti	Off.	Listino A	Listino B
CL80BDX		1	186,08 €	186,08 €



Sottolavelli 80X50 Teck
Lavello Inox 80X50 1
Vasche Piu' G. Dx



Codice	Riferimenti	Off.	Listino A	Listino B
CL80TDX		1	186,08 €	186,08 €



Sottolavelli 120X50
Bianco Dx Lavello Inox
120 X50



Codice	Riferimenti	Off.	Listino A	Listino B
CL120BDX		1	238,64 €	238,64 €



Sottolavelli 120X50 Teck
Dx Lavello Inox 120 X50



Codice	Riferimenti	Off.	Listino A	Listino B
CL120TDX		1	238,64 €	238,64 €



Lavello Appoggio 120X50cm
Destra Serie Pisa Prelucido

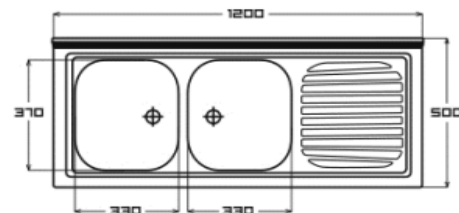

Codice	Codice Apell	Pz	Box	Riferimenti	Listino A	Listino B
PI120RPC	3740001C5	1	5	appoggio 50cm prelucido	117,34 €	117,34 €
PI120LPC	3740201C5	1	5	appoggio 50cm prelucido	117,34 €	117,34 €



Lavello 80X50 1 Vasca Piu
Gocciolatoio Destra - Serie Pisa
Prelucido

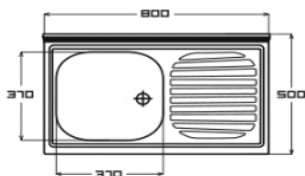

Codice	Riferimenti	Off.	Listino A	Listino B
PI801RPC	3710001C5	5	89,46 €	89,46 €
PI801LPC	3710201C5	5	89,46 €	89,46 €



Lavello Appoggio 80X50 Cm 2
Vasche - Serie Pisa Prelucido

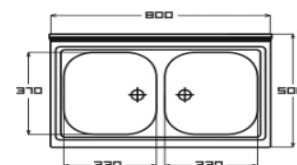

Codice	Riferimenti	Off.	Listino A	Listino B
PI802PC	3750001C5	5	103,40 €	103,40 €



Lavello Inox 86X50 Sx

ht. 19 hv. 17

Altezza Vasca HV 17 Altezza totale HT 19
lavello MOD. Sole

Codice	Riferimenti	Off.	Listino A	Listino B
A186501GSSX		1	63,25 €	70,21 €



Lavello Inox 86X50 Dx

ht. 19 hv. 17

Altezza Vasca HV 17 Altezza totale HT 19
lavello MOD. Sole

Codice	Riferimenti	Off.	Listino A	Listino B
A186501GSDX		1	63,25 €	63,25 €



KIT 4 PZ BOMPANI-APELL: LAVELLO CRITERIA COMPLETO DI ACCESSORI + FORNO 8 F PIANO DA 75 G. GHISA+MIX CANNA ALTA ELLECCI



Gamma Completa

Codice	CRT860IKIT	Codice	BO2430H/E	Codice	BO293MF/N	Codice	MIKC01CR
Codice	Riferimenti	Listino A	Listino B	Codice	Listino A	Listino B	
CRT860IKIT	Lavello Criteria 900 Con Kit Colatoio- Tagliere- Dos.Sapone- Acciaio Inox Spazzolato	292,78 €	324,98 €	K4BF8P75MEC	1231,19 €	1366,62 €	KIT 4 PZ BOMPANI-APELL: LAVELLO CRITERIA COMPLETO DI ACCESSORI + FORNO 8 F PIANO DA 75 G. GHISA+MIX CANNA ALTA ELLECCI
BO2430H/E	Forno Vetro Oscurato E Acciaio Combinato 8 Funzioni	480,18 €	533,00 €				
BO293MF/N	Piano 75 Bo I 5Fv(Tc)Ac5 Inox Front 2007	362,21 €	402,05 €				
MIKC01CR	Mix Ellecci C01 Chrome	89,82 €	99,70 €				

KIT 4 PZ BOMPANI-SOLE: LAVELLO SOLE + FORNO 6 F. PIANO DA 60 FRONTALE +MI Miscelatore Canna Alta



Gamma Completa

Codice	AI86501GSSX	Codice	33703089	Codice	33802764	Codice	MLMDE00
Codice	Riferimenti	Listino A	Listino B	Codice	Listino A	Listino B	
AI86501GSSX	Lavello Inox 86X50 Sx	63,25 €	70,21 €	K4S86BF6P60MCA	508,01 €	563,89 €	KIT 4 PZ BOMPANI-SOLE: LAVELLO SOLE + FORNO 6 F. PIANO DA 60 FRONTALE +MI Miscelatore Canna Alta
33703089	Forno Pop Evo Elettrico, Convection + Fan, 65	255,25 €	283,33 €				
33802764	Piano Cottura Gas Su Metallo	155,74 €	172,87 €				
MLMDE00	Mix Debora Lav. Mon. C /Bassa	29,74 €	29,74 €				

KIT 4 PZ : LAVELLO Avena 116 + FORNO 6 F. PIANO DA 60 FRONTALE +MI Miscelatore Canna Alta Avena



Gamma Completa

Codice	PTPL1162GO	Codice	FCC604NAV	Codice	CHW6BRAV4WGT	Codice	MGKC0151
Codice	Riferimenti	Listino A	Listino B	Codice	Listino A	Listino B	
PTPL1162GO	Lavello 50.116 2V+G Gran.Avena	176,60 €	196,02 €	K4BF8P75ACE	913,00 €	1013,43 €	KIT 4 PZ : LAVELLO Avena 116 + FORNO 6 F. PIANO DA 60 FRONTALE +MI Miscelatore Canna Alta Avena
FCC604NAV	Fcc604Nav Forno Elettrico Da Incasso Ventilato	388,09 €	430,78 €				
CHW6BRAV4WGT	Piano Da 60Cm Avena; Griglie In Piattina; 4	243,66 €	270,46 €				
MGKC0151	Mix Ellecci C01 Avena 51	92,35 €	102,51 €				

KIT 4 PZ SCHOCK-ELLECCI: LAVELLO MASTER + FORNO 5 F. PIANO DA 60 G. CANNA ALTA ELLECCI ESTRAIBILE



Gamma Completa

Codice	LGM50040	Codice	SFN54BKN	Codice	STS64BK	Codice	MGKC0240
Codice	Riferimenti	Listino A	Listino B	Codice	Listino A	Listino B	
LGM50040	Master 500 1160X500 2 Vasche Con Gocciolatoio 40 Nero	250,95 €	278,56 €	K4SF5P60ECE	979,50 €	1087,24 €	KIT 4 PZ SCHOCK-ELLECCI: LAVELLO MASTER + FORNO 5 F. PIANO DA 60 G. CANNA ALTA ELLECCI ESTRAIBILE
SFN54BKN	Forno Schock New England Multifunzione Cm. 60 -	453,11 €	502,95 €				
STS64BK	Piano Cottura Silver Pc 60 Black	197,51 €	219,24 €				
MGKC0240	Miscelatore Cucina Con Doccetta Estraibile	118,92 €	132,00 €				

GRANITEK
ESTETICA PIETRA NATURALE

G68 Bianco Titano
cod. **LGF36068**

G62 Bianco Antico
cod. **LGF36062**

G61 Pietra Antica
cod. **LGF36061**

G59 Antracite
cod. **LGF36059**

G54 Nero
cod. **LGF36054**

G53 Terra
cod. **LGF36053**



G52 Bianco
cod. **LGF36052**

G51 Avena
cod. **LGF36051**

G40 Full Black
cod. **LGF36040**

Gamma Completa

elba
idee in evoluzione

Altri colori Richiedi il Prezzo

Master 500 1160X500 2 Vasche Con Gocciolatoio 51 Avena



Master 400 860X500 Mm 1 Vasca C/Gocciolatoio 51 Avena



Master 450 860X500 Mm 2 Vasche 51 Avena



Codice	Off.	Listino A	Listino B
LGM50051	GTK	250,95 €	278,56 €

Codice	Off.	Listino A	Listino B
LGM40051	1	232,36 €	257,92 €

Codice	Off.	Listino A	Listino B
LGM45051	1	237,01 €	263,08 €

Life 500 1160x500 Mm 2 Vasche C/Gocciolatoio 51 Avena



Living 400 860X500 Mm 1 Vasca C/Gocciolatoio 51 Avena



Life 450 860x500 Mm 2 Vasche 51 Avena



Codice	Off.	Listino A	Listino B
LG250051	GTK	232,36 €	257,92 €

Codice	Off.	Listino A	Listino B
LGL40051	1	193,57 €	214,86 €

Codice	Off.	Listino A	Listino B
LG245051	1	223,07 €	247,61 €

Fox 360 860X500 Mm 1 Vasca 51 Avena



Lavello Laterale Monocomando Avena "Zc"



Mix Elleci S01 Avena 51



Codice	Off.	Listino A	Listino B
LGF36051	GTK	264,90 €	294,03 €

Codice	Off.	Listino A	Listino B
MXB005003AV	1	45,54 €	50,55 €

Codice	Off.	Listino A	Listino B
MGKS0151	1	92,35 €	102,51 €

Lavello Criterias 900 Con Kit Colatoio- Tagliere- Dos.Sapone- Acciaio Inox Spazzolato



Vascone Criterias Acciaio Inox



Mix Elleci C01 Chrome



Codice	Off.	Listino A	Listino B
CRT860IKIT	GTK	292,78 €	324,98 €

Codice	Off.	Listino A	Listino B
CR860I	1	293,94 €	326,27 €

Codice	Off.	Listino A	Listino B
MIKC01CR	1	89,82 €	99,70 €



Serie **ANTARES**

Nuovi modelli prodotti in PVC atossico, igienici e pratici per la pulizia, predisposti di binario con sistema di scorrimento laterale e con chiusura magnetica e attrezzati con sistema di scorrimento a pannelli lamellari anticondensa. Semplice da montare.

MODELLI BOX DOCCIA IN PVC SERIE ANTARES

Ariel/Antares PVC shower box - Ariel/Antares PVC shower box



MODELLI BOX VASCA IN PVC SERIE ANTARES

Ariel/Antares PVC shower for bath - Ariel/Antares PVC shower box for bath

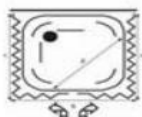

BOX DOCCIA PVC
SERIE "ANTARES"
MOD. VERA

Codice	Riferimenti	Off.	Listino A	Listino B
BOXW70	70X70X70	1	148,11 €	148,11 €
BOXW80	80X80X80	1	156,50 €	156,50 €
BOXW90	90X90X90	1	165,05 €	165,05 €

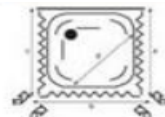

BOX DOCCIA PVC
SERIE "ANTARES"
MOD. MARY

Codice	Riferimenti	Off.	Listino A	Listino B
BOXQ70	70X70X70	1	120,23 €	120,23 €
BOXQ80	80X80X80	1	155,79 €	155,79 €
BOXQ90	90X90X90	1	181,55 €	181,55 €



BOX DOCCIA PVC
SERIE "ANTARES"
MOD. ANTHONY

Codice	Riferimenti	Off.	Listino A	Listino B
BOXU70	80 X 80	1	113,11 €	113,11 €
BOXU70	90 X 90	1	113,11 €	113,11 €
BOXU790	75 X 90	1	124,49 €	124,49 €
BOXU90	90 X 90	1	153,06 €	153,06 €
BOXU100	100 X 100	1	128,76 €	128,76 €



BOX DOCCIA PVC
SERIE "ANTARES"
MOD. ANTHONY

Codice	Riferimenti	Off.	Listino A	Listino B
BOXS80	80 X 80	1	140,14 €	140,14 €
BOXS90	90 X 90	1	147,97 €	147,97 €
BOXX80	80X80 ap. Centr.	1	206,59 €	206,59 €
BOXX90	90X90 ap. Centr.	1	217,86 €	217,86 €



BOX DOCCIA PVC
SERIE "ANTARES"
MOD. ELAN

Codice	Riferimenti	Off.	Listino A	Listino B
BOXE70	70	1	68,29 €	68,29 €
BOXE80	80	1	72,56 €	72,56 €
BOXE90	90	1	77,54 €	77,54 €
BOXE100	100	1	95,79 €	95,79 €
BOXE120	120	1	106,28 €	106,28 €
BOXE140	140	1	118,03 €	118,03 €
BOXE150	150	1	172,15 €	172,15 €
BOXE170	170	1	155,68 €	155,68 €



BOX DOCCIA PVC
SERIE "ANTARES"
MOD. LILLY

Codice	Riferimenti	Off.	Listino A	Listino B
BOXZ70	70 X 70	1	110,34 €	110,34 €
BOXZ80	80 X 80	1	106,35 €	106,35 €
BOXZ790	75 X 90	1	102,44 €	102,44 €
BOXZ90	90 X 90	1	108,09 €	108,09 €
BOXZ100	100 X 100	1	118,09 €	118,09 €
BOXZ8120	80 X 120	1	168,46 €	168,46 €
BOXZ8140	80 X 140	1	182,49 €	182,49 €



Parete Combinabili Singole



Vetro Temperato D. 6 mm

Codice	Riferimenti	Off.	Listino A	Listino B
PBS700218	68<>70 h. 190	1	113,86 €	120,69 €
PBS800218	78<>80 h. 190	1	118,92 €	126,05 €
PBS900218	88<>90 h. 190	1	121,45 €	128,74 €
PBS1000218	98<>100 h. 190	1	123,98 €	131,42 €
PBS1200218	118<>120 h. 190	1	129,04 €	136,78 €
PBS1400218	138<>140 h. 190	1	136,63 €	144,83 €

Componi i lati secondo le tue necessità



Visualizza la gamma completa



Porta Strass
138<>142 Sc.Le Zx
Vetro Satinato Prof.
Cromo



Codice	Riferimenti	Off.	Listino A	Listino B
PS1200218	118<>122	1	240,37 €	254,79 €
PS1400218	138<>142	1	250,49 €	265,52 €



Parete Fissa 73<>77
Prof. Cromo Vetro
Trasparente



Codice	Riferimenti	Off.	Listino A	Listino B
PF700218	68<>72	1	197,66 €	209,52 €
PF750218	73<>77	1	201,15 €	213,22 €
PF800218	78<>82	1	210,41 €	223,04 €



Porta Doccia Strass 2
Ante 170 Vetro
Satinato Prof. Cromo



Codice	Riferimenti	Off.	Listino A	Listino B
PS2A1500218	148<>152	1	312,43 €	331,17 €
PS2A1600218	158<>162	1	325,18 €	344,69 €
PS2A1700218	168<>172	1	337,93 €	358,21 €
PS2A1800218	178<>182	1	364,35 €	386,21 €



Porta Doccia Strass 1
Anta 80 Vetro
Satinato Prof. Cromo



Codice	Riferimenti	Off.	Listino A	Listino B
PS1A700218	68<>72	1	191,28 €	202,76 €
PS1A750218	73<>77	1	197,66 €	209,52 €
PS1A800218	78<>82	1	204,03 €	216,28 €
PS1A900218	88<>92	1	213,60 €	226,41 €

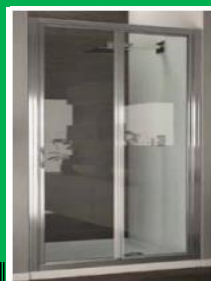

Porta Doccia Book5 2
Ante 90 Vetro
Temperato 5 Mm
Trasparente

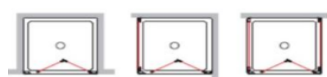

Codice	Riferimenti	Off.	Listino A	Listino B
PB700218	68<>72	1	255,04 €	270,35 €
PB750218	73<>77	1	258,23 €	273,72 €
PB800218	78<>82	1	264,61 €	280,48 €
PB900218	88<>92	1	270,98 €	287,24 €
PB1000218	98<>102	1	280,55 €	297,38 €



Porta Doccia Strass 2
Ante 90 Vetro
Trasparente Prof.

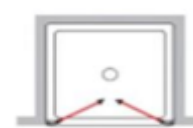

Codice	Riferimenti	Off.	Listino A	Listino B
PS2B700218	70 cm	1	191,28 €	202,76 €
PS2B750218	75 cm	1	200,85 €	212,90 €
PS2B800218	80 cm	1	209,50 €	222,07 €
PS2B900218	90 cm	1	220,43 €	233,66 €
PS2B1000218	100 cm	1	229,54 €	243,31 €



Serie Jubilaeum

AZZURRA
riscopri la purezza

Codice	Riferimenti	Off.	Listino A	Listino B
JUVCTP000000	Vaso	1	202,42 €	202,42 €
JUBITOB0000M	Bidet	1	202,42 €	202,42 €



Vaso Scarico Terra S/Europa

Codice	Riferimenti	Off.	Listino A	Listino B
CNVW3200S	Vaso Scarco Terra	1	65,22 €	65,22 €



Serie fast

AZZURRA
riscopri la purezza

Codice	Riferimenti	Off.	Listino A	Listino B
FABITM	Vaso	1	97,59 €	97,59 €
FAVCTP	Bidet	1	97,59 €	97,59 €



Bidet S/Europa

Codice	Riferimenti	Off.	Listino A	Listino B
CNVBD3200	Bidet	1	54,84 €	54,84 €



Serie Cult

3 Lt
AZZURRA
riscopri la purezza

Codice	Riferimenti	Off.	Listino A	Listino B
CLZ100B4P	Vaso	1	102,02 €	102,02 €
CLZ500B4	Bidet	1	102,02 €	102,02 €



Lavabo Corinto Cm 48X27 S/Foro

Codice	Riferimenti	Off.	Listino A	Listino B
AVB4	Lavabo	1	50,10 €	50,10 €



Serie Glaze

AZZURRA
riscopri la purezza

Codice	Riferimenti	Off.	Listino A	Listino B
GLZ100P	Vaso	1	166,94 €	166,94 €
GLZ500B4	Bidet	1	166,93 €	166,93 €



Labavo Corinto Cm. 58X45

Codice	Riferimenti	Off.	Listino A	Listino B
AVB6	Lavabo	1	50,10 €	50,10 €



Lavabo Corinto Cm 440x380x200

Codice	Riferimenti	Off.	Listino A	Listino B
AVB3	Lavabo	1	50,10 €	55,61 €



Lavabo Soprapiano

Codice	Riferimenti	Off.	Listino A	Listino B
TATZASW	Lavabo	1	138,45 €	138,45 €



Lavabo Sottopiano Largo 580 Profondo 360 "Zz"

Codice	Riferimenti	Off.	Listino A	Listino B
TATZAVW	Lavabo	1	115,68 €	115,68 €



VASO CIVITA
P.360X480X405 IN
CERAMI CA BIANCO
SCARICO PARETE

made in india



PROMO

Codice	Riferimenti	Off.	Listino A	Listino B
VSPPB	360x480x405	1	50,60 €	50,60 €
SAT1750	Copriwater	1	34,08 €	34,08 €



Lavabo Civita
605x460x175 mmin
Ceramica Bianco
Lucido

made in india



PROMO

Codice	Riferimenti	Off.	Listino A	Listino B
LUPB60	605x460x175	1	50,60 €	50,60 €
LUPB65	650x552x190	1	50,60 €	50,60 €



Vaso Civita Scarico
Terra 360x475x400
mm in Ceramica
Bianco Lucido

made in india



PROMO

Codice	Riferimenti	Off.	Listino A	Listino B
VSTPB	360x480x405	1	50,60 €	50,60 €
SAT1750	Copriwater	1	34,08 €	34,08 €



Colonna per lavabo
in ceramica Bianca

made in india



PROMO

Codice	Riferimenti	Off.	Listino A	Listino B
CLUPB	195x195x690	1	50,60 €	50,60 €



Bidet Civita
365x525x400 mm in
Ceramica Bianco
Lucido

made in india



PROMO

Codice	Riferimenti	Off.	Listino A	Listino B
BUPB	Bidet	1	50,60 €	50,60 €



Cassetta Alta Civita
435x250x325 mm in
Ceramica Bianco
Lucido

made in india



PROMO

Codice	Riferimenti	Off.	Listino A	Listino B
CAPB	435x250x325	1	37,95 €	37,95 €



Pila in Porcellana
bianca 60X50X40

made in india



PROMO

Codice	Riferimenti	Off.	Listino A	Listino B
AS03	60X50X40	1	126,51 €	126,51 €



Buttatoio Kg.13 Cm.
42X38

made in india



PROMO

Codice	Riferimenti	Off.	Listino A	Listino B
AS01	380x470x250	1	88,56 €	88,56 €

Piatto doccia EASY STONE

Piatto doccia rettangolare completa di piletta sifonata 90x120.

Effetto Pietra. Sp. 2,5 cm.

Colore Bianco

PROMO

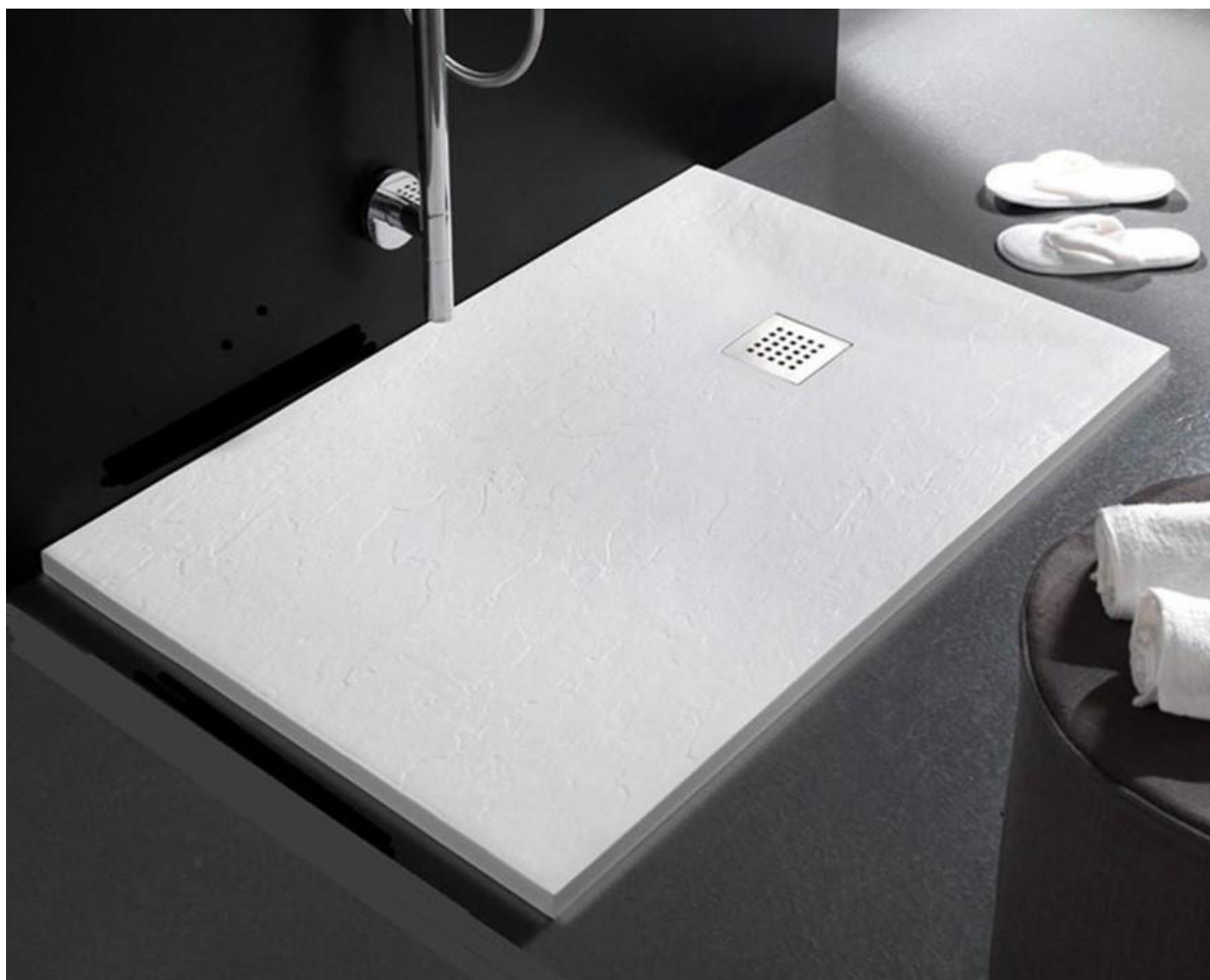

Codice Csr	Codice	Colore	Misura	Descrizione	Pz	Rif.	Listino A	Listino B
720090070		Bianco	70x90 cm	Piatto doccia EASY	1	1	181,38 €	201,33 €
720100070		Bianco	70x100 cm	Piatto doccia EASY	1	1	187,01 €	234,86 €
720120070		Bianco	70x120 cm	Piatto doccia EASY	1	1	205,79 €	276,42 €
720140070		Bianco	70x140 cm	Piatto doccia EASY	1	1	232,04 €	317,99 €
720160070		Bianco	70x160 cm	Piatto doccia EASY	1	1	238,45 €	316,70 €
720170070		Bianco	70x170 cm	Piatto doccia EASY	1	1	246,44 €	363,71 €
720100080		Bianco	80x100 cm	Piatto doccia EASY	1	1	195,32 €	286,82 €
720120080		Bianco	80x120 cm	Piatto doccia EASY	1	1	218,79 €	311,76 €
720140080		Bianco	80x140 cm	Piatto doccia EASY	1	1	245,20 €	353,32 €
720160080		Bianco	80x160 cm	Piatto doccia EASY	1	1	271,38 €	346,40 €
720170080		Bianco	80x170 cm	Piatto doccia EASY	1	1	271,49 €	390,37 €

AIRGAMA

Componenti interne / Inner parts

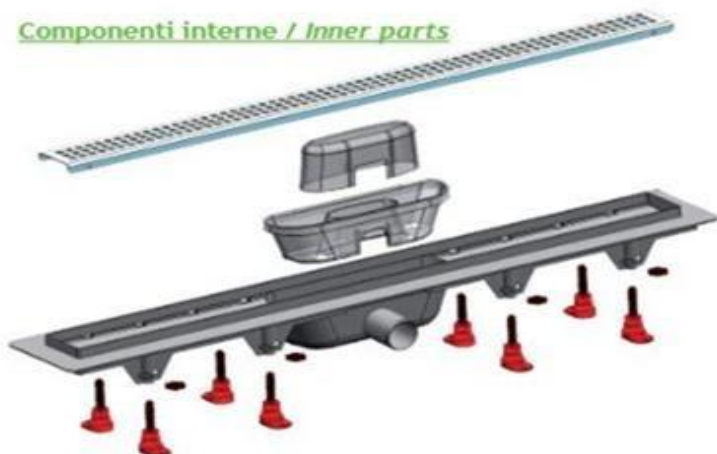

Imballo singolo
1 Channel per box



Design ricercato / Innovative design



Sifone interno / inner siphon



Guaina impermeabilizzante / Waterproof tape



Piedini regolabili / Adjustable height



Codice	Descrizione	D.	L	H	Pz	Rif.	Listino A	Listino B
CDG390NX40	griglia	40	390	66	1	1	164,53 €	182,63 €
CDG650NX40	griglia	40	650	66	1	1	181,43 €	201,39 €
CDG75SNX4050	griglia	40	750	66	1	1	156,57 €	173,79 €
CDG85SNX4050	griglia	40	850	66	1	1	167,75 €	186,20 €
CDP390NX40	piana	40	390	66	1	1	135,18 €	150,05 €
CDP650NX40	piana	40	650	66	1	1	126,38 €	140,28 €
CDP75VNX4050	piana	40	750	66	1	1	167,75 €	186,20 €
CDP85VNX4050	piana	40	850	66	1	1	180,66 €	200,53 €

PROFESSIONALITA' E QUALITA'

**EVOKlima**™

TECNOLOGIA - BENESSERE - RISPETTO PER L'AMBIENTE

WWW.EVOKLIMA.IT

PRESENTE NELLA PIATTAFORMA

www.edrcsr.it

Tutto per la casa dalla a alla z

La Piattaforma
Rivolta
ai rivenditori

e professionisti del Settore

Gruppo C. S. R. s. r. l. unipersonale

Deposito Zona Industriale Asi contrada San Benedetto Aragona (AG)

Email: edrcsr@gmail.com Info@evoklima.it Tel. 09221801565

Responsabile magazzino agrigento Alessio Conti +39 328 202 6997